



# OILLESS AIR COMPRESSOR OWNER'S MANUAL

**WARNING**   
**COMPRESSOR DISCHARGE AIR MAY CONTAIN HYDROCARBONS AND OTHER  
CONTAMINANTS! DO NOT USE DISCHARGE AIR FOR BREATHING!**

## PARTS

Genuine ROLAIR replacement parts are sold nationwide through a network of authorized dealers and service centers. Please contact the dealership where your air compressor was purchased or our factory Customer Service Department if you need help troubleshooting, obtaining parts, or locating an authorized ROLAIR service representative.

- To order replacement parts:
1. Give compressor model number
  2. Give compressor serial number
  3. Name of part
  4. Part number
  5. Quantity required

## RECORD OF PERTINENT INFORMATION

Make a permanent record of the model and serial number of your new air compressor here. You'll save time and expense by including this reference information when requesting service or replacement parts.

Place & Date of Purchase	Volts
Model	HZ
Serial #	HP

With the tank gauge at 0 PSI and air line(s) disconnected, close drain valve(s) and record the amount of time it takes to build tank pressure on the space provided. Periodically test your air compressor against this pump-up time to determine if it is operating correctly. If time test is considerably off, contact your local ROLAIR representative to arrange service.

From 0 to _____ *PSI Date            Min            Sec	From 0 to _____ *PSI Date            Min            Sec
--	--



# TABLE OF CONTENTS

Introduction and Definitions of Safety Warnings-----	2
Safety Warnings – Risk of Asphyxiation & Bursting-----	3
Safety Warnings – Risk of Electrocutation, Shock, Explosion, & Fire-----	3
Safety Warnings – Risk of Moving Parts, Burns, & Lifting-----	4
Safety Warnings – Risk of Propelled Objects, Unsafe Operation, and Damage----- To Compressor or Property	4
Identification of System Controls-----	5-6
Pre-Start Checklist-----	7
Operation-----	8
Maintenance-----	9-10
Troubleshooting-----	11
Guarantee-----	12

## INTRODUCTION



Congratulations on the purchase of your new ROLAIR air compressor!

With over 50 years experience building ROLAIR air compressors specifically designed for the professional, Associate Engineering Corporation has earned a reputation for providing a product unsurpassed in quality and reliability. We are committed to continuing this tradition by analyzing and adapting to the changing needs and rigorous demands of your industry. You can depend on ROLAIR because they are built to last.

This manual was compiled for the benefit of the operator. Do not use or allow anyone else to use your air compressor until this manual is read and all safety/operating instructions are understood. By reading and following the instructions contained in this manual, you can achieve years of trouble free service from your new air compressor. If you have any additional safety or operating questions after reading this manual, please contact your distributor or our customer service department. Do not remove or paint over any of the warning decals attached to the compressor.

### Definitions – Safety Warnings

Safety symbols are used throughout this manual to alert you to potentially hazardous situations. The following definitions describe the level of severity for each signal word.

- |  |                 |  |
|--|-----------------|--|
|  | <b>DANGER:</b>  | Indicates an imminently hazardous situation which, if not avoided, <u>WILL</u> result in <u>death or serious injury</u> .                                |
|  | <b>WARNING:</b> | Indicates a potentially hazardous situation which, if not avoided, <u>COULD</u> result in <u>death or serious injury</u> .                               |
|  | <b>CAUTION:</b> | Indicates a potentially hazardous situation which, if not avoided, <u>MAY</u> result in <u>minor or moderate injury</u> or damage to the air compressor. |



**WARNING**







The engine exhaust from this product contains chemicals known to the State of California to cause cancer, birth defects or other reproductive harm.

**WARNING**







Do not start, operate or service machine until you read and understand operator's manual. Failure to do so could result in serious injury.

## SAFETY WARNINGS

READ AND UNDERSTAND ALL SAFETY WARNINGS BEFORE USING AIR COMPRESSOR

Hazard Level	Potential of Hazard	How to Avoid Hazard
 <b>Risk of Asphyxiation</b>	Serious injury or death may occur from inhaling compressed air. The air stream may contain carbon monoxide, toxic vapors, or solid particles.	Never inhale compressed air directly from the pump, receiver, or from a breathing device connected to the air compressor.
	Sprayed materials such as paint, stucco, insecticides, solvents, etc. contain harmful vapors and poisons that may cause serious injury or death if inhaled.	Operate compressor only in a well-ventilated area. Use a respirator device and follow the manufacturer's recommendations for their spray equipment. Keep compressor at least 25 feet away from spray equipment.
	Serious injury or death may occur if the exhaust from gas-powered small engines is inhaled. Engine exhaust fumes contain poisonous, carbon monoxide which is odorless and colorless.	Operate gas-powered compressors only in a well-ventilated area. Avoid inhaling engine exhaust fumes, and never run a small gas-powered engine in a closed building or confined area without adequate ventilation.
 <b>Risk of Bursting</b>	Serious injury or death may occur from an air tank explosion if the air tanks are not properly maintained or if modifications, alterations or repairs are attempted to the air receivers.	Drain air tanks daily or after each use. Never drill into, weld, patch or modify the air tanks. If a leak develops, replace the tank immediately or replace the entire compressor.
	Serious injury or death may occur if modifications are made to the pilot unloader valve, pressure switch, safety relief valve or other components that control the tank pressure.	Never make adjustments to the components that control tank pressure. Do not make alterations to the factory operating pressure settings. Check operation of the safety valve on a regular basis and never operate without a factory approved safety valve.
	Serious injury may occur if accessories or attachments are operated above the manufacturer's recommended pressure ratings, causing them to explode or fly apart.	Do not use air tools or attachments before reading the owner's manual to determine the maximum pressure recommendations. Never exceed the manufacturer's maximum allowable pressure ratings. Do not use compressor to inflate small low pressure objects such as toys.
  <b>Risk of Electrocution or Electrical Shock</b>	Serious injury or death could occur if the air compressor is not properly grounded.	Always plug compressor into a properly grounded outlet which provides correct voltage, proper grounding and adequate fuse protection.
	Electrical shock may occur if compressor is not properly operated.	Never operate air compressor in wet conditions or outdoors when it's raining. Do not allow electric cords to lay in water. Do not operate with damaged power cord or with protective electrical covers removed. Do not touch plug with wet hands. Do not pull on electric cord to disconnect from the outlet.
	Serious injury or death may occur if electrical repairs are attempted by unqualified personnel.	Any electrical repairs or wiring performed on this compressor should only be performed by authorized service personnel in accordance with the National and Local Electric Codes.
  <b>Risk of Explosion or Fire</b>	Serious injury or death may result from normal electrical sparks that occur within the motor and/or pressure switch.	Always operate compressor in a well-ventilated area free of combustible materials, gasoline, flammable solvents or vapors. Always locate compressor at least 20 feet away from work area if spraying flammable materials.
	Serious injury may occur if a fire is caused by overheating due to inadequate ventilation or restrictions to any of the compressors ventilation openings.	Never place objects against or on top of an air compressor. Always operate air compressor at least 18" away from any wall or obstruction. Always operate in a clean, dry and well-ventilated area.
	Serious injury or death may occur from a fire or explosion if spilled gas or vapors come in contact with hot engine parts and ignite.	Never attempt to fill the gas tank while the engine is hot or running. Add fuel outdoors in a well-ventilated area. Do not fill gas tank near lit cigarettes or near other sources of ignition.

# SAFETY WARNINGS (con't)

 <b>Risk from Moving Parts</b>	<p>Serious injury may occur from moving parts such as belts, pulleys, flywheels or fans if they came in contact with you or your clothing.</p>	<p>Never operate the air compressor without protective belt guards installed. Replace damaged protective covers or guards immediately.</p>
	<p>An electric air compressor with automatic controls can restart at any time and cause bodily injury when least expected.</p>	<p>Always unplug air compressor and drain air tanks completely before attempting any repairs or performing maintenance. Never allow children or adolescents to operate air compressor.</p>
	<p>Serious injury may occur if repairs are attempted with damaged, missing or removed protective guards, shrouds or missing covers.</p>	<p>All repairs to the air compressor should be made only by authorized or trained service personnel.</p>
 <b>Risk of Burn</b>	<p>Serious burn injuries could occur from touching exposed metal parts such as the compressor head, copper/braided discharge lines and engine exhaust muffler during operation, and even after compressor is shut down for sometime.</p>	<p>Never touch any of the exposed metal parts during operation and for an extended period of time after the air compressor has shut down. Do not attempt maintenance on the unit until it has been allowed to completely cool.</p>
 <b>Risk of Injury from Lifting</b>	<p>Serious injury can result from attempting to lift an object that is too heavy.</p>	<p>Always obtain assistance from others before attempting to lift any object that is too heavy for one person.</p>
 <b>Flying Objects</b>	<p>Serious injury may occur from loose debris being propelled at high speeds from the compressed air stream.</p>	<p>Always wear OSHA required "287" safety glasses to protect the eyes during operation of the air compressor. Never point the air stream or tools at any point of your body, other people or animals.</p> <p>Always turn off the air compressor and drain tank pressure completely before attempting maintenance or attaching air tools.</p>
 <b>Warning</b> <b>Risk of Unsafe Operation</b>	<p>Serious injury or death may occur to you or others if air compressor is used in an <u>unsafe</u> manner.</p>	<p>Review and understand all instructions and warnings in your owner's manual. Know how to stop the air compressor. Do not operate until you are thoroughly familiar with all of the controls. Do not operate the compressor if fatigued or under the influence of alcohol or drugs. Stay alert while operating the compressor and pay close attention to the task at hand.</p>
 <b>Caution</b> <b>Risk of Damage to Air Compressor or Property</b>	<p>Failure to transport or operate the air compressor properly may result in major repair expenses. Oil leaks will damage carpets, painted surfaces, flooring and other items.</p>	<p>Check oil levels daily and maintain proper oil levels. Always run compressor in a level, secure position that keeps it from tipping or falling during use. Do not operate without an air filter or in a corrosive environment.</p> <p>Always transport in a level position and use protective mats to keep truck beds clean, etc. Check drain bolts regularly and do not overfill machinery with oil.</p>

Please note that this product may not be equipped with a spark arresting muffler. If the compressor is operated around flammable materials or agricultural crops, brush, forests, and grasslands an approved spark arrestor must be installed, maintained and in good working order. An approved spark arrestor is legally required in the State of California under sections 4442 and 4443 of the California Public Resources Code Statute section 130050.

This product contains chemicals, including lead, known to the state of California to cause cancer, birth defects, and other reproductive harm. Always wash hands after handling this product.

# SYSTEM CONTROLS

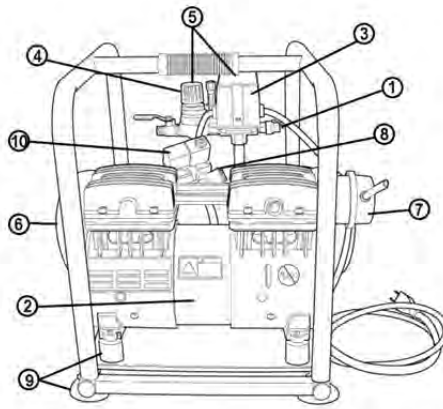

(1) **SAFETY-RELIEF VALVE** Every ROLAIR air compressor is equipped with a safety-relief valve which is designed to discharge tank pressure at a predetermined setting when a systems failure occurs. Check the safety valve periodically by pulling on the ring only when the tank pressure is completely drained. The spring loaded valve should move freely within the safety valve body. An inoperable safety valve could allow an excessive amount of tank pressure to build causing the air tank to catastrophically rupture or explode.

 **Do not tamper with or attempt to eliminate the safety relief valve.**

(2) **MOTOR OVERLOAD PROTECTION** Every ROLAIR electric air compressor is equipped with thermal overload protection. If the motor overheats, an overload sensor will either trip a reset button or automatically break the circuit to protect the motor. Whenever your air compressor unexpectedly stops running, unplug the power cord, drain the tank pressure completely and allow the motor to cool for five to ten minutes before attempting to restart. Motors built with manual overload protection will trip a reset button that must be physically pressed or pushed back into its original position before the motor can be restarted. Also note that motors with automatic overload protection will attempt to restart if still plugged in, whenever the motor has sufficiently cooled. Always unplug the compressor and drain tank pressure before attempting any type of repair.

The use of an undersized or excessive length of extension cord may be the cause of overheating. Always re-evaluate the power source and gauge/length of extension cord being used when the motor overload stops the normal operation of your air compressor. (Refer to chart on page 8.)

 **Motors with automatic overload protection can restart at any time.**

(3) **PRESSURE SWITCH** Most electric air compressors are operated by the use of a pressure switch. Always make sure the lever is in the "Off" position before plugging in the power cord. By moving the lever to the "On/Auto" position, the compressor will start and stop automatically within the settings of the pressure switch. Do not attempt to stop the compressor by unplugging the power cord. To stop, simply move the lever to the "Off" position.

(4) **REGULATOR – WORKING PRESSURE** To adjust the output/line pressure, simply rotate the regulator adjustment knob clockwise to increase working pressure or counterclockwise to decrease. Never exceed the manufacturer's maximum allowable pressure rating of the tool being used or item being inflated.

(5) **PRESSURE GAUGE(S)** Typically, most compressors are designed with a gauge to measure tank or storage pressure and another gauge attached to the regulator that indicates output or working pressure.

(6) **DRAIN VALVE(S)** One or more drain valves are installed to allow moisture to be drained on a daily basis from the compressor storage tank(s). Open drains carefully and slowly to prevent scale, rust, or debris from becoming expelled at a high rate of speed.

(7) **AIR INTAKE FILTER** Air intake filters are installed to prevent foreign matter from entering the engine or compressor pump. Check intake elements on a regular basis and either clean or replace as needed. Warm soapy water or low compressed air may be used to clean the elements. Check intake canisters or elbow components for cracks or broken seals and replace if structural problems are found.

(8) **CHECK VALVE** Every ROLAIR air compressor is built with a check valve to seal off and maintain tank pressure after the top end setting of pressure switch is reached. The check valve works in conjunction with the solenoid relief valve to provide a *load-less* start for the compressor system. A quick burst of air escaping from the solenoid valve after the unit reaches top end indicates the check valve is working properly. If the compressor has a mysterious leak after stopping that cannot be traced elsewhere, the check valve may require servicing/replacing.

(9) **VIBRATION DAMPENER(S)** The rubber pads installed beneath every portable ROLAIR tank assembly are very important to the proper operation of the air compressor. They provide protection from vibration that left unchecked could cause damage to many system components. Always maintain the vibration dampeners on your air compressor.

(10) **SOLENOID VALVE** Your JC10 air compressor is equipped with an electronic solenoid valve which dumps head pressure when your machine reaches top pressure or is unplugged. This type of unloading system provides a load-less restart when the motor overload trips or even if your machine is unplugged while still building tank pressure.

## PRE-START CHECKLIST

Read the owner's manual thoroughly. Make sure that you completely understand all of the safety warnings, system controls and instructions provided before attempting to operate this air compressor. Every effort has been made to provide you with the information needed to obtain many years of reliable and trouble-free service out of your new air compressor. It is your responsibility to operate the air compressor properly. To obtain the longest possible service life from your air compressor you must always keep the following instructions in mind.

1. **OPERATE IN A CLEAN, DRY AND WELL VENTILATED AREA**

Allow at least 18" behind the belt guard for proper cooling of pump from flywheel blast. Do not operate in the rain or in areas of standing water. Never operate in an area where other gases, fumes or vapors are present which may become explosive when compressed. Do not operate compressor in an enclosed area.

2. **INSPECT/CLEAN/CHANGE INTAKE ELEMENTS ON A REGULAR BASIS**

The ingestion of dirt into the pump and engine is the primary cause of premature wear. Pay special attention to the intake filters. Check intake filters daily.

3. **USE LONGER PROPERLY SIZED AIR HOSE RATHER THAN EXTENSION CORDS**

If an extension cord must be used, please refer to the chart below for the proper gauge and maximum length that can be used. The use of inadequately sized air hose will also lead to frictional pressure drops that could affect the proper performance of your air tools.

4. **DO NOT USE A GENERATOR AS THE POWER SOURCE**

Air compressors use inductive motors that require 3-5 times the full-load amp draw to properly start. Most generators will not provide the wattage needed to properly start this type of electric motor.

5. **CHECK TENSION OF BOLTS, BELTS, AND HARDWARE ON A REGULAR BASIS**

Operation of any equipment with loose bolts and/or fittings will lead to excessive vibration and the premature failure of the compressor system control components.

6. **MAINTAIN RUBBER VIBRATION PADS**

Excessive vibration is a major cause of premature compressor failure. Always maintain the rubber vibration pads located beneath tank assembly. Operation without them will void your warranty.

7. **DRAIN MOISTURE FROM AIR TANKS DAILY**

Water is a natural byproduct of compressed air. Drain air tank(s) after each use to combat internal tank corrosion. Keep drain valve(s) closed if storing compressor for any length of time.

### **ELECTRIC EXTENSION CORD TABLE**

<b>Minimum Wire Size</b>		
<b>Extension Cord Length</b>	<b>Motor 1/2 and 3/4 HP</b>	<b>Motor 1, 1-1/2, and 2 HP</b>
<b>Up to 25 ft.</b>	<b>14 Ga.</b>	<b>12 Ga.</b>
<b>25 – 50 ft.</b>	<b>12 Ga.</b>	<b>10 Ga.</b>
<b>50 – 100 ft.</b>	<b>10 Ga.</b>	<b>8 Ga.</b>

## OPERATION

**WARNING** – Your safety and the wellbeing of others during the operation of every ROLAIR compressor is our main concern. Do not operate or permit anyone else to operate your air compressor until the information contained in this manual is read and completely understood. Please contact your distributor or our customer service department if you have any questions on the proper use of your air compressor.

### DIRECT-DRIVE ELECTRIC

Establish that the air compressor is ready to operate by reviewing the topics and information provided in the “Pre-Start Checklist” section of this manual. Slowly open tank drain to remove any condensate that has accumulated and keep drain open for a few seconds after starting to warm up motor/pump assembly. Make sure the pressure switch lever is in the “Off” position before plugging power cord into a properly grounded outlet. Move pressure switch lever to the “On/Auto” position to build and automatically maintain top end tank pressure setting. Rotate regulator adjustment knob counterclockwise until the gauge attached reads 0 PSI before attaching air hose and accessory. Set working pressure by rotating regulator adjustment knob clockwise and lock in working pressure according to specifications provided by the tool manufacturer. Always use the pressure switch “On(Auto)/Off” lever to start or stop the air compressor. **Never** stop the compressor by unplugging it from the power source. Store compressor in a warm/dry location and perform maintenance as indicated in manual.

## MAINTENANCE

Your new air compressor represents the finest engineering and construction available. Even the best machinery requires periodic maintenance. Please stick to the maintenance schedule and consider the suggestions that follow to keep your compressor in peak condition.

**NOTE: Always unplug or shut down your compressor and drain the air tanks completely before attempting any type of maintenance. Wait for compressor to cool before servicing.**

### MAINTENANCE HINTS:

- 1) Use a soap/water solution to check for air leaks.
- 2) Never clean filters with a flammable solvent.
- 3) Retorque head bolts only after pump has cooled.
- 4) Never weld on air tank(s).
- 7) Use heat to loosen Loctite seal on drain valves, engine pulleys, and flywheels before attempting to remove.

### MAINTENANCE SCHEDULE

<b>Recommendation</b>	<b>Daily</b>	<b>Weekly</b>	<b>Monthly</b>	<b>Quarterly</b>
Drain Moisture from Tank(s)	X			
Inspect Air Filter(s)	X			
Check for Unusual Noise or Vibration	X			
Inspect Guards	X			
Check for Air Leaks	X			
Clean Exterior of Air Compressor		X		
Check Condition of Vibration Pads		X		
Tighten/Retorque Bolts		X		
Check Operation of Safety Valve		X		
Clean/Change Air Filter			X	
Perform Pump Up Time Test			X	
Check Operation of System Controls				X
Check Air Tanks for Dents/Leaks				X

## TROUBLESHOOTING

**WARNING** - Make sure you completely understand all of the safety warnings and operation of each system control component before attempting any maintenance or repair. Always drain the tank pressure completely, make sure the power cord is unplugged, and unit has time to cool before performing any maintenance or service operations.

PROBLEM	CAUSE	SOLUTION
Pump is slow to build tank pressure	Excessive leaks in system	Correct air leaks
	Blown gasket	Replace head gaskets
	Broken reed valve	Replace reed valves
	Obstructed intake filter	Clean or replace intake element
	Leaking regulator	Replace regulator
Knocking noise	Internal pump problem	Take unit in for service
Overheating compressor	Poor ventilation	Relocate compressor
	Improper pump rotation	Contact an electrician
	Internal pump problem	Take unit in for service
Electric motor dead, will not even hum	Thermal overload tripped	Locate and push reset button
	Automatic overload has stopped motor	Unplug, drain pressure and wait 5-10 minutes before attempting to restart
	Reset physically broken	Replace overload/reset
	Loose motor leads or electrical connection	Locate and correct loose electrical connection(s)
	Short in power cord	Replace power cord
Motor trips overload/reset button	Motor is starting/stopping excessively	Install constant speed or dual control kit
	Overload is defective/weak	Replace overload
	Improper gauge of extension cord	Use longer lengths of air hose or heavier cord
	Stripped or poorly tightened motor thru bolts	Retighten or replace stripped thru bolts
	Cracks in end bell or housing	Take unit in for service

## SPECIFICATIONS

MODEL JC10	
Horsepower	1.0
Voltage	120 V
Hertz	60
Motor RPM	1680
Weight	39 lb.
Tank Size	2.3 gallons
Thermal Protection	Automatic
Dimensions	(L x W x H - inches)
Actual	15-5/8 x 16-3/4 x 14-3/4
Shipping	16-1/8 x 17-3/4 x 15-3/4
Cu. Ft. Delivered @ 40 PSI	3.8 CFM
Cu. Ft. Delivered @ 90 PSI	2.35 CFM
Decibels	60 dBA
Pump-Up Time (0-115 PSI)	45 seconds
Recovery Time (85-115 PSI)	11 seconds





## Guarantee

Associate Engineering Corporation warrants that all ROLAIR compressors will be free of defects in material and workmanship for a period of twelve months from the date of initial retail purchase, or eighteen months from the date of manufacture, whichever may occur first.

Should any failure to conform to this warranty be reported to the company within said period, the company shall, upon purchaser shipping the compressor to our plant transportation prepaid, correct such nonconformity by suitable repair or, at its option, furnish a replacement part F.O.B. our plant.

Associate Engineering Corporation shall not be liable for any unauthorized repairs, replacements, adjustments to the compressors, or the costs of labor performed by the purchaser.

**This warranty is expressly in lieu of all other warranties expressed, implied or statutory (including, but not limited to, warranties of merchantability and fitness for purpose) and of any other obligations, and/or liabilities on the part of Associate Engineering Corporation. Associate Engineering Corporation neither assumes nor authorizes any other person to assume for it any other obligations or liability in connection with or with respect to any compressor.**

Associate Engineering Corporation shall in no event be liable neither for any consequential, incidental or special damages nor for the improper selection of any compressor for a particular application.

## Quality

Associate Engineering Corporation is devoted to continual quality control and thorough research of the products we build. It is our creed to give you, the user, all of the experience and engineering available in the production of every piece of equipment we produce.

Our line covers the complete needs of today's varied air requirements. Rely on ROLAIR for all the newest and finest features that are available for the modern compressor.



# ROLAIR

## SCHEMATIC FOR MODEL JC10

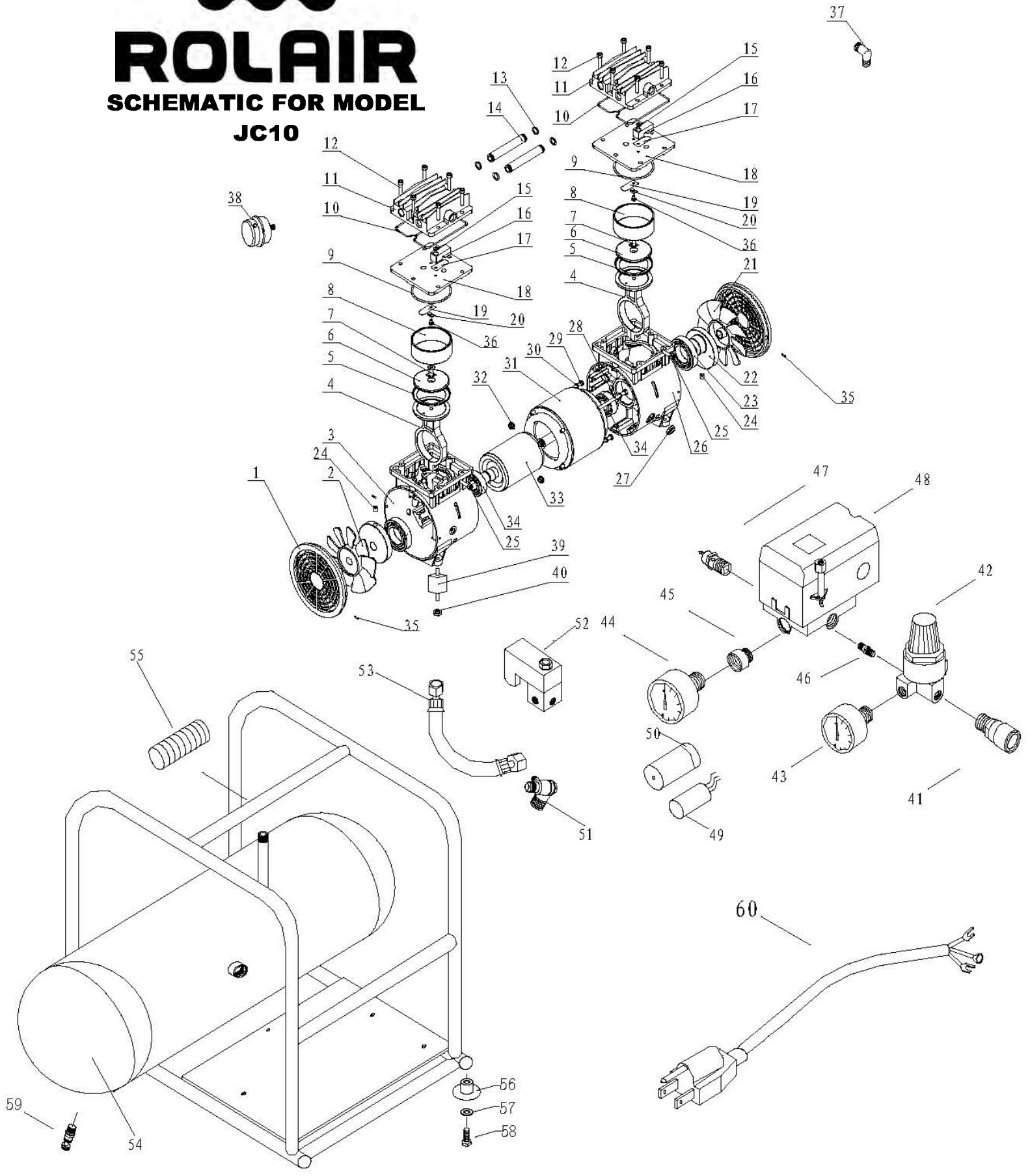



## PARTS LIST FOR MODEL JC10

Schem #	Description	Part #	Qty.	Schem #	Description	Part #	Qty.
1	Motor Cover	JC800-1	2	31	Stator	JC800-31	1
2	Fan (left side only)	JC800-2	1	32	Nut	JC800-32	4
3	Crankcase (left side only)	JC800-3	1	33	Rotor	JC800-33	1
4	Connecting Rod	JC800-4	2	34	Bearing	JC800-34	2
5	Piston Ring	JC800-5	2	35	Screw	JC800-35	4
6	Piston Cap	JC800-6	2	36	Screw	JC800-36	2
7	Cap Bolt	JC800-7	2	37	Elbow	JC800-37	1
8	Cylinder	JC800-8	2	38	Air Filter Assembly	JC800-38	1
9	O-Ring	JC800-9	2	39	Vibration Dampener	JC800-39	4
10	Head Gasket	JC800-10	2	40	Nut	JC800-40	4
11	Head	JC800-11	2	41	Coupler	JC800-41	1
12	Head Bolt	JC800-12	12	42	Regulator	JC800-42	1
13	O-Ring	JC800-13	4	43	Gauge – Line	JC800-43	1
14	Connecting Tube	JC800-14	2	44	Gauge – Tank	JC800-44	1
15	Bolt	JC800-15	2	45	Bushing	JC800-45	1
16	Valve Stop	JC800-16	2	46	Nipple	JC800-46	1
17	Valve – Exhaust	JC800-17	2	47	Safety Relief Valve	JC800-47	1
18	Valve Plate	JC800-18	2	48	Pressure Switch	JC800-48	1
19	Valve – Intake	JC800-19	2	49	Capacitor	JC800-49	1
20	Washer	JC800-20	2	50	Cover – Capacitor	JC800-50	1
21	Fan (right side only)	JC800-21	1	51	Check Valve	JC800-51	1
22	Eccentric	JC800-22	2	52	Solenoid – Unloader	JC800-52	1
23	Bearing	JC800-23	2	53	Braided Discharge Line	JC800-53	1
24	Setscrew	JC800-24	2	54	Tank Assembly	JC800-54	1
25	Bolt – Con Rod	JC800-25	2	55	Handle Grip	JC800-55	1
26	Crankcase (right side only)	JC800-26	2	56	Rubber Foot	JC800-56	4
27	Box Connector	JC800-27	1	57	Washer	JC800-57	4
28	Bolt	JC800-28	2	58	Bolt	JC800-58	4
29	Bolt	JC800-29	2	59	Drain Valve	JC800-59	1
30	Washer	JC800-30	4	60	Cord with Plug	JC800-60	1

