

Modular/F.R.L. Units

Series AC



Round type pressure gauge (with color zone)

AC

AF□

AR

AL

AW□

A□G

AV

AF800
AF900



Modular F.R.L. Units Series AC

Improved visibility for lubricant drip with graduation for lubricant control

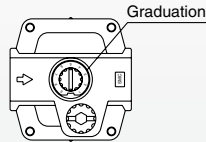

Spacer with bracket

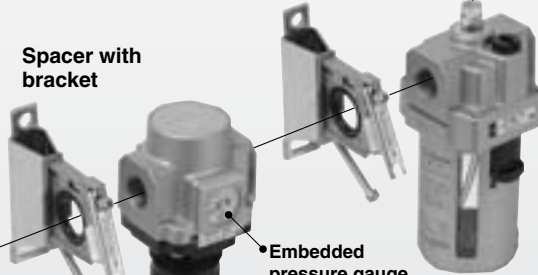

Embedded pressure gauge is a standard feature.

- Ozone resistant rubber material (HNBR)
- Improved relief sensitivity

• Float type auto drain with excellent operability is used for compact models (AF10/20). Drain cock is easy-to-use rotary type.

Improved installation

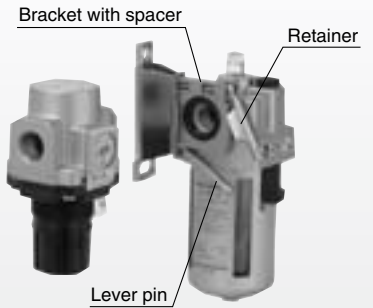

- ① Attach the component into the fitting of the spacer with bracket.
- ② Lock the lever pin into the retainer. (temporary installation)

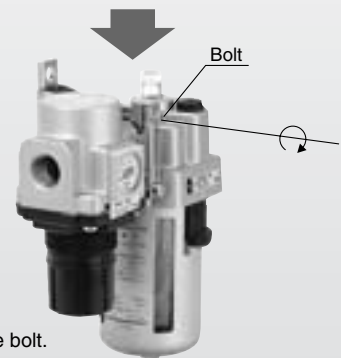

- ③ Tighten the bolt.

Round type pressure gauge (with color zone) type

■ Red and green zones offer improved visibility of pressure control range.

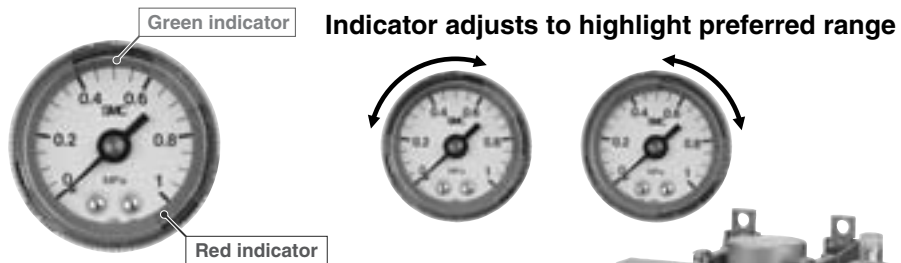

- Filter Regulator AW20(K) to 60(K)
- Mist Separator Regulator AWM20 to 40
- Micro Mist Separator Regulator AWD20 to 40







- Regulator AR20(K) to 60(K)

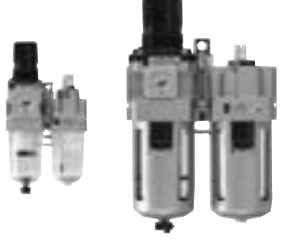

- F.R.L. Unit
 - AC20 to 60 (AF + AR + AL)
 - AC20A to 60A (AW + AL)
 - AC20B to 60B (AF + AR)
 - AC20C to 40C (AF + AFM + AR)
 - AC20D to 40D (AW + AFM)

Series Configuration

Product	Model	Port size							Page
		M5 x 0.8	1/8	1/4	3/8	1/2	3/4	1	
Air Filter + Regulator + Lubricator AF AR AL 	AC10	●							300
	AC20		●	●					
	AC25			●	●				
	AC30			●	●				
	AC40			●	●	●			
	AC40-06						●		
	AC50						●	●	
	AC55							●	
	AC60							●	
Filter Regulator + Lubricator AW AL 	AC10A	●							306
	AC20A		●	●					
	AC30A			●	●				
	AC40A			●	●	●			
	AC40A-06						●		
	AC50A						●	●	
	AC60A							●	
Air Filter + Regulator AF AR 	AC10B	●							310
	AC20B		●	●					
	AC25B			●	●				
	AC30B			●	●				
	AC40B			●	●	●			
	AC40B-06						●		
	AC50B						●	●	
	AC55B							●	
	AC60B							●	
Air Filter + Mist Separator + Regulator AF AFM AR 	AC20C		●	●					314
	AC25C			●	●				
	AC30C			●	●				
	AC40C			●	●	●			
	AC40C-06						●		
Filter Regulator + Mist Separator AW AFM 	AC20D		●	●					318
	AC30D			●	●				
	AC40D			●	●	●			
	AC40D-06						●		

Air Combination

AC

AF□

AR

AL





AW□

A□G





AV

AF800
AF900

Series Configuration

Product	Model	Port size							Page
		M5 x 0.8	1/8	1/4	3/8	1/2	3/4	1	
Air Filter 	AF	AF10	●						327
	AF20		●	●					
	AF30			●	●				
	AF40			●	●	●			
	AF40-06						●		
	AF50						●	●	
	AF60							●	
Mist Separator 	AFM	AFM20		●	●				338
	AFM30			●	●				
	AFM40			●	●	●			
	AFM40-06						●		
Micro Mist Separator 	AFD	AFD20		●	●				338
	AFD30			●	●				
	AFD40			●	●	●			
	AFD40-06						●		
Regulator 	AR	AR10	●						345
	AR20		●	●					
	AR25			●	●				
	AR30			●	●				
	AR40			●	●	●			
	AR40-06						●		
	AR50						●	●	
	AR60							●	
Regulator with Backflow Function 	AR□K	AR20K		●	●				345
	AR25K			●	●				
	AR30K			●	●				
	AR40K			●	●	●			
	AR40K-06						●		
	AR50K						●	●	
	AR60K							●	

Series Configuration

Product	Model	Port size							Page	
		M5 x 0.8	1/8	1/4	3/8	1/2	3/4	1		
Lubricator 	AL	AL10	●						357	
		AL20		●	●					
		AL30			●	●				
		AL40			●	●	●			
		AL40-06						●		
		AL50						●		●
		AL60								●
Filter Regulator 	AW	AW10	●						365	
		AW20		●	●					
		AW30			●	●				
		AW40			●	●	●			
		AW40-06						●		
		AW60						●		●
Filter Regulator with Backflow Function 	AW□K	AW20K		●	●				365	
		AW30K			●	●				
		AW40K			●	●	●			
		AW40K-06						●		
		AW60K						●		●
Mist Separator Regulator 	AWM	AWM20		●	●				378	
		AWM30			●	●				
		AWM40			●	●	●			
Micro Mist Separator Regulator 	AWD	AWD20		●	●				378	
		AWD30			●	●				
		AWD40			●	●	●			

Simple Specials System

A system designed to respond quickly and easily to your special ordering needs.

Simple
Specials
 System

Short lead times

This system enables us to respond to your special needs, such as additional machining, accessory assembly, or modular unit, and deliver such special products as quickly as standard products.

Repeat orders

Once we receive a Simple Special part number from your previous order, we will process the order, manufacture the product, and deliver it to you.

AC

AF□

AR

AL

AW□

A□G

AV

AF800
AF900

AC10 to AC60

JIS Symbol



Air Filter Regulator Lubricator

How to Order

AC **30** - **03** **DE** - -

① ② ③ ④ ⑤ ⑥

- Option/Semi-standard: Select one each for a to m.
 - Option/Attachment/Semi-standard symbol: When more than one specification is required, indicate in alphanumeric order.
- Example) AC30-F03DE1-KSTV-136NR

		Symbol	Description	①								
				Body size								
				10	20	25	30	40	50	55	60	
②	Thread type	Nil	Metric thread (M5)	●	—	—	—	—	—	—	—	
		N ^{Note 1)}	Rc	—	●	●	●	●	●	●	●	
		F ^{Note 2)}	NPT	—	●	●	●	●	●	●	●	
			G	—	●	●	●	●	●	●	●	
+												
③	Port size	M5	M5	●	—	—	—	—	—	—	—	
		01	1/8	—	●	—	—	—	—	—	—	
		02	1/4	—	●	●	●	—	—	—	—	
		03	3/8	—	—	●	●	●	—	—	—	
		04	1/2	—	—	—	—	●	—	—	—	
		06	3/4	—	—	—	—	—	●	●	—	—
		10	1	—	—	—	—	—	—	●	●	●
+												
④	a	Float type auto drain	Nil	Without auto drain	●	●	●	●	●	●	●	●
			C	Float type auto drain (N.C.)	●	●	●	●	●	●	●	●
			D	Float type auto drain (N.O.)	—	—	●	●	●	●	●	●
	+											
	b	Pressure gauge	Nil	Without pressure gauge	●	●	●	●	●	●	●	●
			E	Square embedded type pressure gauge (with limit indicator)	—	●	●	●	●	●	●	●
			G	Round type pressure gauge (without limit indicator)	●	—	—	—	—	—	—	—
				Round type pressure gauge (with limit indicator)	—	●	●	●	●	●	●	●
		Digital pressure switch	M	Round type pressure gauge (with color zone)	—	●	●	●	●	●	●	●
			E1	Output: NPN output / Electrical entry: Wiring bottom entry	—	●	●	●	●	●	●	●
			E2	Output: NPN output / Electrical entry: Wiring top entry	—	●	●	●	●	●	●	●
	E3	Output: PNP output / Electrical entry: Wiring bottom entry	—	●	●	●	●	●	●	●		
	E4	Output: PNP output / Electrical entry: Wiring top entry	—	●	●	●	●	●	●	●		
	+											
⑤	c	Check valve	Nil	Without attachment	●	●	●	●	●	●	●	
			K	Mounting position: AF+AR+K+AL	—	●	●	●	● ^{Note 4)}	—	—	—
	+											
	d	Pressure switch	Nil	Without attachment	●	●	●	●	●	●	●	●
			S ^{Note 5)}	Mounting position: AF+AR+S+AL	—	●	●	●	●	●	●	●
	+											
	e	T-interface	Nil	Without attachment	●	●	●	●	●	●	●	●
			T ^{Note 5)}	Mounting position: AF+T+AR+AL	●	●	●	●	●	●	●	●
	+											
	f	3-port valve for residual pressure release	Nil	Without attachment	●	●	●	●	●	●	●	●
V			Mounting position: AF+AR+AL+V	—	●	●	●	●	—	—	—	
+												
⑥	g	Set pressure	Nil	0.05 to 0.85 MPa setting	●	●	●	●	●	●	●	
			1 ^{Note 6)}	0.02 to 0.2 MPa setting	●	●	●	●	●	●	●	
	+											
	h	Bowl ^{Note 7)}	Nil	Polycarbonate bowl	●	●	●	●	●	●	●	●
			2	Metal bowl	●	●	●	●	●	●	●	●
			6	Nylon bowl	●	●	●	●	●	●	●	●
			8	Metal bowl with level gauge	—	—	●	●	●	●	●	●
			C	With bowl guard	—	●	—	—	—	—	—	—
			6C	Nylon bowl with bowl guard	—	●	—	—	—	—	—	—

Air Combination Series AC10 to AC60

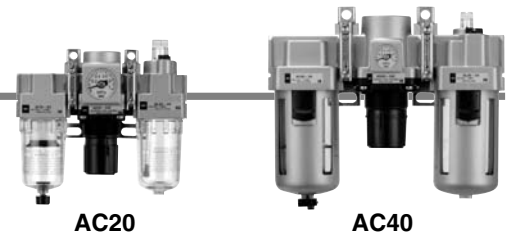

	Symbol	Description	① Body size								
			10	20	25	30	40	50	55	60	
6 Semi-standard	i Filter drain port ^{Note 8)}	Nil	With drain cock	●	●	●	●	●	●	●	●
		J ^{Note 9)}	Drain guide 1/8	—	●	—	—	—	—	—	—
			Drain guide 1/4	—	—	●	●	●	●	●	●
		W ^{Note 10)}	Drain cock with barb fitting: For ø6 x ø4 nylon tube	—	—	●	●	●	●	●	●
	+										
	j Lubricator lubricant exhaust port	Nil	Without drain cock	●	●	●	●	●	●	●	●
		3 ^{Note 11)}	Lubricator with drain cock	●	●	●	●	●	●	●	●
	+										
	k Exhaust mechanism	Nil	Relieving type	●	●	●	●	●	●	●	●
		N	Non-relieving type	●	●	●	●	●	●	●	●
	+										
	l Flow direction	Nil	Flow direction: Left to right	●	●	●	●	●	●	●	●
R		Flow direction: Right to left	●	●	●	●	●	●	●	●	
+											
m Pressure unit	Nil	Name plate and pressure gauge in imperial units: MPa	●	●	●	●	●	●	●	●	
	Z ^{Note 12)}	Name plate, caution plate for bowl, and pressure gauge in imperial units: psi, °F	○ ^{Note 14)}	○ ^{Note 14)}	○ ^{Note 14)}	○ ^{Note 14)}	○ ^{Note 14)}	○ ^{Note 14)}	○ ^{Note 14)}	○ ^{Note 14)}	
	ZA ^{Note 13)}	Digital pressure switch: With unit conversion function	—	△ ^{Note 15)}	△ ^{Note 15)}	△ ^{Note 15)}	△ ^{Note 15)}	△ ^{Note 15)}	△ ^{Note 15)}	△ ^{Note 15)}	

- Note 1) Drain guide is NPT1/8 (applicable to the AC20) and NPT1/4 (applicable to the AC25 to AC60). The auto drain port comes with ø3/8" one-touch fitting (applicable to the AC25 to AC60).
- Note 2) Drain guide is G1/8 (applicable to the AC20) and G1/4 (applicable to the AC25 to AC60).
- Note 3) Option G, M are not assembled and supplied loose at the time of shipment.
- Note 4) Not available with piping port size: 06.
- Note 5) The bracket position varies depending on the T-interface or pressure switch mounting.

- Note 6) The only difference from the standard specifications is the adjusting spring for the regulator. It does not restrict the setting of 0.2 MPa or more. When the pressure gauge is attached, a 0.2 MPa pressure gauge will be fitted.
- Note 7) Refer to Chemical Data on page 287 when selecting a case material.
- Note 8) Float type auto drain: The combination of C and D is not possible.
- Note 9) Without a valve function
- Note 10) Metal bowl: The combination of 2 and 8 is not possible.
- Note 11) Filter drain port: When choosing with W, the drain cock of a lubricator will be with barb fittings.

- Note 12) For thread type: M5 and NPT. This product is for overseas use only according to the new Measurement Law. (The SI unit type is provided for use in Japan.) The digital pressure switch will be equipped with the unit conversion function, setting to psi initially. MPa and psi are shown together on the pressure unit. The combination of the round type pressure gauge with color zone "M" and a psi display "Z" is not orderable as a standard product. However, this combination is available as a special.
- Note 13) For options: E1, E2, E3, E4. This product is for overseas use only according to the new Measurement Law. (The SI unit is provided for use in Japan.)
- Note 14) ○: For thread type: M5 and NPT only
- Note 15) △: Select with options: E1, E2, E3, E4.

Standard Specifications

Model	AC10	AC20	AC25	AC30	AC40	AC40-06	AC50	AC55	AC60	
Component	Air filter	AF10	AF20	AF30	AF30	AF40	AF40-06	AF50	AF60	AF60
	Regulator	AR10	AR20	AR25	AR30	AR40	AR40-06	AR50	AR60	AR60
	Lubricator	AL10	AL20	AL30	AL30	AL40	AL40-06	AL50	AL60	AL60
Port size	M5 x 0.8	1/8, 1/4	1/4, 3/8	1/4, 3/8	1/4, 3/8, 1/2	3/4	3/4, 1	1	1	
Pressure gauge port size ^{Note 1)}	1/16		1/8				1/4			
Fluid	Air									
Ambient and fluid temperature ^{Note 2)}	-5 to 60°C (with no freezing)									
Proof pressure	1.5 MPa									
Max. operating pressure	1.0 MPa									
Set pressure range	0.05 to 0.7 MPa	0.05 to 0.85 MPa								
Relief pressure	Set pressure + 0.05 MPa ^{Note 3)} [at relief flow rate of 0.1 l/min (ANR)]									
Nominal filtration rating	5 µm									
Recommended lubricant	Class 1 turbine oil (ISO VG32)									
Bowl material	Polycarbonate									
Bowl guard	—	Semi-standard	Standard							
Regulator construction	Relieving type									
Mass (kg)	0.27	0.46	0.91	1.00	1.74	1.95	4.17	4.25	4.34	

- Note 1) Pressure gauge connection threads are not available for F.R.L. unit with a square embedded type pressure gauge or with a digital pressure switch (AC20 to AC60).
- Note 2) -5 to 50°C for the products with the digital pressure switch
- Note 3) Not applicable to the AC10.

- AC
- AF□
- AR
- AL
- AW□
- A□G
- AV
- AF800
- AF900

Series AC10 to AC60

Flow Characteristics (Representative values)

Condition: Inlet pressure 0.7 MPa

AC10 M5 x 0.8

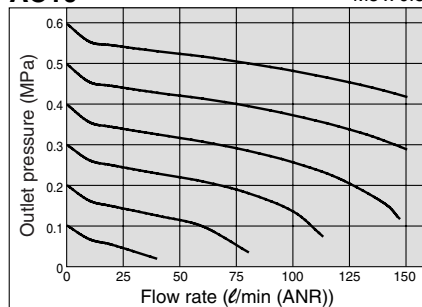

AC20 Rc1/4

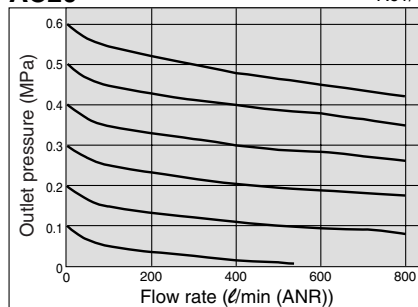

AC25 Rc3/8

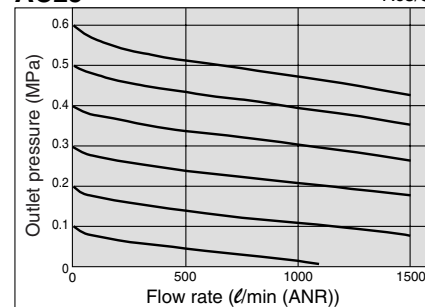

AC30 Rc3/8

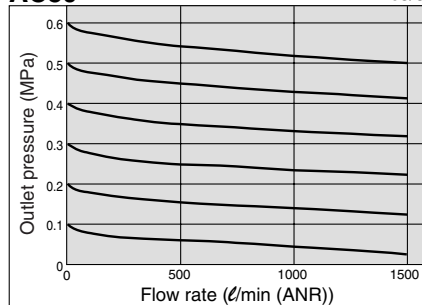

AC40 Rc1/2

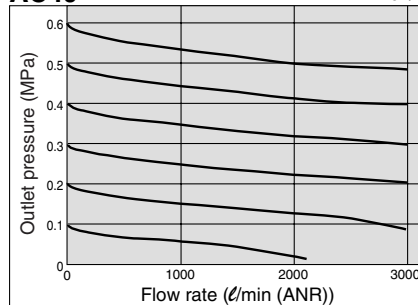

AC40-06 Rc3/4

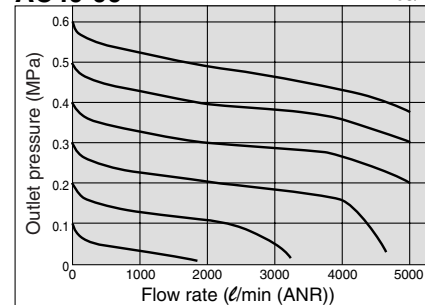

AC50 Rc1

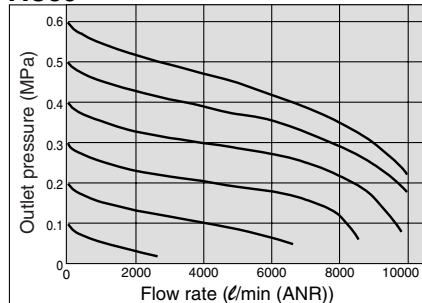

AC55 Rc1

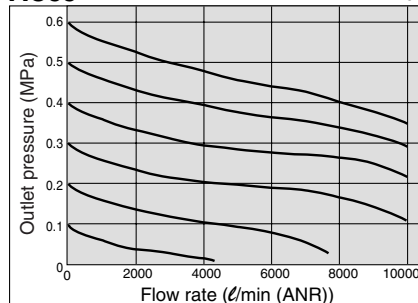

AC60 Rc1

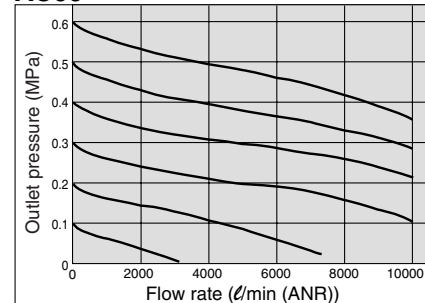

Pressure Characteristics (Representative values)

Conditions: Inlet pressure 0.7 MPa, Outlet pressure 0.2 MPa, Flow rate 20 ℓ/min (ANR)

AC10

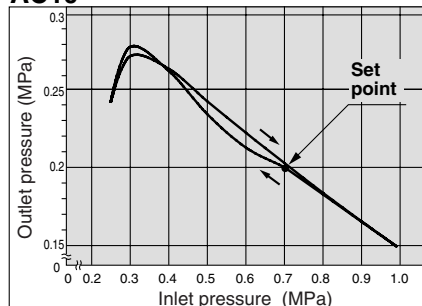

AC20

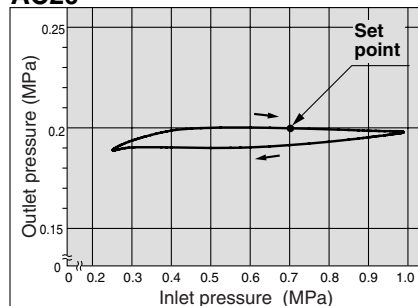

AC25

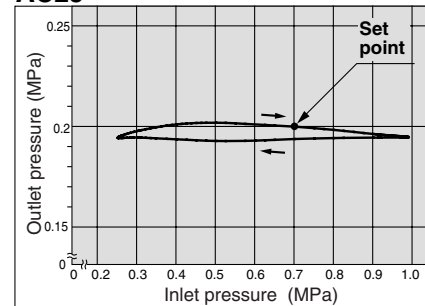

AC30

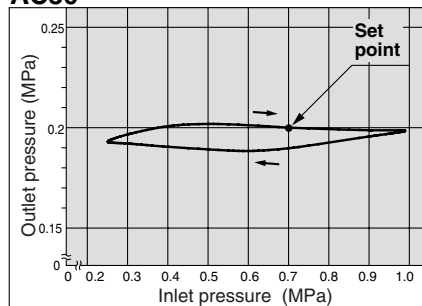

AC40

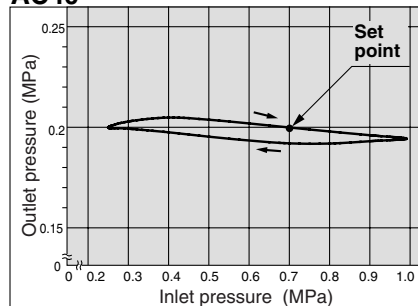

AC40-06

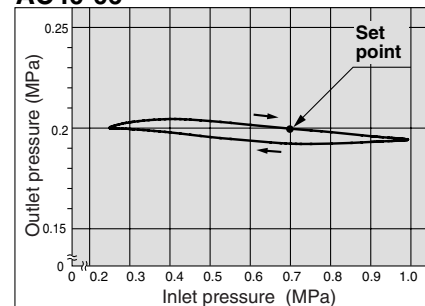

Pressure Characteristics (Representative values)

Conditions: Inlet pressure 0.7 MPa, Outlet pressure 0.2 MPa, Flow rate 20 ℓ/min (ANR)

AC50

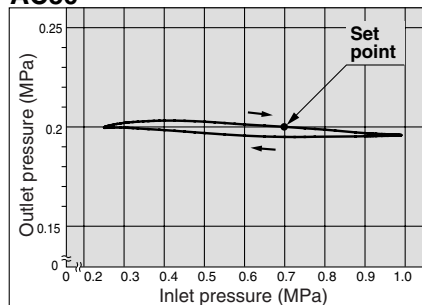

AC55

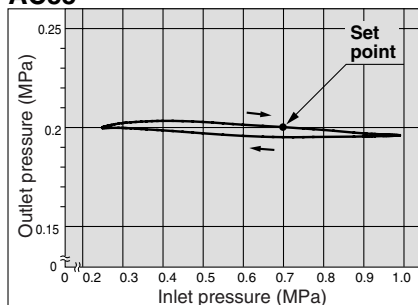

AC60

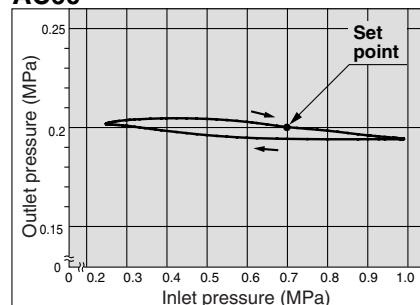

⚠ Specific Product Precautions

Be sure to read before handling.

Refer to front matters 42 and 43 for Safety Instructions and pages 287 to 291 for F.R.L. Precautions.

Mounting and Adjustment

⚠ Caution

1. A knob cover is available to prevent careless operation of the knob. Refer to page 389 for details.

Piping

⚠ Warning

1. When mounting a check valve, make sure the arrow (IN side) points in the correct direction of air flow.

Air Supply

⚠ Caution

1. Use an air filter with 5 μm or less filtration rating on the inlet side of the valve to avoid any damage to the seat caused by dust when mounting a 3-port valve for residual pressure release on the inlet side.

Selection

⚠ Warning

1. Float type auto drain

Operate under the following conditions to avoid malfunction.

<N.O. type>

- Operating compressor: 0.75 kW (100 ℓ/min (ANR)) or more.

When using 2 or more auto drains, multiply the value above by the number of auto drains to find the capacity of the compressors you will need.

For example, when using 2 auto drains, 1.5 kW (200 ℓ/min (ANR)) of the compressor capacity is required.

- Operating pressure: 0.1 MPa or more.

<N.C. type>

- Operating pressure for AD17/27: 0.1 MPa or more.

- Operating pressure for AD37/47: 0.15 MPa or more.

2. Use a regulator or filter regulator with backflow function when mounting a 3-port valve for residual pressure release on the IN side to ensure the release of the residual pressure. Otherwise, residual pressure will not be fully released.

⚠ Caution

1. When releasing air at the intermediate position using a T-interface on the inlet side of the lubricator, lubricant may back flow. Therefore, releasing air that does not contain traces of lubricant is not possible.

To release air that does not contain traces of lubricant, use a check valve (AKM series) on the inlet side of the lubricator to prevent a backflow of the lubricant.

2. If a residual pressure-release 3-port valve is mounted on the inlet side of the lubricator, causing a backflow of air, it can result in a backflow of oil or damage to internal parts. Please do not use it in this fashion.

3. An F.R.L. unit shipped from the plant has its model number labeled. However, components that are combined together during the distribution process do not have a label on them.

AC

AF □

AR

AL

AW □

A □ **G**

AV

AF800
AF900

Series AC10 to AC60

Dimensions

AC10, AC20

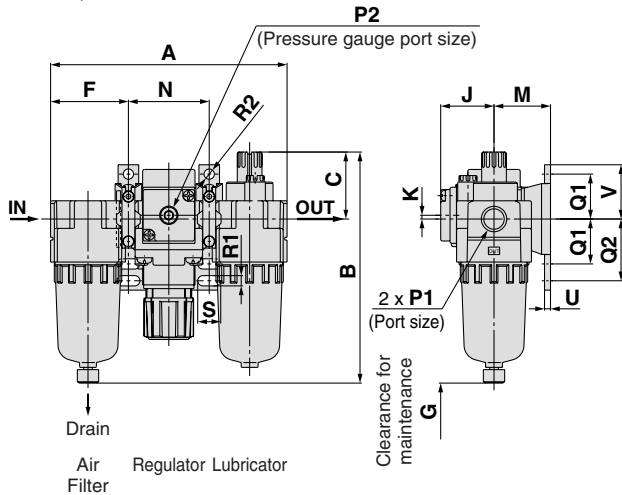

AC25 to AC60

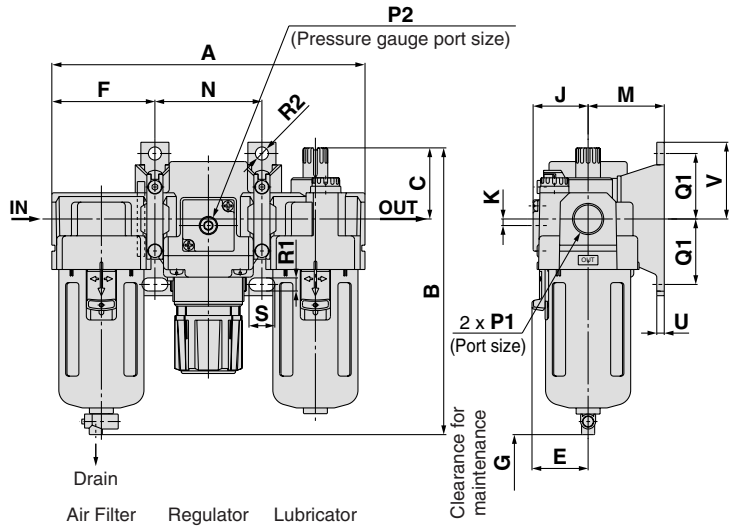

Applicable model	AC20 to AC60		AC10 to AC60	AC20 to AC60
Option	Square embedded type pressure gauge	Digital pressure switch	Round type pressure gauge	Round type pressure gauge (with color zone)
Dimensions	Center of piping	Center of piping	Center of piping	Center of piping

Applicable model	AC10, AC20		AC20	AC25 to AC60				
Optional/Semi-standard specifications	With auto drain (N.C.)	Metal bowl	With drain guide	With auto drain (N.O./N.C.)	Metal bowl	Metal bowl with level gauge	With drain guide	Drain cock with barb fitting
Dimensions	B M5 x 0.8	B	B 1/8 Width across flats 14	B N.O.: Black N.C.: Gray ø10 one-touch fitting	B	B	B 1/4 Width across flats 17	B Barb fitting Applicable tubing: T0604

Model	Standard specifications										Optional specifications							
	P1	P2	A	B	C	E	F	G	J	K	Square type pressure gauge	Digital pressure switch	Round type pressure gauge	Round type pressure gauge (with color zone)				
AC10	M5 x 0.8	1/16	87	85	26	—	28	35	13	0	—	—	—	—	ø26	26	—	—
AC20	1/8, 1/4	1/8	126	123	36	—	41.5	60	28.5	2 ^{Note)}	□28	29.5	□27.8	40	ø37.5	65	ø37.5	65
AC25	1/4, 3/8	1/8	167	153	38	30	55	80	27.5	0	□28	28.5	□27.8	39	ø37.5	64	ø37.5	64
AC30	1/4, 3/8	1/8	167	153	38	30	55	80	29.5	3.5	□28	30.5	□27.8	41	ø37.5	66	ø37.5	66
AC40	1/4, 3/8, 1/2	1/4	220	187	40	38	72.5	110	34	3.5	□28	35	□27.8	45	ø42.5	74	ø42.5	74
AC40-06	3/4	1/4	235	187	38	38	77.5	110	34	3	□28	35	□27.8	45	ø42.5	74	ø42.5	74
AC50	3/4, 1	1/4	282	264	43	45	93	110	43.5	3.3	□28	44.5	□27.8	55	ø42.5	84	ø42.5	84
AC55	1	1/4	292	279	45	47.5	98	110	43.5	3.3	□28	44.5	□27.8	55	ø42.5	84	ø42.5	84
AC60	1	1/4	297	280	46	47.5	98	110	43.5	3.3	□28	44.5	□27.8	55	ø42.5	84	ø42.5	84

Model	Optional specifications										Semi-standard specifications				
	Bracket mount										With auto drain	With barb fitting	With drain guide	Metal bowl	Metal bowl with level gauge
	M	N	Q1	Q2	R1	R2	S	U	V		B	B	B	B	B
AC10	25	31	20	27	4.5	ø4.5	7	2.8	24.5		104	—	—	85	—
AC20	30	43	24	33	5.5	ø5.5	12	3.2	29		141	—	127	123	—
AC25	41	57	35	—	7	ø7	14	4	41		194	161	160	166	186
AC30	41	57	35	—	7	ø7	14	4	41		194	161	160	166	186
AC40	50	75	40	—	9	ø9	18	4	48		226	195	194	200	220
AC40-06	50	80	40	—	9	ø9	18	4.6	48		226	195	194	200	220
AC50	70	96	50	—	11	ø11	20	6.4	60		303	272	271	276	296
AC55	70	96	50	—	11	ø11	20	6.4	60		318	287	286	292	312
AC60	70	101	50	—	11	ø11	20	6.4	60		319	288	287	293	313

Note) For the AC20 only, the position of the pressure gauge is above the center of the piping.

AC

AF□

AR

AL

AW□

A□G

AV

AF800
AF900

AC10A to AC60A

JIS Symbol

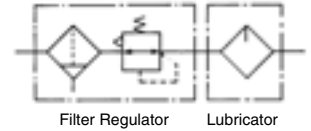

How to Order

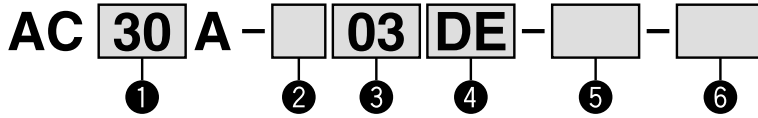

- Option/Semi-standard: Select one each for a to l.
- Option/Attachment/Semi-standard symbol: When more than one specification is required, indicate in alphanumeric order.
Example) AC30A-F03DE1-KSV-136NR

		Symbol	Description	①						
				Body size						
				10	20	30	40	50	60	
②	Thread type	Nil	Metric thread (M5)	●	—	—	—	—	—	
		N ^{Note 1)}	Rc	—	●	●	●	●	●	
		F ^{Note 2)}	NPT	—	●	●	●	●	●	
			G	—	●	●	●	●	●	
+										
③	Port size	M5	M5	●	—	—	—	—	—	
		01	1/8	—	●	—	—	—	—	
		02	1/4	—	●	●	—	—	—	
		03	3/8	—	—	●	●	—	—	
		04	1/2	—	—	—	●	—	—	
		06	3/4	—	—	—	—	●	—	
		10	1	—	—	—	—	●	●	
+										
④	a	Float type auto drain	Nil	Without auto drain	●	●	●	●	●	●
			C	Float type auto drain (N.C.)	●	●	●	●	●	●
			D	Float type auto drain (N.O.)	—	—	●	●	●	●
	+									
	b	Pressure gauge	Nil	Without pressure gauge	●	●	●	●	●	●
			E	Square embedded type pressure gauge (with limit indicator)	—	●	●	●	●	●
			G	Round type pressure gauge (without limit indicator)	●	—	—	—	—	—
				Round type pressure gauge (with limit indicator)	—	●	●	●	●	●
		Digital pressure switch	M	Round type pressure gauge (with color zone)	—	●	●	●	●	●
			E1	Output: NPN output / Electrical entry: Wiring bottom entry	—	●	●	●	●	●
	E2	Output: NPN output / Electrical entry: Wiring top entry	—	●	●	●	●	●		
	E3	Output: PNP output / Electrical entry: Wiring bottom entry	—	●	●	●	●	●		
E4	Output: PNP output / Electrical entry: Wiring top entry	—	●	●	●	●	●			
+										
⑤	c	Check valve	Nil	Without attachment	●	●	●	●	●	
			K	Mounting position: AW+K+AL	—	●	●	● ^{Note 4)}	—	—
	+									
	d	Pressure switch	Nil	Without attachment	●	●	●	●	●	●
			S ^{Note 5)}	Mounting position: AW+S+AL	—	●	●	●	●	●
+										
e	3-port valve for residual pressure release	Nil	Without attachment	●	●	●	●	●	●	
		V	Mounting position: AW+AL+V	—	●	●	●	●	—	
+										
⑥	f	Set pressure	Nil	0.05 to 0.85 MPa setting	●	●	●	●	●	●
			1 ^{Note 6)}	0.02 to 0.2 MPa setting	●	●	●	●	●	●
	+									
	g	Bowl ^{Note 7)}	Nil	Polycarbonate bowl	●	●	●	●	●	●
			2	Metal bowl	●	●	●	●	●	●
			6	Nylon bowl	●	●	●	●	●	●
			8	Metal bowl with level gauge	—	—	●	●	●	●
			C	With bowl guard	—	●	—	—	—	—
			6C	Nylon bowl with bowl guard	—	●	—	—	—	—
	+									
	h	Filter regulator drain port ^{Note 8)}	Nil	With drain cock	●	●	●	●	●	●
			J ^{Note 9)}	Drain guide 1/8	—	●	—	—	—	—
Drain guide 1/4				—	—	●	●	●	●	
W ^{Note 10)}			Drain cock with barb fitting: For ø6 x ø4 nylon tube	—	—	●	●	●	●	

Air Combination Series AC10A to AC60A

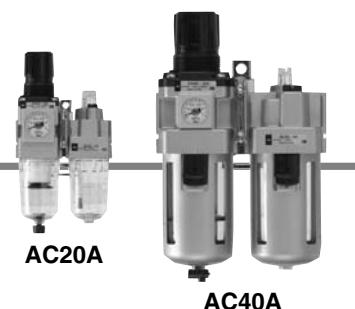

		Symbol	Description	①						
				Body size						
				10	20	30	40	50	60	
⑥	i	Lubricator lubricant exhaust port	Nil	Without drain cock	●	●	●	●	●	●
			3	Lubricator with drain cock	●	●	●	●	●	●
				+						
	j	Exhaust mechanism	Nil	Relieving type	●	●	●	●	●	●
			N	Non-relieving type	●	●	●	●	●	●
			+							
	k	Flow direction	Nil	Flow direction: Left to right	●	●	●	●	●	●
			R	Flow direction: Right to left	●	●	●	●	●	●
			+							
	l	Pressure unit	Nil	Name plate and pressure gauge in imperial units: MPa	●	●	●	●	●	●
			Z ^{Note 11)}	Name plate, caution plate for bowl, and pressure gauge in imperial units: psi, °F	○ ^{Note 13)}	○ ^{Note 13)}	○ ^{Note 13)}	○ ^{Note 13)}	○ ^{Note 13)}	○ ^{Note 13)}
			ZA ^{Note 12)}	Digital pressure switch: With unit conversion function	—	△ ^{Note 14)}	△ ^{Note 14)}	△ ^{Note 14)}	△ ^{Note 14)}	△ ^{Note 14)}

Note 1) Drain guide is NPT1/8 (applicable to the AC20A) and NPT1/4 (applicable to the AC30A to AC60A). The auto drain port comes with ø3/8" one-touch fitting (applicable to the AC30A to AC60A).

Note 2) Drain guide is G1/8 (applicable to the AC20A) and G1/4 (applicable to the AC30A to AC60A).

Note 3) Option G, M are not assembled and supplied loose at the time of shipment.

Note 4) Not available with piping port size: 06.

Note 5) The bracket position varies depending on the pressure switch mounting.

Note 6) The only difference from the standard specifications is the adjusting spring for the regulator. It does not restrict the setting of 0.2 MPa or more. When the pressure gauge is attached, a 0.2 MPa pressure gauge will be fitted.

Note 7) Refer to Chemical Data on page 287 when selecting a case material.

Note 8) Float type auto drain: The combination of C and D is not possible.

Note 9) Without a valve function

Note 10) Metal bowl: The combination of 2 and 8 is not possible.

Note 11) For thread type: M5 and NPT. This product is for overseas use only according to the new Measurement Law. (The SI unit type is provided for use in Japan.) The digital pressure switch will be equipped with the unit conversion function, setting to psi initially.

MPa and psi are shown together on the pressure unit. The combination of the round type pressure gauge with color zone "M" and a psi display "Z" is not orderable as a standard product. However, this combination is available as a special.

Note 12) For options: E1, E2, E3, E4. This product is for overseas use only according to the new Measurement Law. (The SI unit is provided for use in Japan.)

Note 13) ○: For thread type: M5 and NPT only

Note 14) △: Select with options: E1, E2, E3, E4.

Standard Specifications

Model		AC10A	AC20A	AC30A	AC40A	AC40A-06	AC50A	AC60A
Component	Filter regulator	AW10	AW20	AW30	AW40	AW40-06	AW60	AW60
	Lubricator	AL10	AL20	AL30	AL40	AL40-06	AL50	AL60
Port size		M5 x 0.8	1/8, 1/4	1/4, 3/8	1/4, 3/8, 1/2	3/4	3/4, 1	1
Pressure gauge port size ^{Note 1)}		1/16	1/8		1/4			
Fluid		Air						
Ambient and fluid temperature ^{Note 2)}		-5 to 60°C (with no freezing)						
Proof pressure		1.5 MPa						
Maximum operating pressure		1.0 MPa						
Set pressure range		0.05 to 0.7 MPa	0.05 to 0.85 MPa					
Relief pressure		Set pressure + 0.05 MPa ^{Note 3)} [at relief flow rate of 0.1 ℓ/min (ANR)]						
Nominal filtration rating		5 μm						
Recommended lubricant		Class 1 turbine oil (ISO VG32)						
Bowl material		Polycarbonate						
Bowl guard		—	Semi-standard	Standard				
Regulator construction		Relieving type						
Mass (kg)		0.20	0.38	0.75	1.41	1.46	3.33	3.40

Note 1) Pressure gauge connection threads are not available for F.R.L. unit with a square embedded type pressure gauge or with a digital pressure switch (AC20A to AC60A).

Note 2) -5 to 50°C for the products with the digital pressure switch

Note 3) Not applicable to the AC10A.

AC

AF□

AR

AL

AW□

A□G

AV

AF800
AF900

Series AC10A to AC60A

Dimensions

AC10A, AC20A

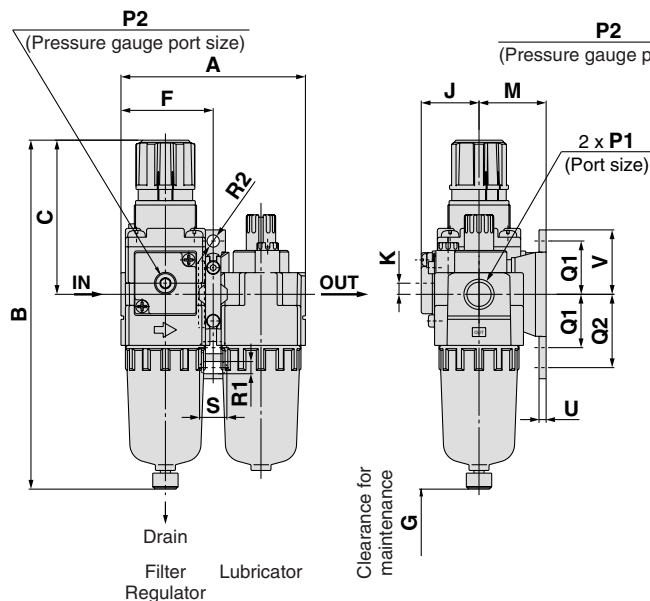

AC30A to AC60A

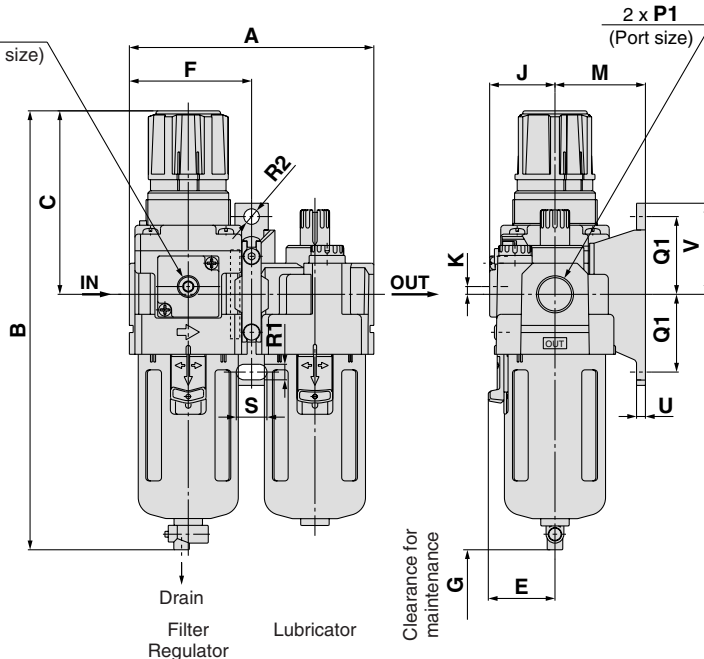

Applicable model	AC20A to AC60A		AC10A to AC60A	AC20A to AC60A
Option	Square embedded type pressure gauge	Digital pressure switch	Round type pressure gauge	Round type pressure gauge (with color zone)
Dimensions				

Applicable model	AC10A, AC20A		AC20A	AC30A to AC60A				
Optional/Semi-standard specifications	With auto drain (N.C.)	Metal bowl	With drain guide	With auto drain (N.O./N.C.)	Metal bowl	Metal bowl with level gauge	With drain guide	Drain cock with barb fitting
Dimensions								

Model	Standard specifications										Optional specifications							
	P1	P2	A	B (Note)	C	E	F	G	J	K	Square type pressure gauge H	J	Digital pressure switch H	J	Round type pressure gauge H	J	Round type pressure gauge (with color zone) H	J
AC10A	M5 x 0.8	1/16	56	108	48	—	28	35	13	0	—	—	—	—	ø26	26	—	—
AC20A	1/8, 1/4	1/8	83	160	73	—	41.5	60	26	5	□28	27	□27.8	37.5	ø37.5	63	ø37.5	63
AC30A	1/4, 3/8	1/8	110	201	86	30	55	80	29.5	3.5	□28	30.5	□27.8	41	ø37.5	66	ø37.5	66
AC40A	1/4, 3/8, 1/2	1/4	145	239	92	38	72.5	110	37.5	1.5	□28	38.5	□27.8	49	ø42.5	76	ø42.5	76
AC40A-06	3/4	1/4	155	242	93	38	77.5	110	37.5	1.2	□28	38.5	□27.8	49	ø42.5	76	ø42.5	76
AC50A	3/4, 1	1/4	191	409	175	—	98	110	43.5	3.2	□28	44.5	□27.8	61.5	ø42.5	84	ø42.5	84
AC60A	1	1/4	196	409	175	—	98	110	43.5	3.2	□28	44.5	□27.8	61.5	ø42.5	84	ø42.5	84

Model	Optional specifications									Semi-standard specifications				
	Bracket mount									With auto drain	With barb fitting	With drain guide	Metal bowl	Metal bowl with level gauge
	M	Q1	Q2	R1	R2	S	U	V		B	B	B	B	B
AC10A	25	20	27	4.5	ø4.5	7	2.8	24.5		125	—	—	107	—
AC20A	30	24	33	5.5	ø5.5	12	3.2	29		177	—	164	160	—
AC30A	41	35	—	7	ø7	14	4	41		242	209	208	214	234
AC40A	50	40	—	9	ø9	18	4	48		278	247	246	252	272
AC40A-06	50	40	—	9	ø9	18	4.6	48		282	251	249	255	275
AC50A	70	50	—	11	ø11	20	6.4	60		448	417	416	422	442
AC60A	70	50	—	11	ø11	20	6.4	60		448	417	416	422	442

Note) The total length of B dimension is the length when the filter regulator knob is unlocked.

AC

AF□

AR

AL

AW□

A□G

AV

AF800
AF900

AC10B to AC60B

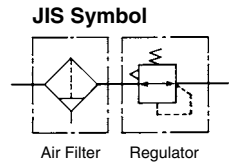

How to Order

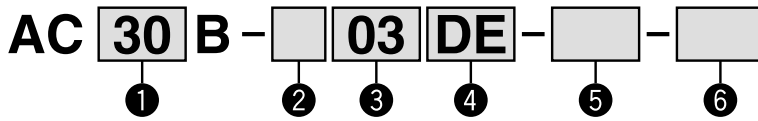

- Option/Semi-standard: Select one each for a to j.
- Option/Attachment/Semi-standard symbol: When more than one specification is required, indicate in alphanumeric order.
Example) AC30B-F03DE1-SV-16NR

		Symbol	Description	①								
				Body size								
				10	20	25	30	40	50	55	60	
②	Thread type	Nil	Metric thread (M5)	●	—	—	—	—	—	—	—	
		N ^{Note 1)}	Rc	—	●	●	●	●	●	●	●	
		F ^{Note 2)}	NPT	—	●	●	●	●	●	●	●	
			G	—	●	●	●	●	●	●	●	
+												
③	Port size	M5	M5	●	—	—	—	—	—	—	—	
		01	1/8	—	●	—	—	—	—	—	—	
		02	1/4	—	●	●	●	—	—	—	—	
		03	3/8	—	—	●	●	●	—	—	—	
		04	1/2	—	—	—	—	●	—	—	—	
		06	3/4	—	—	—	—	●	●	—	—	
		10	1	—	—	—	—	—	●	●	●	
+												
④	a	Float type auto drain	Nil	Without auto drain	●	●	●	●	●	●	●	
			C	Float type auto drain (N.C.)	●	●	●	●	●	●	●	
			D	Float type auto drain (N.O.)	—	—	●	●	●	●	●	
	+											
	b	Pressure gauge	Nil	Without pressure gauge	●	●	●	●	●	●	●	
			E	Square embedded type pressure gauge (with limit indicator)	—	●	●	●	●	●	●	
			G	Round type pressure gauge (without limit indicator)	●	—	—	—	—	—	—	
			M	Round type pressure gauge (with color zone)	—	●	●	●	●	●	●	
		Digital pressure switch	E1	Output: NPN output / Electrical entry: Wiring bottom entry	—	●	●	●	●	●	●	
			E2	Output: NPN output / Electrical entry: Wiring top entry	—	●	●	●	●	●	●	
	+											
	⑤	c	Pressure switch	Nil	Without attachment	●	●	●	●	●	●	●
S ^{Note 4)}				Mounting position: AF+S+AR	—	●	●	●	●	●	●	
T ^{Note 4)}				Mounting position: AF+T+AR	●	●	●	●	●	●	●	
+												
⑤	d	3-port valve for residual pressure release	Nil	Without attachment	●	●	●	●	●	●	●	
			V	Mounting position: AF+AR+V	—	●	●	●	●	●	—	
			V1 ^{Note 5)}	Mounting position: V+AF+AR□K	—	●	●	●	●	●	—	
+												
⑥	e	Set pressure	Nil	0.05 to 0.85 MPa setting	●	●	●	●	●	●	●	
			1 ^{Note 6)}	0.02 to 0.2 MPa setting	●	●	●	●	●	●	●	
	+											
	f	Bowl ^{Note 7)}	Nil	Polycarbonate bowl	●	●	●	●	●	●	●	
			2	Metal bowl	●	●	●	●	●	●	●	
			6	Nylon bowl	●	●	●	●	●	●	●	
			8	Metal bowl with level gauge	—	—	●	●	●	●	●	
			C	With bowl guard	—	●	—	—	—	—	—	
	6C	Nylon bowl with bowl guard	—	●	—	—	—	—	—			
	+											
g	Filter drain port ^{Note 8)}	Nil	With drain cock	●	●	●	●	●	●	●		
		J ^{Note 9)}	Drain guide 1/8	—	●	—	—	—	—	—		
		W ^{Note 10)}	Drain guide 1/4	—	—	●	●	●	●	●		
			Drain cock with barb fitting: For ø6 x ø4 nylon tube	—	—	●	●	●	●	●		

Air Combination Series AC10B to AC60B

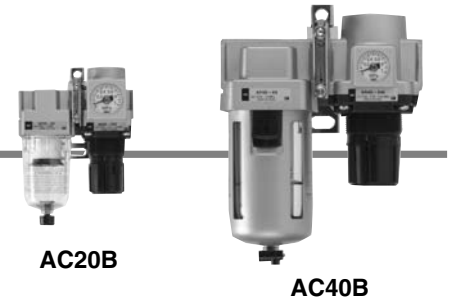

		Symbol	Description	①									
				Body size									
				10	20	25	30	40	50	55	60		
⑥	h	Exhaust mechanism	Nil	Relieving type	●	●	●	●	●	●	●	●	
			N	Non-relieving type	●	●	●	●	●	●	●	●	
				+									
	i	Flow direction	Nil	Flow direction: Left to right	●	●	●	●	●	●	●	●	
			R	Flow direction: Right to left	●	●	●	●	●	●	●	●	
					+								
j	Pressure unit	Nil	Name plate and pressure gauge in imperial units: MPa	●	●	●	●	●	●	●	●		
		Z ^{Note 11)}	Name plate, caution plate for bowl, and pressure gauge in imperial units: psi, °F	○ ^{Note 13)}	○ ^{Note 13)}	○ ^{Note 13)}	○ ^{Note 13)}	○ ^{Note 13)}	○ ^{Note 13)}	○ ^{Note 13)}	○ ^{Note 13)}		
		ZA ^{Note 12)}	Digital pressure switch: With unit conversion function	—	△ ^{Note 14)}	△ ^{Note 14)}	△ ^{Note 14)}	△ ^{Note 14)}	△ ^{Note 14)}	△ ^{Note 14)}	△ ^{Note 14)}	△ ^{Note 14)}	

Note 1) Drain guide is NPT1/8 (applicable to the AC20B) and NPT1/4 (applicable to the AC25B to AC60B). The auto drain port comes with ø3/8" one-touch fitting (applicable to the AC25B to AC60B).
 Note 2) Drain guide is G1/8 (applicable to the AC20B) and G1/4 (applicable to the AC25B to AC60B).
 Note 3) Option G, M are not assembled and supplied loose at the time of shipment.
 Note 4) The bracket position varies depending on the T-interface or pressure switch mounting.

Note 5) The regulator is equipped with a backflow function in this configuration. Additionally, for safety purposes, please check that the pressure in the outlet side is turned to the atmospheric pressure once the pressure in the outlet side is exhausted, by using a pressure gauge, etc.
 Note 6) The only difference from the standard specifications is the adjusting spring for the regulator. It does not restrict the setting of 0.2 MPa or more. When the pressure gauge is attached, a 0.2 MPa pressure gauge will be fitted.
 Note 7) Refer to Chemical Data on page 287 when selecting a case material.
 Note 8) Float type auto drain: The combination of C and D is not possible.
 Note 9) Without a valve function

Note 10) Metal bowl: The combination of 2 and 8 is not possible.
 Note 11) For thread type: M5 and NPT. This product is for overseas use only according to the new Measurement Law. (The SI unit type is provided for use in Japan.) The digital pressure switch will be equipped with the unit conversion function, setting to psi initially. MPa and psi are shown together on the pressure unit. The combination of the round type pressure gauge with color zone "M" and a psi display "Z" is not orderable as a standard product. However, this combination is available as a special.
 Note 12) For options: E1, E2, E3, E4. This product is for overseas use only according to the new Measurement Law. (The SI unit is provided for use in Japan.)
 Note 13) ○: For thread type: M5 and NPT only
 Note 14) △: Select with options: E1, E2, E3, E4.

Standard Specifications

Model		AC10B	AC20B	AC25B	AC30B	AC40B	AC40B-06	AC50B	AC55B	AC60B	
Component	Air filter	AF10	AF20	AF30	AF30	AF40	AF40-06	AF50	AF60	AF60	
	Regulator	AR10	AR20	AR25	AR30	AR40	AR40-06	AR50	AR50	AR60	
Port size		M5 x 0.8	1/8, 1/4	1/4, 3/8	1/4, 3/8	1/4, 3/8, 1/2	3/4	3/4, 1	1	1	
Pressure gauge port size ^{Note 1)}		1/16	1/8			1/4					
Fluid		Air									
Ambient and fluid temperature ^{Note 2)}		-5 to 60°C (with no freezing)									
Proof pressure		1.5 MPa									
Maximum operating pressure		1.0 MPa									
Set pressure range		0.05 to 0.7 MPa	0.05 to 0.85 MPa								
Relief pressure		Set pressure + 0.05 MPa ^{Note 3)} [at relief flow rate of 0.1 ℓ/min (ANR)]									
Nominal filtration rating		5 μm									
Bowl material		Polycarbonate									
Bowl guard		—	Semi-standard	Standard							
Regulator construction		Relieving type									
Mass (kg)		0.16	0.33	0.55	0.63	1.12	1.16	2.44	2.45	2.54	

Note 1) Pressure gauge connection threads are not available for F.R.L. unit with a square embedded type pressure gauge or with a digital pressure switch (AC10B to AC60B).
 Note 2) -5 to 50°C for the products with the digital pressure switch
 Note 3) Not applicable to the AC10B.

AC
 AF□
 AR
 AL
 AW□
 A□G
 AV
 AF800
 AF900

Series AC10B to AC60B

Dimensions

AC10B, AC20B

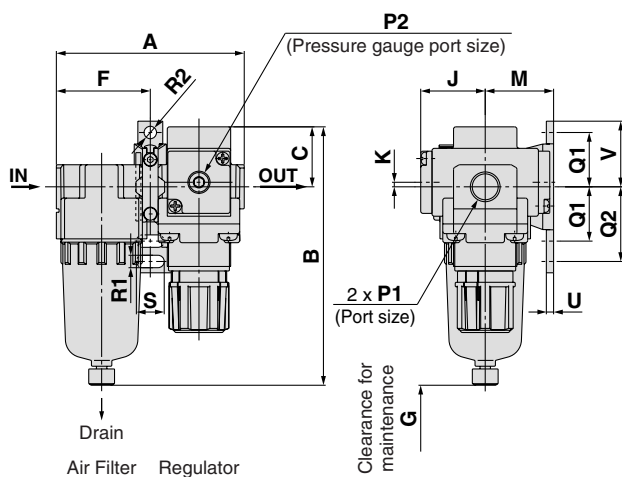

AC25B to AC60B

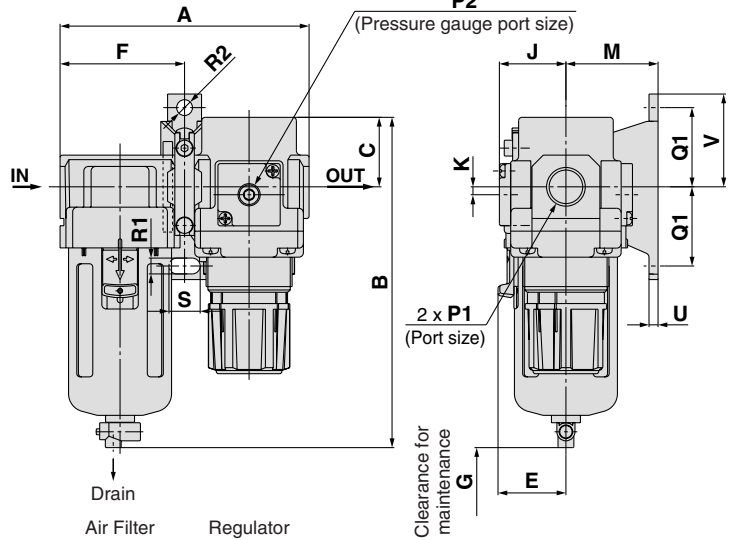

Applicable model	AC20B to AC60B		AC10B to AC60B	AC20B to AC60B
Option	Square embedded type pressure gauge	Digital pressure switch	Round type pressure gauge	Round type pressure gauge (with color zone)
Dimensions				

Applicable model	AC10B, AC20B		AC20B	AC25B to AC60B				
Optional/Semi-standard specifications	With auto drain (N.C.)	Metal bowl	With drain guide	With auto drain (N.O./N.C.)	Metal bowl	Metal bowl with level gauge	With drain guide	Drain cock with barb fitting
Dimensions								

Model	Standard specifications										Optional specifications							
	P1	P2	A	B	C	E	F	G	J	K	Square type pressure gauge	Digital pressure switch	Round type pressure gauge	Round type pressure gauge (with color zone)				
AC10B	M5 x 0.8	1/16	56	71	11	—	28	25	13	0	—	—	—	—	ø26	26	—	—
AC20B	1/8, 1/4	1/8	83	114	26.5	—	41.5	40	28.5	2 (Note)	□28	29.5	□27.8	40	ø37.5	65	ø37.5	65
AC25B	1/4, 3/8	1/8	110	143	28	30	55	50	27.5	0	□28	28.5	□27.8	39	ø37.5	64	ø37.5	64
AC30B	1/4, 3/8	1/8	110	146	31	30	55	50	29.5	3.5	□28	30.5	□27.8	41	ø37.5	66	ø37.5	66
AC40B	1/4, 3/8, 1/2	1/4	145	183	36	38	72.5	75	34	3.5	□28	35	□27.8	45	ø42.5	74	ø42.5	74
AC40B-06	3/4	1/4	155	185	36	38	77.5	75	34	3	□28	35	□27.8	45	ø42.5	74	ø42.5	74
AC50B	3/4, 1	1/4	186	263	43	45	93	20	43.5	3.3	□28	44.5	□27.8	55	ø42.5	84	ø42.5	84
AC55B	1	1/4	191	277	43	47.5	98	20	43.5	3.3	□28	44.5	□27.8	55	ø42.5	84	ø42.5	84
AC60B	1	1/4	196	280	46	47.5	98	20	43.5	3.3	□28	44.5	□27.8	55	ø42.5	84	ø42.5	84

Model	Optional specifications									Semi-standard specifications				
	Bracket mount									With auto drain	With barb fitting	With drain guide	Metal bowl	Metal bowl with level gauge
	M	Q1	Q2	R1	R2	S	U	V	B	B	B	B	B	
AC10B	25	20	27	4.5	ø4.5	7	2.8	24.5	89	—	—	—	—	
AC20B	30	24	33	5.5	ø5.5	12	3.2	29	132	—	—	118	114	
AC25B	41	35	—	7	ø7	14	4	41	184	151	150	156	176	
AC30B	41	35	—	7	ø7	14	4	41	187	154	153	159	179	
AC40B	50	40	—	9	ø9	18	4	48	222	191	190	196	216	
AC40B-06	50	40	—	9	ø9	18	4.6	48	224	193	192	198	218	
AC50B	70	50	—	11	ø11	20	6.4	60	303	271	270	277	297	
AC55B	70	50	—	11	ø11	20	6.4	60	316	285	284	290	310	
AC60B	70	50	—	11	ø11	20	6.4	60	319	288	287	293	313	

Note) For the AC20B only, the position of the pressure gauge is above the center of the piping.

AC

AF□

AR

AL

AW□

A□G

AV

**AF800
AF900**

AC20C to AC40C

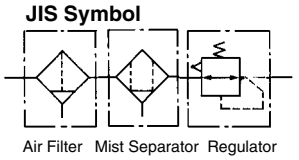

How to Order

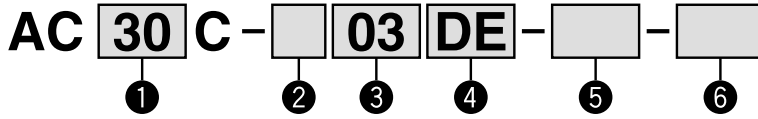

- Option/Semi-standard: Select one each for a to j.
- Option/Attachment/Semi-standard symbol: When more than one specification is required, indicate in alphanumeric order.
Example) AC30C-F03DE1-SV-16NR

	Symbol	Description	① Body size					
			20	25	30	40		
② Thread type	Nil	Rc	●	●	●	●		
	N ^{Note 1)}	NPT	●	●	●	●		
	F ^{Note 2)}	G	●	●	●	●		
+								
③ Port size	01	1/8	●	—	—	—		
	02	1/4	●	●	●	●		
	03	3/8	—	●	●	●		
	04	1/2	—	—	—	●		
	06	3/4	—	—	—	●		
+								
④ Option	a Float type auto drain	Nil	Without auto drain	●	●	●	●	
		C	Float type auto drain (N.C.)	●	●	●	●	
		D	Float type auto drain (N.O.)	—	●	●	●	
	+							
	b	Pressure gauge	Nil	Without pressure gauge	●	●	●	●
			E	Square embedded type pressure gauge (with limit indicator)	●	●	●	●
			G	Round type pressure gauge (with limit indicator)	●	●	●	●
			M	Round type pressure gauge (with color zone)	●	●	●	●
		Digital pressure switch	E1	Output: NPN output / Electrical entry: Wiring bottom entry	●	●	●	●
			E2	Output: NPN output / Electrical entry: Wiring top entry	●	●	●	●
E3			Output: PNP output / Electrical entry: Wiring bottom entry	●	●	●	●	
E4	Output: PNP output / Electrical entry: Wiring top entry	●	●	●	●			
+								
⑤ Attachment	c Pressure switch	Nil	Without attachment	●	●	●	●	
		S ^{Note 4)}	Mounting position: AF+AFM+S+AR	●	●	●	●	
	T-interface	T ^{Note 4)}	Mounting position: AF+AFM+T+AR	●	●	●	●	
+								
d 3-port valve for residual pressure release	Nil	Without attachment	●	●	●	●		
	V	Mounting position: AF+AFM+AR+V	●	●	●	●		
	V1 ^{Note 5)}	Mounting position: V+AF+AFM+AR□K	●	●	●	●		
+								
e Set pressure	Nil	0.05 to 0.85 MPa setting	●	●	●	●		
	1 ^{Note 6)}	0.02 to 0.2 MPa setting	●	●	●	●		
+								
⑥ Semi-standard	f Bowl ^{Note 7)}	Nil	Polycarbonate bowl	●	●	●	●	
		2	Metal bowl	●	●	●	●	
		6	Nylon bowl	●	●	●	●	
		8	Metal bowl with level gauge	—	●	●	●	
		C	With bowl guard	●	—	—	—	
		6C	Nylon bowl with bowl guard	●	—	—	—	
+								
g Filter Mist separator drain port ^{Note 8)}	Nil	With drain cock	●	●	●	●		
		J ^{Note 9)}	Drain guide 1/8	●	—	—	—	
	W ^{Note 10)}	Drain guide 1/4	—	●	●	●		
		Drain cock with barb fitting: For ø6 x ø4 nylon tube	—	●	●	●		
+								
h Exhaust mechanism	Nil	Relieving type	●	●	●	●		
	N	Non-relieving type	●	●	●	●		

Air Combination Series AC20C to AC40C



		Symbol	Description	① Body size			
				20	25	30	40
⑥ Semi-standard	i	Flow direction	Nil	Flow direction: Left to right			
			R	Flow direction: Right to left			
				+			
	j	Pressure unit	Nil	Name plate and pressure gauge in imperial units: MPa			
Z ^{Note 11)}			Name plate, caution plate for bowl, and pressure gauge in imperial units: psi, °F				
ZA ^{Note 12)}			Digital pressure switch: With unit conversion function				
			●	●	●	●	
			●	●	●	●	
			○ ^{Note 13)}	○ ^{Note 13)}	○ ^{Note 13)}	○ ^{Note 13)}	
			△ ^{Note 14)}	△ ^{Note 14)}	△ ^{Note 14)}	△ ^{Note 14)}	

Note 1) Drain guide is NPT1/8 (applicable to the AC20C) and NPT1/4 (applicable to the AC30C to AC40C). The auto drain port comes with ø3/8" one-touch fitting (applicable to the AC30C to AC40C).
 Note 2) Drain guide is G1/8 (applicable to the AC20C) and G1/4 (applicable to the AC30C to AC40C).
 Note 3) Option G, M are not assembled and supplied loose at the time of shipment.
 Note 4) The bracket position varies depending on the T-interface or pressure switch mounting.

Note 5) The regulator is equipped with a backflow function in this configuration. Additionally, for safety purposes, please check that the pressure in the outlet side is turned to the atmospheric pressure once the pressure in the outlet side is exhausted, by using a pressure gauge, etc.
 Note 6) The only difference from the standard specifications is the adjusting spring for the regulator. It does not restrict the setting of 0.2 MPa or more. When the pressure gauge is attached, a 0.2 MPa pressure gauge will be fitted.
 Note 7) Refer to Chemical Data on page 287 when selecting a case material.
 Note 8) Float type auto drain: The combination of C and D is not possible.
 Note 9) Without a valve function

Note 10) Metal bowl: The combination of 2 and 8 is not possible.
 Note 11) For thread type: NPT. This product is for overseas use only according to the new Measurement Law. (The SI unit type is provided for use in Japan.) The digital pressure switch will be equipped with the unit conversion function, setting to psi initially. MPa and psi are shown together on the pressure unit. The combination of the round type pressure gauge with color zone "M" and a psi display "Z" is not orderable as a standard product. However, this combination is available as a special.
 Note 12) For options: E1, E2, E3, E4. This product is for overseas use only according to the new Measurement Law. (The SI unit is provided for use in Japan.)
 Note 13) ○: For thread type: NPT only
 Note 14) △: Select with options: E1, E2, E3, E4.

Standard Specifications

Model		AC20C	AC25C	AC30C	AC40C	AC40C-06
Component	Air filter	AF20	AF30	AF30	AF40	AF40-06
	Mist separator	AFM20	AFM30	AFM30	AFM40	AFM40-06
	Regulator	AR20	AR25	AR30	AR40	AR40-06
Port size		1/8, 1/4	1/4, 3/8	1/4, 3/8	1/4, 3/8, 1/2	3/4
Pressure gauge port size ^{Note 1)}		1/8			1/4	
Fluid		Air				
Ambient and fluid temperature ^{Note 2)}		-5 to 60°C (with no freezing)				
Proof pressure		1.5 MPa				
Maximum operating pressure		1.0 MPa				
Minimum operating pressure		0.05 MPa				
Set pressure range		0.05 to 0.85 MPa				
Relief pressure		Set pressure + 0.05 MPa [at relief flow rate of 0.1 ℓ/min (ANR)]				
Nominal filtration rating		AF: 5 μm, AFM: 0.3 μm (99.9% filtered particle size)				
Outlet side oil mist concentration		Max. 1.0 mg/m ³ (ANR) (≈ 0.8 ppm) ^{Note 4) Note 5)}				
Rated flow (ℓ/min (ANR)) ^{Note 3)}		200	450	450	1100	1100
Bowl material		Polycarbonate				
Bowl guard		Semi-standard	Standard			
Regulator construction		Relieving type				
Mass (kg)		0.48	0.88	0.95	1.76	1.83

Note 1) Pressure gauge connection threads are not available for F.R.L. unit with a square embedded type pressure gauge or with a digital pressure switch (AC20C to AC40C).
 Note 2) -5 to 50°C for the products with the digital pressure switch.
 Note 3) Conditions: Mist separator inlet pressure: 0.7 MPa; The rated flow varies depending on the inlet pressure. Keep the air flow within the rated flow to prevent an outflow of lubricant to the outlet side.
 Note 4) When the compressor oil mist discharge concentration is 30 mg/m³ (ANR).
 Note 5) Bowl O-ring and other O-rings are slightly lubricated.

AC
 AF□
 AR
 AL
 AW□
 A□G
 AV
 AF800
 AF900

Series AC20C to AC40C

Dimensions

AC20C

AC25C to AC40C-06

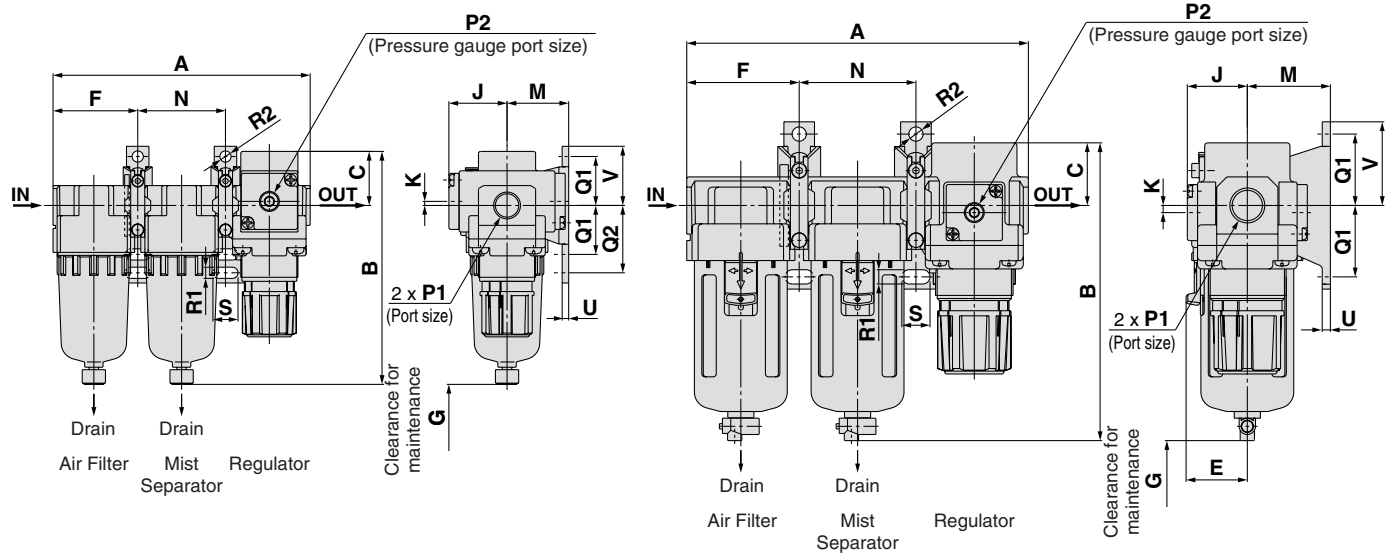

Applicable model	AC20C to AC40C-06			
Option	Square embedded type pressure gauge	Digital pressure switch	Round type pressure gauge	Round type pressure gauge (with color zone)
Dimensions				

Applicable model	AC20C				AC25C to AC40C-06			
Optional/Semi-standard specifications	With auto drain (N.C.)	Metal bowl	With drain guide	With auto drain (N.O./N.C.)	Metal bowl	Metal bowl with level gauge	With drain guide	Drain cock with barb fitting
Dimensions								

Model	Standard specifications										Optional specifications							
	P1	P2	A	B	C	E	F	G	J	K	H	J	H	J	H	J	H	J
AC20C	1/8, 1/4	1/8	126	114	26.5	—	41.5	45	28.5	2 (Note)	□28	29.5	□27.8	40	ø37.5	65	ø37.5	65
AC25C	1/4, 3/8	1/8	167	143	28	30	55	50	27.5	0	□28	28.5	□27.8	39	ø37.5	64	ø37.5	64
AC30C	1/4, 3/8	1/8	167	146	31	30	55	50	29.5	3.5	□28	30.5	□27.8	41	ø37.5	66	ø37.5	66
AC40C	1/4, 3/8, 1/2	1/4	220	183	36	38	72.5	75	34	3.5	□28	35	□27.8	45	ø42.5	74	ø42.5	74
AC40C-06	3/4	1/4	235	185	36	38	77.5	75	34	3	□28	35	□27.8	45	ø42.5	74	ø42.5	74

Model	Optional specifications										Semi-standard specifications				
	Bracket mount										With auto drain	With barb fitting	With drain guide	Metal bowl	Metal bowl with level gauge
	M	N	Q1	Q2	R1	R2	S	U	V		B	B	B	B	B
AC20C	30	43	24	33	5.5	ø5.5	12	3.2	29		132	—	118	114	—
AC25C	41	57	35	—	7	ø7	14	4	41		184	151	150	156	176
AC30C	41	57	35	—	7	ø7	14	4	41		187	154	153	159	179
AC40C	50	75	40	—	9	ø9	18	4	48		222	191	190	196	216
AC40C-06	50	80	40	—	9	ø9	18	4.6	48		224	193	192	198	218

Note) For the AC20C only, the position of the pressure gauge is above the center of the piping.

AC

AF□

AR

AL

AW□

A□G

AV

AF800
AF900

Filter Regulator + Mist Separator

AC20D to AC40D

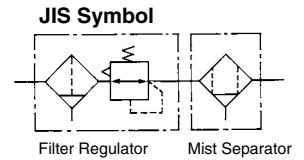

How to Order

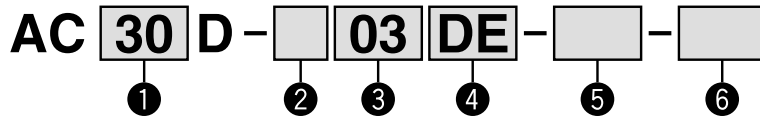

- Option/Semi-standard: Select one each for a to j.
- Option/Attachment/Semi-standard symbol: When more than one specification is required, indicate in alphanumeric order.
Example) AC30D-F03DE1-SV-16NR

		Symbol	Description	① Body size			
				20	30	40	
②	Thread type	Nil	Rc	●	●	●	
		N ^{Note 1)}	NPT	●	●	●	
		F ^{Note 2)}	G	●	●	●	
+							
③	Port size	01	1/8	●	—	—	
		02	1/4	●	●	●	
		03	3/8	—	●	●	
		04	1/2	—	—	●	
		06	3/4	—	—	●	
+							
④ Option	a	Float type auto drain	Nil	Without auto drain	●	●	●
			C	Float type auto drain (N.C.)	●	●	●
			D	Float type auto drain (N.O.)	—	●	●
	+						
	b	Pressure gauge	Nil	Without pressure gauge	●	●	●
			E	Square embedded type pressure gauge (with limit indicator)	●	●	●
			G	Round type pressure gauge (with limit indicator)	●	●	●
			M	Round type pressure gauge (with color zone)	●	●	●
		Digital pressure switch	E1	Output: NPN output / Electrical entry: Wiring bottom entry	●	●	●
			E2	Output: NPN output / Electrical entry: Wiring top entry	●	●	●
			E3	Output: PNP output / Electrical entry: Wiring bottom entry	●	●	●
	E4	Output: PNP output / Electrical entry: Wiring top entry	●	●	●		
	+						
⑤ Attachment	c	Pressure switch	Nil	Without attachment	●	●	●
			S ^{Note 4)}	Mounting position: AW+S+AFM	●	●	●
+							
d	3-port valve for residual pressure release	Nil	Without attachment	●	●	●	
		V	Mounting position: AW+AFM+V	●	●	●	
		V1 ^{Note 5)}	Mounting position: V+AW□K+AFM	●	●	●	
+							
⑥ Semi-standard	e	Set pressure	Nil	0.05 to 0.85 MPa setting	●	●	●
			1 ^{Note 6)}	0.02 to 0.2 MPa setting	●	●	●
	+						
	f	Bowl ^{Note 7)}	Nil	Polycarbonate bowl	●	●	●
			2	Metal bowl	●	●	●
			6	Nylon bowl	●	●	●
			8	Metal bowl with level gauge	—	●	●
			C	With bowl guard	●	—	—
			6C	Nylon bowl with bowl guard	●	—	—
	+						
	g	Filter regulator Mist separator drain port ^{Note 8)}	Nil	With drain cock	●	●	●
J ^{Note 9)}			Drain guide 1/8	●	—	—	
			Drain guide 1/4	—	●	●	
W ^{Note 10)}			Drain cock with barb fitting: For ø6 x ø4 nylon tube	—	●	●	
+							
h	Exhaust mechanism	Nil	Relieving type	●	●	●	
		N	Non-relieving type	●	●	●	
+							
i	Flow direction	Nil	Flow direction: Left to right	●	●	●	
		R	Flow direction: Right to left	●	●	●	

Air Combination Series AC20D to AC40D

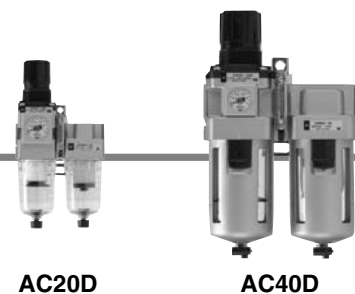

		Symbol	Description	①			
				Body size			
				20	30	40	
⑥	Semi-standard	j	Pressure unit	Nil	●	●	
				Z ^{Note 11)}	○ ^{Note 13)}	○ ^{Note 13)}	○ ^{Note 13)}
				ZA ^{Note 12)}	△ ^{Note 14)}	△ ^{Note 14)}	△ ^{Note 14)}

Note 1) Drain guide is NPT1/8 (applicable to the AC20D) and NPT1/4 (applicable to the AC30D to AC40D). The auto drain port comes with $\phi 3/8"$ one-touch fitting (applicable to the AC30D to AC40D).
 Note 2) Drain guide is G1/8 (applicable to the AC20D) and G1/4 (applicable to the AC30D to AC40D).
 Note 3) Option G, M are not assembled and supplied loose at the time of shipment.
 Note 4) The bracket position varies depending on the pressure switch mounting.

Note 5) The regulator is equipped with a backflow function in this configuration. Additionally, for safety purposes, please check that the pressure in the outlet side is turned to the atmospheric pressure once the pressure in the outlet side is exhausted, by using a pressure gauge, etc.
 Note 6) The only difference from the standard specifications is the adjusting spring for the regulator. It does not restrict the setting of 0.2 MPa or more. When the pressure gauge is attached, a 0.2 MPa pressure gauge will be fitted.
 Note 7) Refer to Chemical Data on page 287 when selecting a case material.
 Note 8) Float type auto drain: The combination of C and D is not possible.
 Note 9) Without a valve function

Note 10) Metal bowl: The combination of 2 and 8 is not possible.
 Note 11) For thread type: NPT. This product is for overseas use only according to the new Measurement Law. (The SI unit type is provided for use in Japan.) The digital pressure switch will be equipped with the unit conversion function, setting to psi initially. MPa and psi are shown together on the pressure unit. The combination of the round type pressure gauge with color zone "M" and a psi display "Z" is not orderable as a standard product. However, this combination is available as a special.
 Note 12) For options: E1, E2, E3, E4. This product is for overseas use only according to the new Measurement Law. (The SI unit is provided for use in Japan.)
 Note 13) ○: For thread type: NPT only
 Note 14) △: Select with options: E1, E2, E3, E4.

Standard Specifications

Model		AC20D	AC30D	AC40D	AC40D-06
Component	Filter regulator	AW20	AW30	AW40	AW40-06
	Mist separator	AFM20	AFM30	AFM40	AFM40-06
Port size		1/8, 1/4	1/4, 3/8	1/4, 3/8, 1/2	3/4
Pressure gauge port size ^{Note 1)}		1/8		1/4	
Fluid		Air			
Ambient and fluid temperature ^{Note 2)}		-5 to 60°C (with no freezing)			
Proof pressure		1.5 MPa			
Maximum operating pressure		1.0 MPa			
Minimum operating pressure		0.05 MPa			
Set pressure range		0.05 to 0.85 MPa			
Relief pressure		Set pressure + 0.05 MPa [at relief flow rate of 0.1 ℓ /min (ANR)]			
Nominal filtration rating		AF: 5 μ m, AFM: 0.3 μ m (99.9% filtered particle size)			
Rated flow (ℓ /min (ANR)) ^{Note 3)}		150	330	800	800
Outlet side oil mist concentration		Max. 1.0 mg/m ³ (ANR) (\approx 0.8 ppm) ^{Note 4) Note 5)}			
Bowl material		Polycarbonate			
Bowl guard		Semi-standard	Standard		
Regulator construction		Relieving type			
Mass (kg)		0.37	0.74	1.38	1.43

Note 1) Pressure gauge connection threads are not available for F.R.L. unit with a square embedded type pressure gauge or with a digital pressure switch (AC20D to AC40D).
 Note 2) -5 to 50°C for the products with the digital pressure switch
 Note 3) Conditions: Mist separator inlet pressure: 0.5 MPa; The rated flow varies depending on the inlet pressure. Keep the air flow within the rated flow to prevent an outflow of lubricant to the outlet side.
 Note 4) When the compressor oil mist discharge concentration is 30 mg/m³ (ANR).
 Note 5) Bowl O-ring and other O-rings are slightly lubricated.

AC

AF□

AR

AL

AW□

A□G

AV

AF800
AF900

Series AC20D to AC40D

Dimensions

AC20D

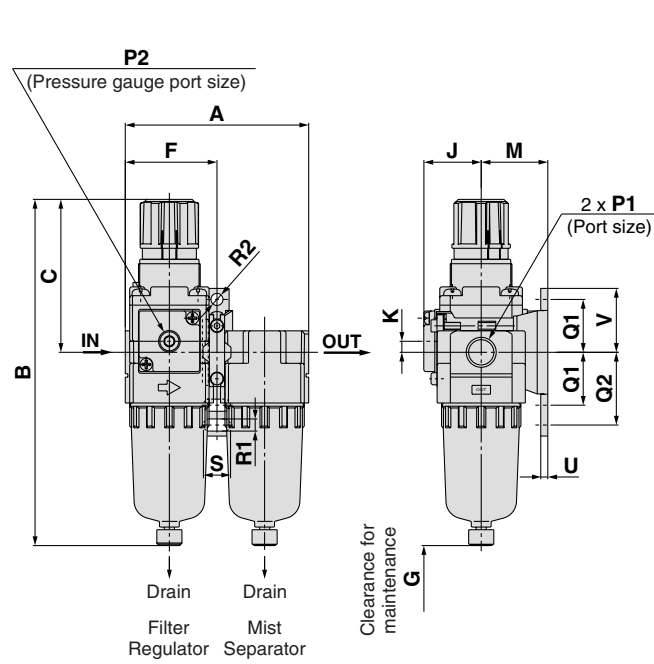

AC30D to AC40D-06

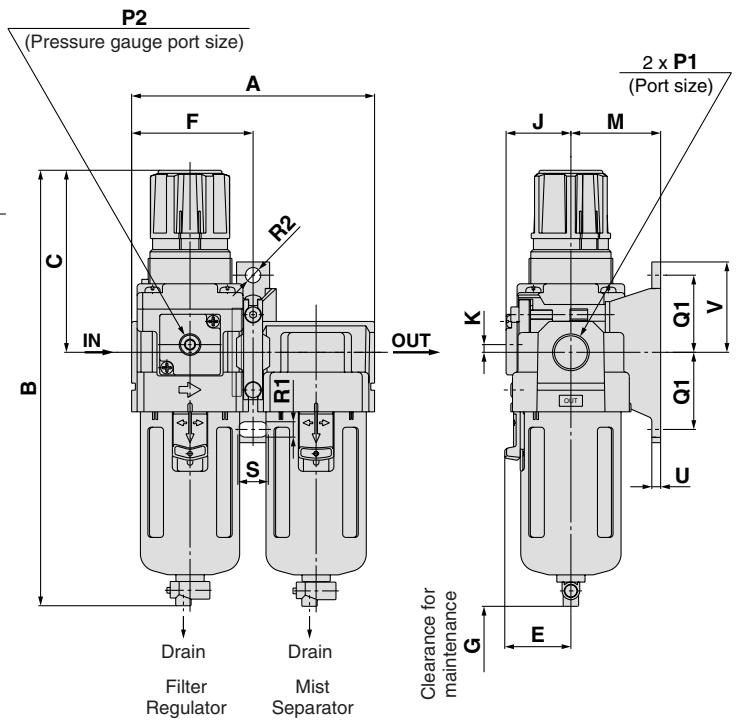

Applicable model	AC20D to AC40D-06			
Option	Square embedded type pressure gauge	Digital pressure switch	Round type pressure gauge	Round type pressure gauge (with color zone)
Dimensions				

Applicable model	AC20D				AC30D to AC40D-06			
	Optional/Semi-standard specifications	With auto drain (N.C.)	Metal bowl	With drain guide	With auto drain (N.O./N.C.)	Metal bowl	Metal bowl with level gauge	With drain guide
Dimensions								

Model	Standard specifications										Optional specifications							
	P1	P2	A	B (Note)	C	E	F	G	J	K	Square type pressure gauge	Digital pressure switch	Round type pressure gauge	Round type pressure gauge (with color zone)				
AC20D	1/8, 1/4	1/8	83	160	73	—	41.5	45	26	5	□28	27	□27.8	37.5	ø37.5	63	ø37.5	63
AC30D	1/4, 3/8	1/8	110	201	86	30	55	55	29.5	3.5	□28	30.5	□27.8	41	ø37.5	66	ø37.5	66
AC40D	1/4, 3/8, 1/2	1/4	145	239	92	38	72.5	80	37.5	1.5	□28	38.5	□27.8	49	ø42.5	76	ø42.5	76
AC40D-06	3/4	1/4	155	242	93	38	77.5	80	37.5	1.2	□28	38.5	□27.8	49	ø42.5	76	ø42.5	76

Model	Optional specifications									Semi-standard specifications				
	Bracket mount									With auto drain	With barb fitting	With drain guide	Metal bowl	Metal bowl with level gauge
	M	Q1	Q2	R1	R2	S	U	V	B	B	B	B	B	
AC20D	30	24	33	5.5	ø5.5	12	3.2	29	177	—	164	160	—	
AC30D	41	35	—	7	ø7	14	4	41	242	209	208	214	234	
AC40D	50	40	—	9	ø9	18	4	48	278	247	246	252	272	
AC40D-06	50	40	—	9	ø9	18	4.6	48	282	251	249	255	275	

Note) The total length of B dimension is the length when the filter regulator knob is unlocked.

Air Combination Series AC Options/Attachments

Options/Attachments Part No.

Section	Model		Part no.							
			For AC10	For AC20	For AC25	For AC30	For AC40-06	For AC50	For AC55	For AC60
			For AC10A	For AC20A	—	For AC30A	For AC40A	For AC40A-06	For AC50A	—
Option	Round type	Standard	G27-10-R1	G36-10-□01			G46-10-□02			
		0.02 to 0.2 MPa setting	G27-10-R1 (Note 3)	G36-2-□01			G46-2-□02			
	Round type (with color zone)	Standard	—	G36-10-□01-L			G46-10-□02-L			
		0.02 to 0.2 MPa setting	—	G36-2-□01-L			G46-2-□02-L			
	Square embedded type	Standard	—	GC3-10AS [GC3P-010AS (Pressure gauge cover only)]						
		0.02 to 0.2 MPa setting	—	GC3-2AS [GC3P-010AS (Pressure gauge cover only)]						
	Digital pressure switch	NPN output/Wiring bottom entry	—	ISE35-N-25-MLA [ISE35-N-25-M (Switch body only)] (Note 4)						
		NPN output/Wiring top entry	—	ISE35-R-25-MLA [ISE35-R-25-M (Switch body only)] (Note 4)						
		PNP output/Wiring bottom entry	—	ISE35-N-65-MLA [ISE35-N-65-M (Switch body only)] (Note 4)						
		PNP output/Wiring top entry	—	ISE35-R-65-MLA [ISE35-R-65-M (Switch body only)] (Note 4)						
Float type auto drain	N.O.	—	—	AD38	AD48					
	N.C.	AD17	AD27	AD37	AD47					
Attachment	Spacer	—	Y100	Y200	Y300	Y400	Y500	Y600		
	Check valve (Note 6) (Note 7)	—	AKM2000-□01 (□02)	AKM3000-(□01) □02		AKM4000-(□02) □03		—	—	—
	Pressure switch (Note 7)	—	IS1000M-20	IS1000M-30		IS1000M-40	IS1000M-50	IS1000M-60		
	T-interface (Note 6) (Note 7)	Y110-M5	Y210-□01 (□02)	Y310-(□01) □02		Y410-(□02) □03	Y510-(□02) □03	Y610-□03 (□04)	Y610-(□03) □04	
	3-port valve for residual pressure release (Note 7)	—	VHS20-□01 □02	VHS30-□02 □03		VHS40-□03 □04	VHS40-□06	VHS50-□06 □10	—	—
	Piping adapter (Note 7)	E100-M5	□01 E200-□02 □03	□02 E300-□03 □04		□02 E400-□03 □04 □06	E500-□06	E600-□06 □10		
	Pressure switch with piping adapter (Note 7)	—	□01 IS1000E-20 □02 □03	□02 IS1000E-30 □03 □04		□02 IS1000E-40 □03 □04 □06	—	—	—	—
	Cross spacer (Note 7)	Y14-M5	Y24-□01 □02	Y34-□01 □02		Y44-□02 □03	Y54-□03 □04	—	—	—

Note 1) □ in part numbers for a round pressure gauge indicates a type of connection thread. No indication is necessary for R; however, indicate N for NPT. Please contact SMC regarding the connection thread NPT and pressure gauge supply for psi unit specifications.

Note 2) Including one O-ring and 2 mounting screws

Note 3) Standard pressure gauge

Note 4) Lead wire with connector (2 m), adapter, lock pin, O-ring (1 pc.), mounting screw (2 pcs.) are attached. []: Switch body only.

Also, regarding how to order the digital pressure switch, please refer to page 388.

Note 5) Minimum operating pressure: N.O. type-0.1 MPa; N.C. type-0.1 MPa (AD17/27) and 0.15 MPa (AD37/47). Please contact SMC for psi and °F unit specifications.

Note 6) For F.R.L. units, port sizes without () are standard specifications.

Note 7) Separate interfaces are required for modular unit.

Check Valve: (K) 1/8, 1/4, 3/8

RoHS

A check valve with intermediate air release port can be easily installed to prevent a backflow of lubricant when redirecting the air flow and releasing the air on the outlet side of the regulator.

AKM 30 00 - □ 01

① ② ③

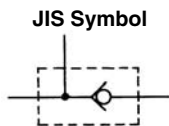

Symbol	Description	① Body size		
		20	30	40
② Thread type	Nil	●	●	●
	N	●	●	●
	F	●	●	●
③ By-pass port size	01	●	●	—
	02	●	●	●
	03	—	—	●

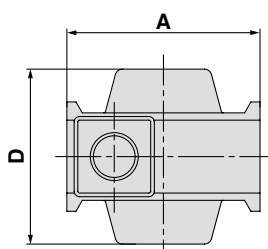

Specifications

Model	Effective area (mm ²)
AKM2000	28
AKM3000	55
AKM4000	111

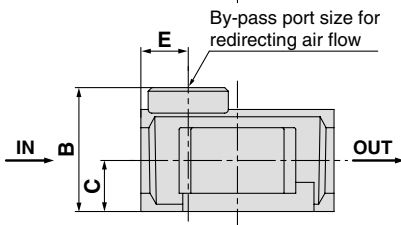

Model	By-pass port size	A	B	C	D	E	Applicable model
AKM2000	1/8, 1/4	40	28	11	40	11	AC20, AC20A
AKM3000	1/8, 1/4	53	34	14	48	13	AC25, AC25A AC30, AC30A
AKM4000	1/4, 3/8	70	42	18	54	15	AC40, AC40A (Note)

Note) A pressure switch cannot be mounted on the AC40□-06.
* Refer to the attachment table above for standard by-pass port sizes applicable to the AC.

Be sure to use above check valves when redirecting the air flow on the inlet side of the lubricator. Threads for IN and OUT ports are not machined.

Series AC

Pressure Switch: (S)

A compact integrated pressure switch can be easily installed and facilitates the pressure detection of the line.

IS1000M - **30** -

① ②

	Symbol	Description		
		Lead wire length	Set pressure range	Pressure display
② Option	Nil	0.5 m	0.1 to 0.4 MPa	MPa
	P ^{Note)}	0.5 m	0.1 to 0.4 MPa	MPa/psi dual scale
	X202	0.5 m	0.1 to 0.6 MPa	MPa
	X202-P ^{Note)}	0.5 m	0.1 to 0.6 MPa	MPa/psi dual scale
	X201	3 m	0.1 to 0.4 MPa	MPa
	X201-P ^{Note)}	3 m	0.1 to 0.4 MPa	MPa/psi dual scale
	X215	3 m	0.1 to 0.6 MPa	MPa
X215-P ^{Note)}	3 m	0.1 to 0.6 MPa	MPa/psi dual scale	

① Body size				
20	30	40	50	60
●	●	●	●	●
●	●	●	●	●
●	●	●	●	●
●	●	●	●	●
●	●	●	●	●
●	●	●	●	●
●	●	●	●	●

JIS Symbol

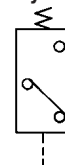

Pressure switch

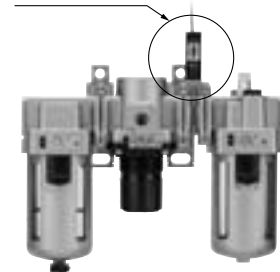

Note) This product is for overseas use only according to the new Measurement Law. (The SI unit type is provided for use in Japan.)

Specifications

Fluid	Air
Ambient and fluid temperature	-5 to 60°C (with no freezing)
Proof pressure	1.0 MPa
Maximum operating pressure	0.7 MPa
Set pressure range (when OFF)	0.1 to 0.4 MPa
Hysteresis	0.08 MPa or less

Switch Characteristics

Contact point configuration	1a
Maximum contact point capacity	2 VA (AC), 2 W (DC)
Operating voltage: AC, DC	100 V or less
Maximum operating current	12 V to 24 VAC, DC: 50 mA
	48 VAC, DC: 40 mA 100 VAC, DC: 20 mA

Note) For detailed specifications on the IS1000 series, please refer to series IS1000 in Best Pneumatics No.6.

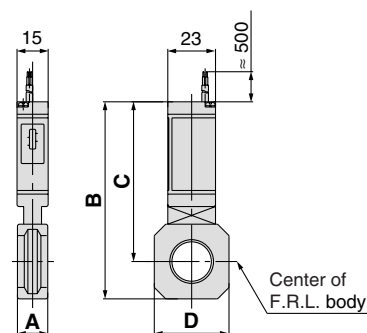

Model	A	B	C	D	Applicable model
IS1000M-20	11	76	66	28	AC20□
IS1000M-30	13	86	72	30	AC25□, AC30□
IS1000M-40	15	95	77	36	AC40□
IS1000M-50	17	99	79	44	AC40□-06
IS1000M-60	22	92.5	68.5	53	AC50□, AC55□, AC60□

Note) Separate spacers are required for modular unit.

T-interface: (T) M5 x 0.8, 1/8, 1/4, 3/8, 1/2

Using a T-interface facilitates the redirection of air flow.

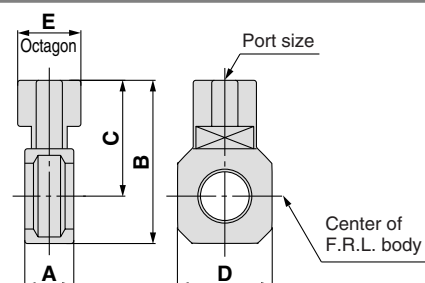
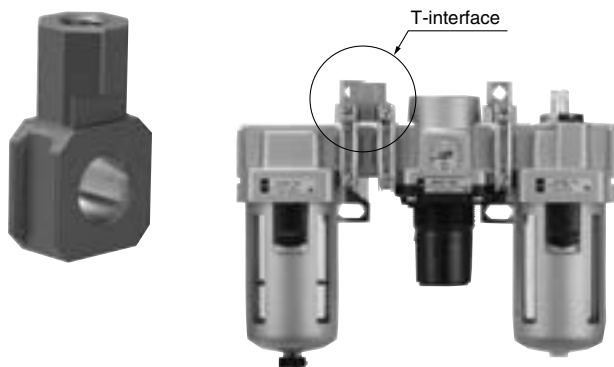

Model	Port size	A	B	C	D	E	Applicable model
Y110-M5	M5 x 0.8	11	19	12	14	8	AC10, AC10B
Y210-□01	1/8	15	42	32	28	19	AC20, AC20B, AC20C
Y210-□02	1/4		53	39	30	19	
Y310-□01	1/8	19	62	44	36	24	AC40, AC40B, AC40C
Y310-□02	1/4		66	46	44	24	
Y410-□02	1/4	22	81	57	53	30	AC50, AC55, AC60, AC50B, AC55B, AC60B
Y410-□03	3/8		81	57	53	30	

Note 1) □ in model numbers indicates a thread type. No indication is necessary for Rc; however, indicate N for NPT, and F for G.

Note 2) Separate interfaces are required for modular unit.

* Refer to the attachment table on page 321 for standard port sizes when using with the AC.

Caution on Mounting

If a T-interface is used on the IN side of the lubricator, lubricant may be mixed. Use the AKM series check valve to avoid such possibility.

Pressure Relief 3 Port Valve: (V)

With the use of a 3-port valve for residual pressure release, pressure left in the line can be easily exhausted.

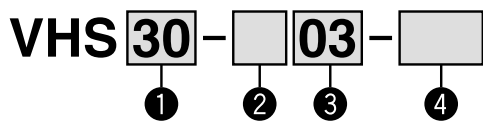

- Semi-standard: Select one each for a to b.
- Semi-standard symbol: When more than one specification is required, indicate in alphabetic order.
Example) VHS30-03-RZ

	Symbol	Description	① Body size				
			20	30	40	50	
② Thread type	Nil	Rc	●	●	●	●	
	N (Note)	NPT	●	●	●	●	
	F (Note)	G	●	●	●	●	
③ Port size	+						
	01	1/8	●	—	—	—	
	02	1/4	●	●	●	—	
	03	3/8	—	●	●	—	
	04	1/2	—	—	●	—	
	06	3/4	—	—	—	●	
④ Semi-standard	a Flow direction	Nil	Flow direction: Left to right	●	●	●	●
		R	Flow direction: Right to left	●	●	●	●
	b Pressure unit	Nil	Name plate in imperial units: MPa	●	●	●	●
		Z (Note)	Name plate in imperial units: psi	●	●	●	●

JIS Symbol

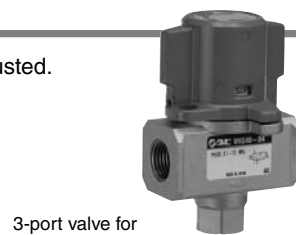
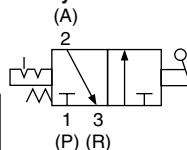

3-port valve for residual pressure release

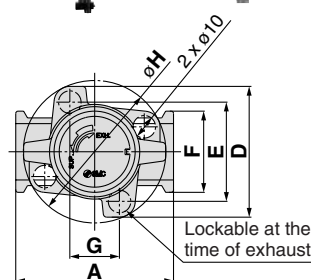
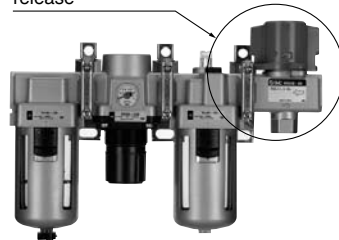

Note) For thread type: NPT only. This product is for overseas use only according to the new Measurement Law. (The SI unit type is provided for use in Japan.)

Specifications

Model	Port size		Effective area (mm ²) (): Cv factor	
	IN, OUT	EXH	IN→OUT	OUT→EXH
VHS20	1/8	1/8	10 (0.54)	11 (0.60)
	1/4		14 (0.76)	16 (0.87)
VHS30	1/4	1/4	16 (0.87)	14 (0.76)
	3/8		31 (1.68)	29 (1.57)
VHS40	1/4	3/8	27 (1.46)	36 (1.75)
	3/8		38 (2.06)	40 (2.08)
	1/2		55 (2.98)	42 (2.12)
VHS40-06	3/4	1/2	77 (4.17)	49 (2.12)
VHS50	3/4	1/2	82 (4.44)	50 (2.85)
	1		125 (6.78)	53 (2.93)

Note) Use an air filter on the IN side for operating protection.

Caution on Mounting

1. If a tube, stop valve or silencer is connected to the exhaust port of the VHS20/30, the effective sectional area should be larger than the figure indicated in the following table, to prevent malfunction caused by back pressure. (This is not applicable to the VHS40/50.)

Model	Effective area (mm ²)
VHS20	5
VHS30	5

Cross Spacer: M5 x 0.8, 1/8, 1/4, 3/8, 1/2

Pipings are possible in all 4 directions.
IN/OUT ports are not machined for threads.
Please contact SMC if threaded (machined) ports are required.



Caution on Mounting

1. When mounting a cross interface directly on the IN side of the lubricator, be sure to use the AKM series check valve between the lubricator and cross interface.
2. Factory mounting of a cross interface on the AC model is available as a special order.

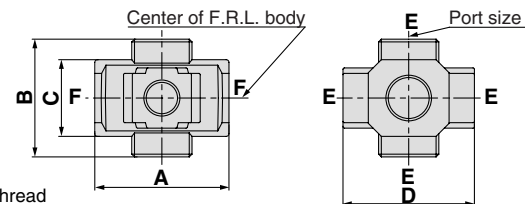

E: 4 x Rc
F: Without thread

Model	Port size	A	B	C	D	Applicable model
Y14-M5	M5	23	16	14	25	AC10□
Y24-□01	1/8	40	40	22	40	AC20□
Y24-□02	1/4					
Y34-□01	1/8	49	43	28	48	AC25□, AC30□
Y34-□02	1/4					
Y44-□02	1/4	60	48	36	54	AC40□
Y44-□03	3/8					
Y54-□03	3/8					
Y54-□04	1/2	72	62	40	62	AC40□-06

Note 1) □ in model numbers indicates a thread type. No indication is necessary for Rc; however, indicate N for NPT, and F for G.

Note 2) If threaded IN/OUT ports are required, they are available as a special order. Please contact SMC.

Series AC

Piping Adapter: M5 x 0.8, 1/8, 1/4, 3/8, 1/2, 3/4, 1

A piping adapter allows installation/removal of the component without removing the piping and thus makes maintenance easier.



Piping adapter

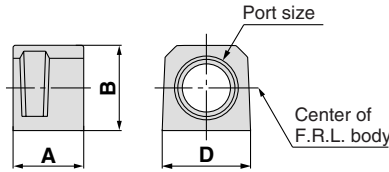

Model (Note 1)	Port size	A	B	D	Applicable model
E100-M5	M5 x 0.8	10	14	14	AC10□, AW10, AF10, AR10, AL10
E200-□01	1/8	30	23.5	28	AC20□
E200-□02	1/4				AF20, AR20□, AW20□
E200-□03	3/8				AL20, AFM20, AFD20, AWM20, AWD20
E300-□02	1/4	32	30	30	AC25□, AC30□
E300-□03	3/8				AF30, AR30□, AW30□
E300-□04	1/2	32	36	36	AL30, AFM30, AFD30, AWM30, AWD30
E400-□02	1/4				AC40□
E400-□03	3/8				AF40, AR40□, AW40□
E400-□04	1/2				AL40, AFM40, AFD40
E400-□06	3/4				AWM40, AWD40
E500-□06	3/4	32	40	44	AC40□-06, AF40-06, AR40□-06, AW40□-06, AL40-06, AFM40-06, AFD40-06
E600-□06	3/4	35	48	53	AC50, AC55, AC60, AC50A
E600-□10	1				AC60A, AC50B, AC55B
					AC60B, AF50, AF60, AR50□
					AR60□, AL50, AL60, AW60□

Note 1) □ in model numbers indicates a thread type. No indication is necessary for Rc; however, indicate N for NPT, and F for G.

Note 2) Separate interfaces are required for modular unit.

* Factory mounting of a piping adapter on the AC models is available as a special order.

Pressure Switch with Piping Adapter

IS1000E - 30 □ 03 - □

1 2 3 4

	Symbol	Description	① Body size		
			20	30	40
② Thread type	Nil	Rc	●	●	●
	N (Note)	NPT	●	●	●
	F (Note)	G	●	●	●
③ Port size	+				
	01	1/8	●	—	—
	02	1/4	●	●	—
	03	3/8	●	●	●
	04	1/2	—	●	●
④ Accessory	+				
	Symbol	Lead wire length	Regulating pressure range	Pressure display	Mounting position
	Nil	0.5 m	0.1 to 0.4 MPa	MPa	Right
	X250	0.5 m	0.1 to 0.4 MPa	MPa	Left
	P (Note)	0.5 m	0.1 to 0.4 MPa	MPa/psi dual scale	Right
	X250-P (Note)	0.5 m	0.1 to 0.4 MPa	MPa/psi dual scale	Left
	X202	0.5 m	0.1 to 0.6 MPa	MPa	Right
	X252	0.5 m	0.1 to 0.6 MPa	MPa	Left
	X202-P (Note)	0.5 m	0.1 to 0.6 MPa	MPa/psi dual scale	Right
	X252-P (Note)	0.5 m	0.1 to 0.6 MPa	MPa/psi dual scale	Left
	X201	3 m	0.1 to 0.4 MPa	MPa	Right
	X251	3 m	0.1 to 0.4 MPa	MPa	Left
	X201-P (Note)	3 m	0.1 to 0.4 MPa	MPa/psi dual scale	Right
	X251-P (Note)	3 m	0.1 to 0.4 MPa	MPa/psi dual scale	Left
	X215	3 m	0.1 to 0.6 MPa	MPa	Right
	X253	3 m	0.1 to 0.6 MPa	MPa	Left
X215-P (Note)	3 m	0.1 to 0.6 MPa	MPa/psi dual scale	Right	
X253-P (Note)	3 m	0.1 to 0.6 MPa	MPa/psi dual scale	Left	

Note) For thread type: NPT only. This product is for overseas use only according to the new Measurement Law. (The SI unit type is provided for use in Japan.)

Specifications

Fluid	Air
Ambient and fluid temperature	-5 to 60°C (with no freezing)
Proof pressure	1.0 MPa
Maximum operating pressure	0.7 MPa
Set pressure range (when OFF)	0.1 to 0.4 MPa
Hysteresis	0.08 MPa or less

Switch Characteristics

Contact point configuration	1a
Maximum contact point capacity	2VA(AC), 2W(DC)
Operating voltage: AC, DC	100V or less
Maximum operating current	12V to 24V AC, DC: 50 mA 48V AC, DC: 40 mA 100V AC, DC: 20 mA

JIS Symbol

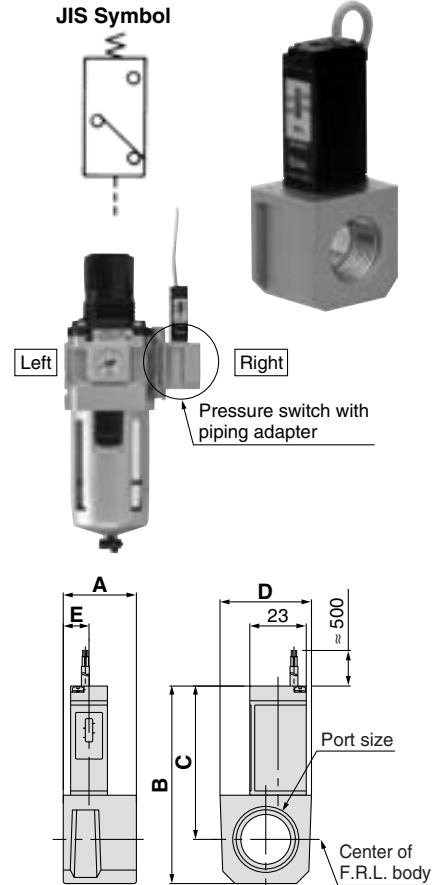

Model (Note 1)	Port size	A	B	C	D	E	Applicable model
IS1000E-20□01	1/8	30	68	57	28	16	AC20□
IS1000E-20□02	1/4						AR20□, AW20□
IS1000E-20□03	3/8						AWM20, AWD20
IS1000E-30□02	1/4	32	74.5	60.5	30	13	AC25□, AC30□
IS1000E-30□03	3/8						AR25□, AR30□, AW30□
IS1000E-30□04	1/2						AWM30, AWD30
IS1000E-40□02	1/4	32	80.5	62.5	37	12.5	Note 2)
IS1000E-40□03	3/8						AC40□
IS1000E-40□04	1/2						AR40□, AW40□
IS1000E-40□06	3/4						AWM40, AWD40

Note 1) □ in the model numbers indicates a thread type. No indication is necessary for Rc; however, indicate N for NPT, and F for G.

Note 2) Cannot be mounted on the AC40□-06 and AW40□-06.

Note 3) Separate interfaces are required for modular unit.

* The pressure switch on the AC40□-06 and above and the AW40□-06 can be mounted by screwing IS1000-01 into the piping adapter E500-□06-X501 or E600-□06-X501 to E600-□10-X501 (with top-face thread Rc 1/8). Products with a premounted switch are available as a special order. Please contact SMC regarding their availability.

Series AC Spacers/Brackets Accessories

Spacer

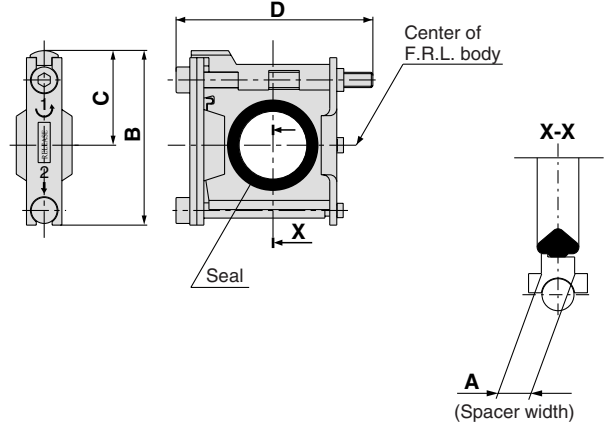
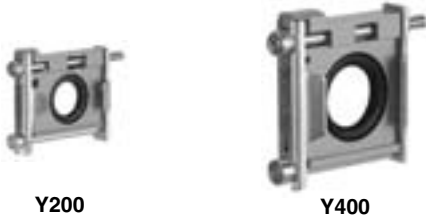

Model	A	B	C	D	Applicable model
Y100	6	27	15	33	AC10, AC10A, AC10B
Y200	3	35.5	18.5	48	AC20□
Y300	4	47	26	59	AC25□, AC30□
Y400	5	57	31	65	AC40□
Y500	5	61	33	75	AC40□-06
Y600	6	75.5	41	86	AC50, AC55, AC60 AC50A, AC60A AC50B, AC55B, AC60B

Replacement Parts

Description	Material	Part no.					
		Y100	Y200	Y300	Y400	Y500	Y600
Seal	HNBR ^{Note 2)}	Y100P-060AS ^{Note 1)}	Y200P-061S	Y300P-060S	Y400P-060S	Y500P-060S	Y600P-060S

Note 1) Assembly of 2 O-rings

Note 2) NBR is used for Y100 spacer because of no direct contact with fluid.

Spacer with Bracket

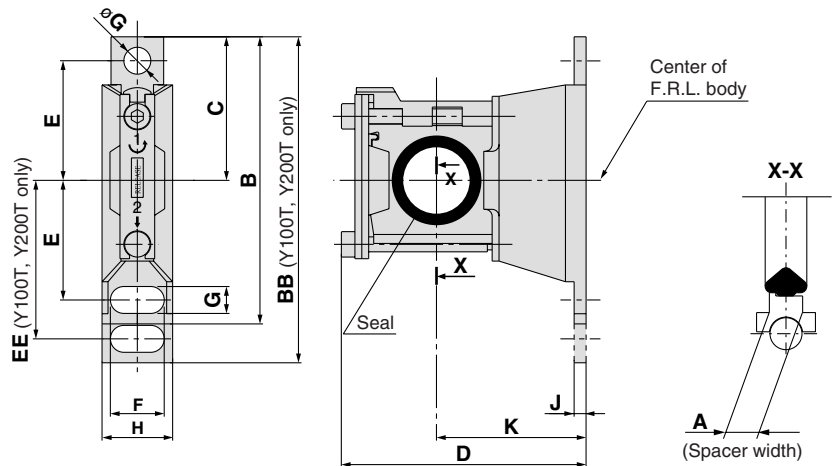
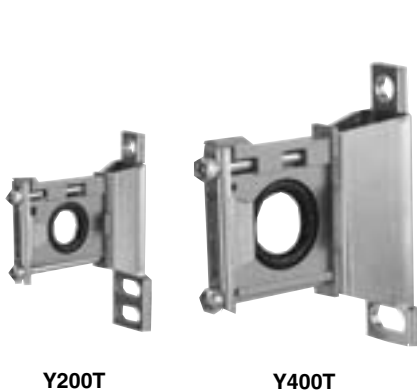

Model	A	B	BB	C	D	E	EE	F	G	øG	H	J	K	Applicable model
Y100T	6	—	56	24.5	40.5	20	27	6.8	4.5	4.5	14	2.8	25	AC10□
Y200T	3	—	67	29	53	24	33	12	5.5	5.5	19	3.2	30	AC20□
Y300T	4	82	—	41	68	35	—	14	7	7	21	4	41	AC25□, AC30□
Y400T	5	96	—	48	81.5	40	—	18	9	9	26	4	50	AC40□
Y500T	5	96	—	48	86	40	—	18	9	9	27	4.6	50	AC40□-06
Y600T	6	120	—	60	112	50	—	20	11	11	31	6.4	70	AC50, AC55, AC60, AC50A, AC60A, AC50B, AC55B, AC60B

Replacement Parts

Description	Material	Part no.					
		Y100T	Y200T	Y300T	Y400T	Y500T	Y600T
Seal	HNBR ^{Note 2)}	Y100P-060AS ^{Note 1)}	Y200P-061S	Y300P-060S	Y400P-060S	Y500P-060S	Y600P-060S

Note 1) Assembly of 2 O-rings

Note 2) NBR is used for Y100T spacer because of no direct contact with fluid.

- AC
- AF□
- AR
- AL
- AW□
- A□G
- AV
- AF800
- AF900

Series AC

Mounting Position for Spacer with Bracket

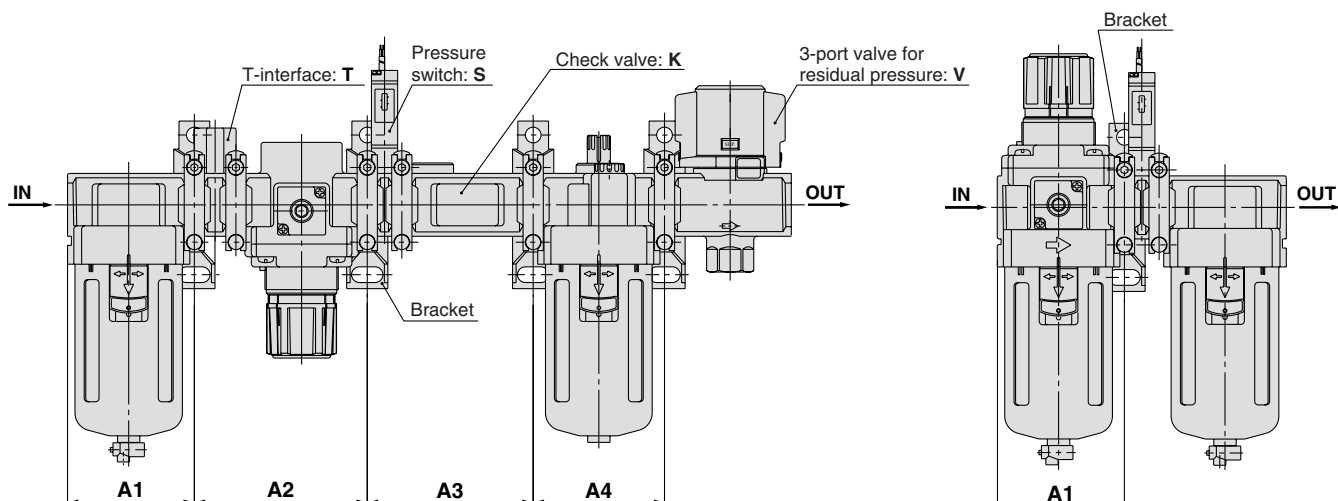

Attachment Model	K			S			T			V			KS			KT			KV				KST		
	A1	A2	A3	A1	A2	A3	A1	A2	A3	A1	A2	A3	A1	A2	A3	A1	A2	A3	A1	A2	A3	A4	A1	A2	A3
AC10	—	—	—	—	—	—	28	48	—	—	—	—	—	—	—	—	—	—	—	—	—	—	—	—	
AC20	41.5	43	43	41.5	43	41.5	61	41.5	43	43	41.5	43	57	41.5	61	43	41.5	43	43	43	41.5	61	57	57	
AC25	55	57	57	55	57	55	76	55	57	57	55	57	74	55	76	57	55	57	57	57	55	57	76	74	
AC30	55	57	57	55	57	55	76	55	57	57	55	57	74	55	76	57	55	57	57	57	55	57	76	74	
AC40	72.5	75	75	72.5	75	72.5	99	72.5	75	75	72.5	75	95	72.5	99	75	72.5	75	75	75	72.5	99	95	95	
AC40-06	—	—	—	77.5	80	77.5	104	77.5	80	80	—	—	—	—	—	—	—	—	—	—	—	—	—	—	
AC50	—	—	—	93	96	93	124	93	96	96	—	—	—	—	—	—	—	—	—	—	—	—	—	—	
AC55	—	—	—	98	96	98	124	—	—	—	—	—	—	—	—	—	—	—	—	—	—	—	—	—	
AC60	—	—	—	98	101	98	129	—	—	—	—	—	—	—	—	—	—	—	—	—	—	—	—	—	

Attachment Model	KSV				KTV				KSTV				ST		SV			STV			TV			
	A1	A2	A3	A4	A1	A2	A3	A4	A1	A2	A3	A4	A1	A2	A1	A2	A3	A1	A2	A3	A1	A2	A3	
AC10	—	—	—	—	—	—	—	—	—	—	—	—	—	—	—	—	—	—	—	—	—	—	—	—
AC20	41.5	43	57	43	41.5	61	43	43	41.5	61	57	43	41.5	61	41.5	43	57	41.5	61	57	41.5	61	43	43
AC25	55	57	74	57	55	76	57	57	55	76	74	57	55	76	55	57	74	55	76	74	55	76	57	57
AC30	55	57	74	57	55	76	57	57	55	76	74	57	55	76	55	57	74	55	76	74	55	76	57	57
AC40	72.5	75	95	75	72.5	99	75	75	72.5	99	95	75	72.5	99	72.5	75	95	72.5	99	95	72.5	99	75	75
AC40-06	—	—	—	—	—	—	—	—	—	—	—	—	—	77.5	104	77.5	80	102	77.5	104	102	77.5	104	80
AC50	—	—	—	—	—	—	—	—	—	—	—	—	—	93	124	93	96	124	93	124	124	93	124	96
AC55	—	—	—	—	—	—	—	—	—	—	—	—	—	98	124	98	—	—	—	—	—	—	—	—
AC60	—	—	—	—	—	—	—	—	—	—	—	—	—	98	129	—	—	—	—	—	—	—	—	—

Attachment Model	K		S		V		KS		KV			KSV			SV	
	A1	A2	A1	A2	A1	A2	A1	A2	A1	A2	A3	A1	A2	A3	A1	A2
AC20A	41.5	43	41.5	41.5	43	41.5	57	41.5	43	43	41.5	57	43	41.5	57	
AC30A	55	57	55	55	57	55	74	55	57	57	55	74	57	55	74	
AC40A	72.5	75	72.5	72.5	75	72.5	95	72.5	75	75	72.5	95	75	72.5	95	
AC40A-06	—	—	77.5	77.5	80	—	—	—	—	—	—	—	—	77.5	102	
AC50A	—	—	98	98	96	—	—	—	—	—	—	—	—	98	124	
AC60A	—	—	98	—	—	—	—	—	—	—	—	—	—	—	—	



Attachment Model	S		T		V		V1		SV		SV1		TV		TV1	
	A1	A1	A1	A2	A1	A2	A1	A2	A1	A2	A1	A2	A1	A2	A1	A2
AC10B	—	28	—	—	—	—	—	—	—	—	—	—	—	—	—	—
AC20B	41.5	41.5	41.5	43	41.5	43	41.5	57	41.5	43	41.5	61	41.5	43	41.5	43
AC25B	55	55	55	57	55	57	55	74	55	57	55	76	55	57	55	57
AC30B	55	55	55	57	55	57	55	74	55	57	55	76	55	57	55	57
AC40B	72.5	72.5	72.5	75	72.5	75	72.5	95	72.5	75	72.5	99	72.5	75	72.5	75
AC40B-06	77.5	77.5	77.5	80	77.5	80	77.5	102	77.5	80	77.5	104	77.5	80	77.5	80
AC50B	93	93	93	96	93	96	93	124	93	96	93	124	93	96	93	96
AC55B	98	98	—	—	—	—	—	—	—	—	—	—	—	—	—	—
AC60B	98	98	—	—	—	—	—	—	—	—	—	—	—	—	—	—

Attachment Model	S		T		V			V1			SV			SV1			TV			TV1		
	A1	A2	A1	A2	A1	A2	A3	A1	A2	A3	A1	A2	A3	A1	A2	A3	A1	A2	A3	A1	A2	A3
AC20C	41.5	43	41.5	43	41.5	43	43	41.5	43	43	41.5	43	57	41.5	43	43	41.5	43	61	41.5	43	43
AC25C	55	57	55	57	55	57	57	55	57	57	55	57	74	55	57	57	55	57	76	55	57	57
AC30C	55	57	55	57	55	57	57	55	57	57	55	57	74	55	57	57	55	57	76	55	57	57
AC40C	72.5	75	72.5	75	72.5	75	75	72.5	75	75	72.5	75	95	72.5	75	75	72.5	75	99	72.5	75	75
AC40C-06	77.5	80	77.5	80	77.5	80	80	77.5	80	80	77.5	80	102	77.5	80	80	77.5	80	104	77.5	80	80

Attachment Model	S		V		V1		SV		SV1		
	A1	A1	A2	A1	A2	A1	A2	A1	A2	A1	A2
AC20D	41.5	41.5	43	41.5	43	41.5	57	41.5	43	41.5	43
AC30D	55	55	57	55	57	55	74	55	57	55	57
AC40D	72.5	72.5	75	72.5	75	72.5	95	72.5	75	72.5	75
AC40D-06	77.5	77.5	80	77.5	80	77.5	102	77.5	80	77.5	80

A1: Dimensions from the end of the IN side to the center of the mounting hole for the first bracket.
A2: Mounting hole pitch between the first and the second brackets.
A3: Mounting hole pitch between the second and the third brackets.
A4: Mounting hole pitch between the third and the fourth brackets.

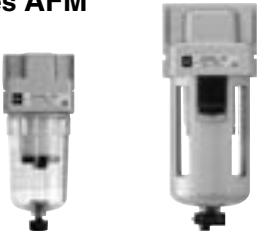
Modular Type Air Filters Series AF

Air Filter Series AF	Model	Port size	Filtration (μm)	Options
 <p data-bbox="165 898 480 931">Page 328 through to 336</p>	AF10	M5 x 0.8	5	Bracket Float type auto drain
	AF20	1/8, 1/4		
	AF30	1/4, 3/8		
	AF40	1/4, 3/8, 1/2		
	AF40-06	3/4		
	AF50	3/4, 1		
	AF60	1		
 <p data-bbox="165 1227 480 1261">Page 338 through to 344</p>	AFM20	1/8, 1/4	0.3	Bracket Float type auto drain
	AFM30	1/4, 3/8		
	AFM40	1/4, 3/8, 1/2		
	AFM40-06	3/4		
 <p data-bbox="165 1556 480 1590">Page 338 through to 344</p>	AFD20	1/8, 1/4	0.01	Bracket Float type auto drain
	AFD30	1/4, 3/8		
	AFD40	1/4, 3/8, 1/2		
	AFD40-06	3/4		

AC

AF□

AR

AL

AW□

A□G

AV

AF800
AF900

Air Filter

AF10 to AF60

JIS Symbol
Air Filter

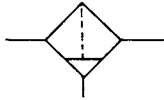

Air Filter with Auto Drain

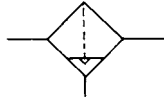

How to Order

AF **30** - **03** **BD** - **03** - **03**

① ② ③ ④ ⑤

Made to Order

(Refer to page 334 through to 336 for details.)

- Option/Semi-standard: Select one each for a to f.
- Option/Semi-standard symbol: When more than one specification is required, indicate in alphanumeric order.
Example) AF30-03BD-03

	Symbol	Description	①						
			Body size						
			10	20	30	40	50	60	
②	Thread type	Nil	Metric thread (M5)						
		N <small>Note 1)</small>	Rc						
		F <small>Note 2)</small>	NPT						
			G						
+									
③	Port size	M5	M5						
		01	1/8						
		02	1/4						
		03	3/8						
		04	1/2						
		06	3/4						
		10	1						
+									
④	a	Mounting	Nil	Without mounting option					
			B <small>Note 3)</small>	With bracket					
	+								
	b	Float type auto drain	Nil	Without auto drain					
C			Float type auto drain (N.C.)						
D			Float type auto drain (N.O.)						
+									
⑤	c	Bowl <small>Note 4)</small>	Nil	Polycarbonate bowl					
			2	Metal bowl					
			6	Nylon bowl					
			8	Metal bowl with level gauge					
			C	With bowl guard					
			6C	Nylon bowl with bowl guard					
	+								
	d	Drain port <small>Note 5)</small>	Nil	With drain cock					
			J <small>Note 6)</small>	Drain guide 1/8					
				Drain guide 1/4					
W <small>Note 7)</small>			Drain cock with barb fitting: For ø6 x ø4 nylon tube						
+									
e	Flow direction	Nil	Flow direction: Left to right						
		R	Flow direction: Right to left						
+									
f	Pressure unit	Nil	Name plate and caution plate for bowl in imperial units: MPa						
		Z <small>Note 8)</small>	Name plate and caution plate for bowl in imperial units: psi, °F						
			○ <small>Note 9)</small>	○ <small>Note 9)</small>	○ <small>Note 9)</small>	○ <small>Note 9)</small>	○ <small>Note 9)</small>	○ <small>Note 9)</small>	

Note 1) Drain guide is NPT1/8 (applicable to the AF20) and NPT1/4 (applicable to the AF30 to AF60). The auto drain port comes with ø3/8" one-touch fitting (applicable to the AF30 to AF60).

Note 2) Drain guide is G1/8 (applicable to the AF20) and G1/4 (applicable to the AF30 to AF60).

Note 3) A bracket is not assembled and supplied loose at the time of shipment. Including 2 mounting screws

Note 4) Refer to Chemical Data on page 287 when selecting a case material.

Note 5) Float type auto drain: The combination of C and D is not possible.

Note 6) Without a valve function

Note 7) Metal bowl: The combination of 2 and 8 is not possible.

Note 8) For thread type: M5 and NPT. This product is for overseas use only according to the new Measurement Law. (The SI unit type is provided for use in Japan.)

Note 9) ○: For thread type: M5 and NPT only

Standard Specifications

Model	AF10	AF20	AF30	AF40	AF40-06	AF50	AF60
Port size	M5 x 0.8	1/8, 1/4	1/4, 3/8	1/4, 3/8, 1/2	3/4	3/4, 1	1
Fluid	Air						
Ambient and fluid temperature	-5 to 60°C (with no freezing)						
Proof pressure	1.5 MPa						
Maximum operating pressure	1.0 MPa						
Nominal filtration rating	5 µm						
Drain capacity (cm ³)	2.5	8	25	45			
Bowl material	Polycarbonate						
Bowl guard	—	Semi-standard	Standard				
Mass (kg)	0.06	0.10	0.22	0.45	0.49	0.99	1.05

Options/Part No.

Optional specifications	Model						
	AF10	AF20	AF30	AF40	AF40-06	AF50	AF60
Bracket assembly ^{Note 1)}	—	AF20P-050AS	AF30P-050AS	AF40P-050AS	AF40P-070AS	AF50P-050AS	AF50P-050AS
Float type auto drain ^{Note 2) Note 3)}	N.C.	AD17	AD27	AD37	AD47		
	N.O.	—	—	AD38	AD48		

Semi-standard/Bowl Assembly Part No.

Semi-standard specifications					Model							
Bowl material	^{Note 2) Note 3)} Float type auto drain		^{Note 3)} With drain guide	With barb fitting	With bowl guard	AF10	AF20	AF30	AF40	AF40-06	AF50	AF60
	N.C.	N.O.										
Polycarbonate	—	—	—	—	●	—	C2SF-C	—	—			
	●	—	—	—	—	—	AD27-C	—	—			
	—	—	●	—	—	—	C2SF-J	C3SF-J	C4SF-J			
	—	—	—	●	—	—	—	C3SF-W	C4SF-W			
	—	—	●	—	●	—	C2SF-CJ	—	—			
Nylon	—	—	—	—	—	C1SF-6	C2SF-6	C3SF-6	C4SF-6			
	—	—	—	—	●	—	C2SF-6C	—	—			
	●	—	—	—	—	AD17-6	AD27-6	AD37-6	AD47-6			
	—	●	—	—	—	—	—	AD38-6	AD48-6			
	●	—	—	—	●	—	AD27-6C	—	—			
	—	—	●	—	—	—	C2SF-6J	C3SF-6J	C4SF-6J			
	—	—	—	●	—	—	—	C3SF-6W	C4SF-6W			
Metal	—	—	—	—	—	C1SF-2	C2SF-2	C3SF-2	C4SF-2			
	●	—	—	—	—	AD17-2	AD27-2	AD37-2	AD47-2			
	—	●	—	—	—	—	—	AD38-2	AD48-2			
	—	—	●	—	—	—	C2SF-2J	C3SF-2J	C4SF-2J			
Metal bowl with level gauge	—	—	—	—	—	—	—	C3LF-8	C4LF-8			
	●	—	—	—	—	—	—	AD37-8	AD47-8			
	—	●	—	—	—	—	—	AD38-8	AD48-8			
	—	—	●	—	—	—	—	C3LF-8J	C4LF-8J			

Note 1) Assembly of a bracket and 2 mounting screws

Note 2) Minimum operating pressure: N.O. type—0.1 MPa; N.C. type—0.1 MPa (AD17/27) and 0.15 MPa (AD37/47). Please contact SMC for psi and °F unit specifications.

Note 3) Please consult with SMC for details on drain piping to fit NPT or G port sizes.

Note) • Bowl O-ring is included for the AF20 to AF60.

• Bowl assembly for the AF30 to AF60 models comes with a bowl guard (steel band material). (except when the bowl material is metal)

AC

AF□

AR

AL

AW□

A□G

AV

AF800
AF900

Series AF10 to AF60

Flow Characteristics (Representative values)

AF10 M5

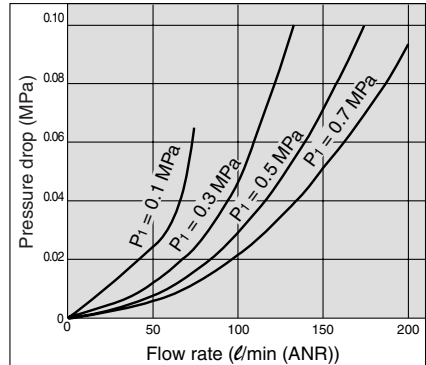

AF20 Rc1/4

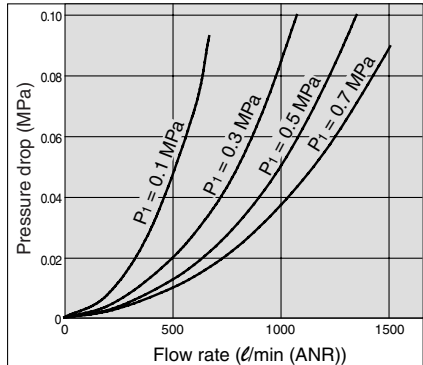

AF30 Rc3/8

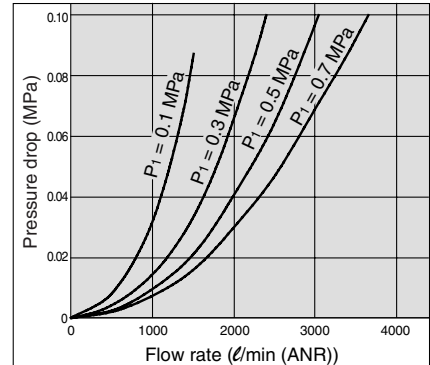

AF40 Rc1/2

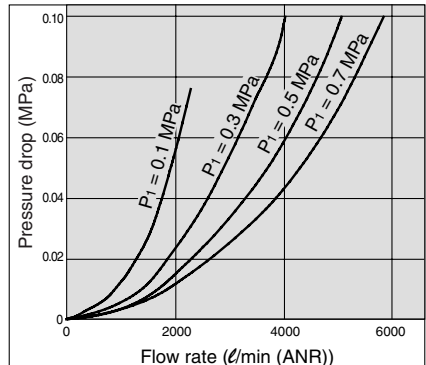

AF40-06 Rc3/4

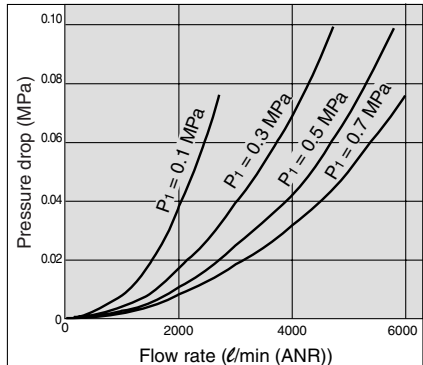

AF50 Rc1

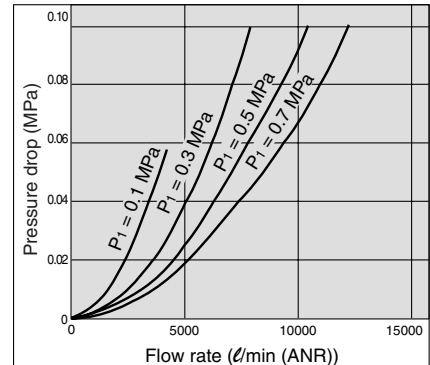

AF60 Rc1

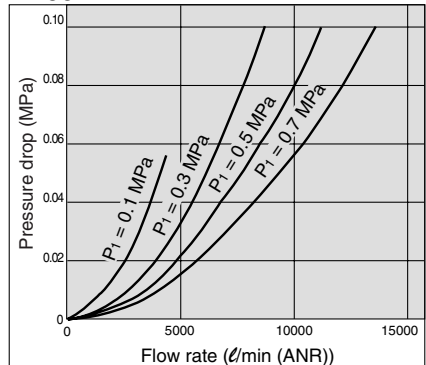

⚠ Specific Product Precautions

- Be sure to read before handling.
- Refer to front matters 42 and 43 for Safety Instructions and pages 287 to 291 for F.R.L. Precautions.

Mounting and Adjustment

⚠ Warning

1. Replace the element every 2 years or when the pressure drop becomes 0.1 MPa, whichever comes first, to prevent damage to the element.

Working Principle: Float Type Auto Drain

N.O. type: AD38, AD48

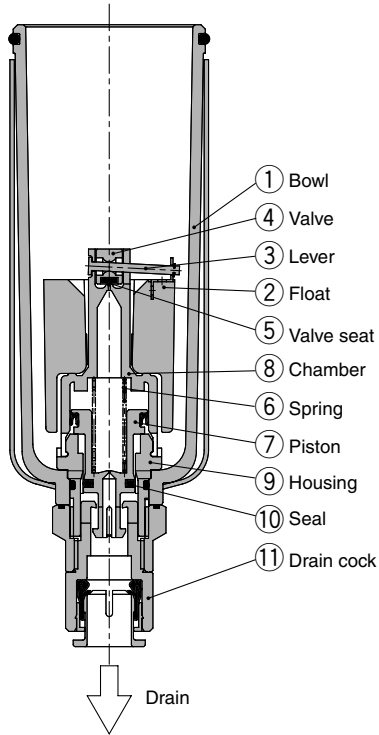

N.C. type: AD37, AD47

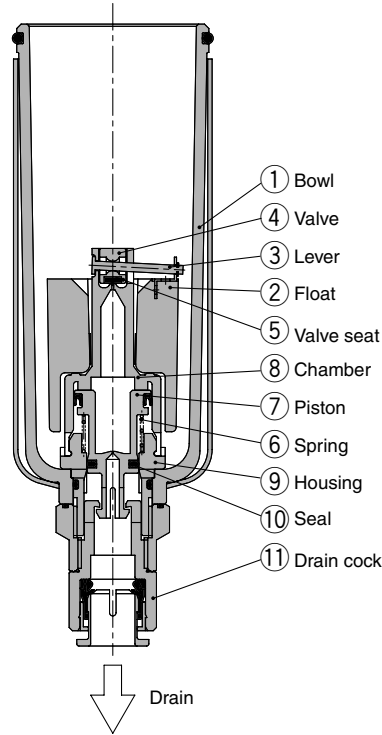

**Compact auto drain
N.C. type: AD17, AD27**

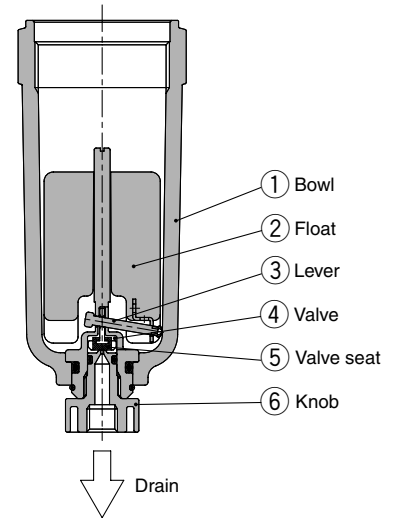

• **When pressure inside the bowl is released:**

When pressure is released from the bowl ①, piston ⑦ is lowered by spring ⑥. The sealing action of seal ⑩ is interrupted, and the outside air flows inside the bowl ① through housing hole ⑨ and drain cock ⑪. Therefore, if there is an accumulation of condensate in the bowl ①, it will drain out through the drain cock.

• **When pressure is applied inside the bowl:**

When pressure exceeds 0.1 MPa, the force of piston ⑦ surpasses the force of spring ⑥, and the piston goes up. This pushes seal ⑩ up so that it creates a seal, and the inside of the bowl ①, is shut off from the outside air.

If there is no accumulation of condensate in the bowl ① at this time, float ② will be pulled down by its own weight, causing valve ④, which is connected to lever ③, to seal valve seat ⑤.

• **When there is an accumulation of condensate in the bowl:**

Float ② rises due to its own buoyancy and pushes open the seal created by the valve seat ⑤.

This allows the pressure inside the bowl ① to enter the chamber ⑧. The result is that the combined pressure inside chamber ⑧ and the force of the spring ⑥ lowers the piston ⑦.

This causes the sealing action of seal ⑩ to be interrupted, and the accumulated condensate in the bowl ① drains out through the drain cock ⑪. Turning drain cock ⑪ manually counterclockwise lowers piston ⑦, which pushes open the seal created by seal ⑩, thus allowing the condensate to drain out.

• **When pressure inside the bowl is released:**

Even when pressure inside the bowl ① is released, spring ⑥ keeps piston ⑦ in its upward position. This keeps the seal created by the seal ⑩ in place; thus, the inside of the bowl ① is shut off from the outside air.

Therefore, even if there is an accumulation of condensate in the bowl ①, it will not drain out.

• **When pressure is applied inside the bowl:**

Even when pressure is applied inside the bowl ①, the combined force of spring ⑥ and the pressure inside the bowl ① keeps piston ⑦ in its upward position.

This maintains the seal created by the seal ⑩ in place; thus, the inside of the bowl ① is shut off from the outside air.

If there is no accumulation of condensate in the bowl ① at this time float ② will be pulled down by its own weight, causing valve ④, which is connected to lever ③, to seal valve seat ⑤.

• **When there is an accumulation of condensate in the bowl:**

Float ② rises due to its own buoyancy and pushes open the seal created by the valve seat ⑤. Pressure passes from the bowl ① to chamber ⑧.

The result is that the pressure inside chamber ⑧ surpasses the force of the spring ⑥ and pushes piston ⑦ downwards.

This causes the sealing action of seal ⑩ to be interrupted and the accumulated condensate in the bowl ① drains out through the drain cock ⑪. Turning drain cock ⑪ manually counterclockwise lowers piston ⑦, which pushes open the seal created by seal ⑩, thus allowing the condensate to drain out.

• **When pressure inside the bowl is released:**

Even when pressure inside the bowl ① is released, the weight of the float ② causes valve ④, which is connected to lever ③, to seal valve seat ⑤. As a result, the inside of the bowl ① is shut off from the outside air.

Therefore, even if there is an accumulation of condensate in the bowl ①, it will not drain out.

• **When pressure is applied inside the bowl:**

Even when pressure is applied inside the bowl ①, the weight of the float ② and the differential pressure that is applied to valve ④ cause valve ④ to seal valve seat ⑤, and the outside air is shut off from the inside of the bowl ①.

• **When the drain is accumulated in the bowl:**

Float ② rises due to its own buoyancy and the seal at valve seat ⑤ is interrupted.

The condensate inside the bowl ① drains out through the knob ⑥.

Turning knob ⑥ manually counterclockwise lowers it and causes the sealing action of valve seat ⑤ to be interrupted, which allows the condensate to drain out.

AC

AF□

AR

AL

AW□

A□G

AV

AF800

AF900

Series AF10 to AF60

Construction

AF10, AF20

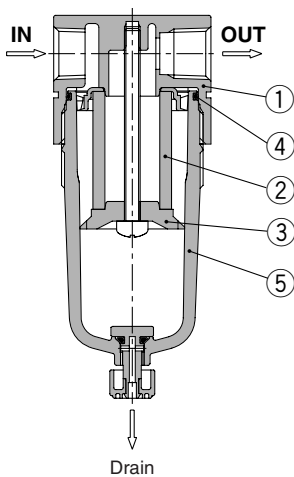

AF30 to AF40-06

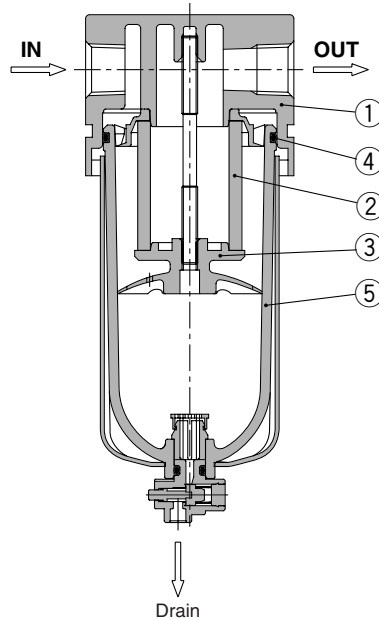

AF50, AF60

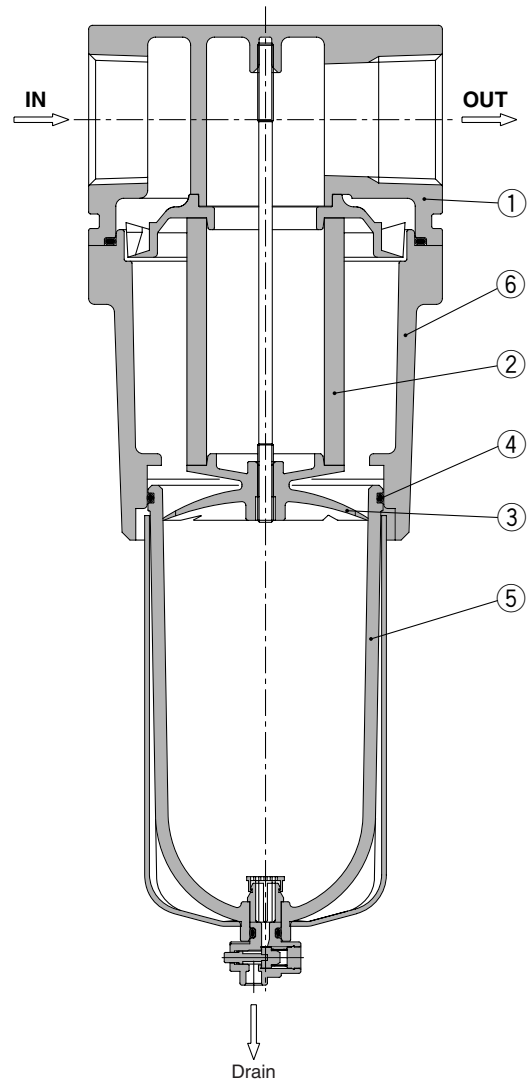

Component Parts

No.	Description	Material	Model	Color
1	Body	Zinc die-cast	AF10	Platinum silver
		Aluminum die-cast	AF20 to AF60	
6	Housing	Aluminum die-cast	AF50, AF60	Platinum silver

Replacement Parts

No.	Description	Material	Part no.						
			AF10	AF20	AF30	AF40	AF40-06	AF50	AF60
2	Filter element	Non-woven fabric	AF10P-060S	AF20P-060S	AF30P-060S	AF40P-060S		AF50P-060S	AF60P-060S
3	Baffle	PBT	AF10P-040S ^{Note 1)}	AF20P-040S	AF30P-040S	AF40P-040S		AF50P-040S	AF60P-040S
4	Bowl O-ring	NBR	C1SFP-260S	C2SFP-260S	C3SFP-260S	C4SFP-260S			
5	Bowl assembly ^{Note 2)}	Polycarbonate	C1SF	C2SF	C3SF ^{Note 3)}	C4SF ^{Note 3)}			

Note 1) The material of the baffle for the AF10 (AF10P-040S) only is polyacetal.

Note 2) Bowl O-ring is included. Please contact SMC regarding the bowl assembly supply for psi and °F unit specifications.

Note 3) Bowl assembly for the AF30 to AF60 models comes with a bowl guard (steel band material).

Dimensions

AF10, AF20

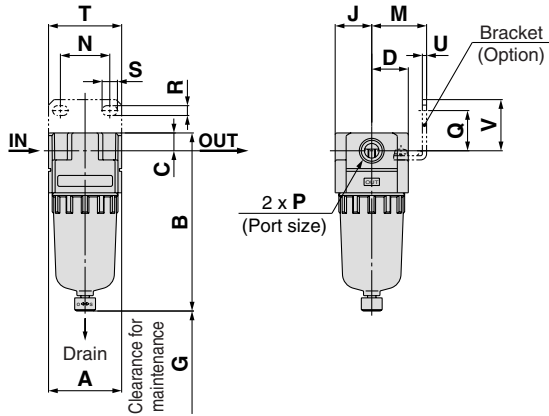

AF50, AF60

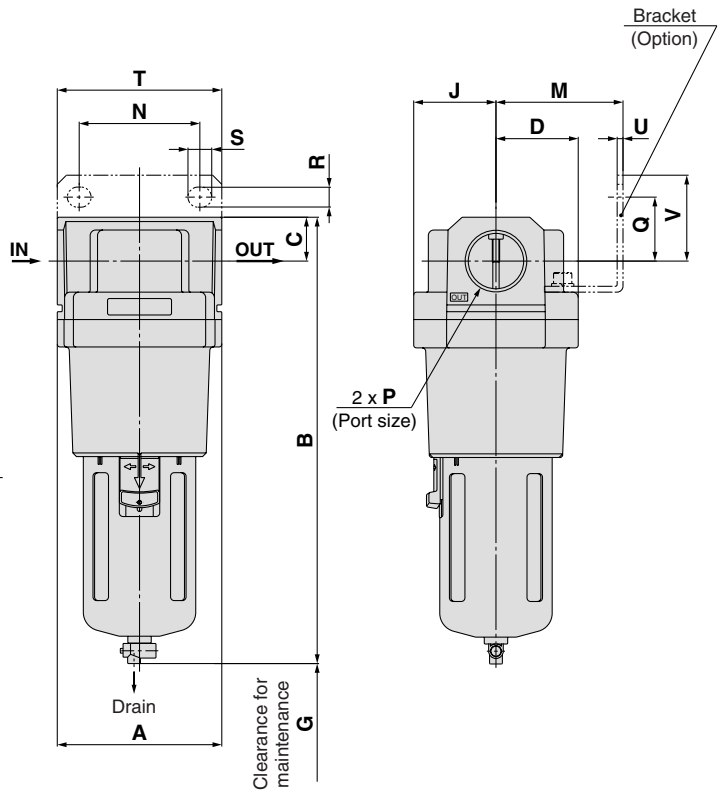

AF30 to AF40-06

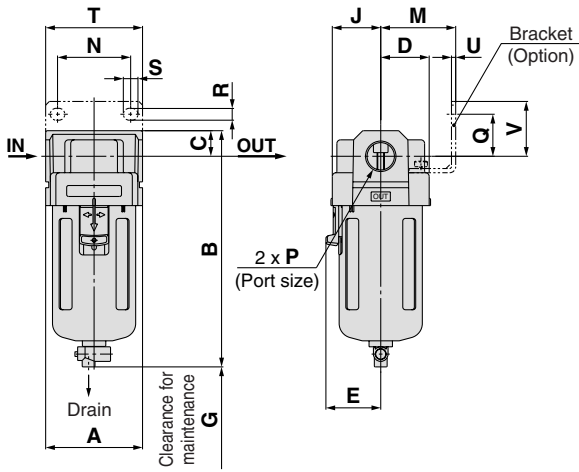

Applicable model	AF10/20		AF20	AF30 to AF60				
Optional/Semi-standard specifications	With auto drain (N.C.)	Metal bowl	With drain guide	With auto drain (N.O./N.C.)	Metal bowl	Metal bowl with level gauge	With drain guide	Drain cock with barb fitting
Dimensions	 M5 x 0.8		 1/8 Width across flats 14	 N.O.: Black N.C.: Gray ø10 one-touch fitting			 1/4 Width across flats 17	 Barb fitting Applicable tubing: T0604

Model	Standard specifications								Optional specifications								
	P	A	B	C	D	E	G	J	M	N	Q	R	S	T	U	V	B
AF10	M5 x 0.8	25	67	7	12.5	—	25	12.5	—	—	—	—	—	—	—	—	85
AF20	1/8, 1/4	40	97	10	20	—	40	20	30	27	22	5.4	8.4	40	2.3	28	115
AF30	1/4, 3/8	53	129	14	26.5	30	50	26.5	41	40	23	6.5	8	53	2.3	30	170
AF40	1/4, 3/8, 1/2	70	165	18	35	38	75	35	50	54	26	8.5	10.5	70	2.3	35	204
AF40-06	3/4	75	169	20	35	38	75	35	50	54	25	8.5	10.5	70	2.3	34	208
AF50	3/4, 1	90	245	24	45	—	20	45	70	66	35	11	13	90	3.2	47	284
AF60	1	95	258	24	47.5	—	20	47.5	70	66	35	11	13	90	3.2	47	297

Model	Semi-standard specifications			
	With barb fitting	With drain guide	Metal bowl	Metal bowl with level gauge
	B	B	B	B
AF10	—	—	66	—
AF20	—	101	97	—
AF30	137	136	142	162
AF40	173	172	178	198
AF40-06	177	176	182	202
AF50	253	252	258	278
AF60	266	265	271	291

AC

AF□

AR

AL

AW□

A□G

AV

AF800
AF900

Air Filter AF10 to AF60

Made to Order Specifications:



Please contact SMC for detailed dimensions, specifications, and lead times.

① Special Temperature Environment

Special materials are used in the manufacturing of seals and resin parts to allow them to withstand various temperature conditions in cold or tropical (hot) climates.

Specifications

Made-to-order no.		-X430	-X440
Environment		Low temperature	High temperature
Ambient temperature (°C)		-30 to 60	-5 to 80
Fluid temperature (°C)		-5 to 60 (with no freezing)	
Material	Rubber parts	Special NBR	FKM
	Main parts	Metal (Aluminum die-cast, etc.)	

Applicable Model

Model	AF30	AF40	AF40-06	AF50	AF60
Port size	1/4, 3/8	1/4, 3/8, 1/2	3/4	3/4, 1	1

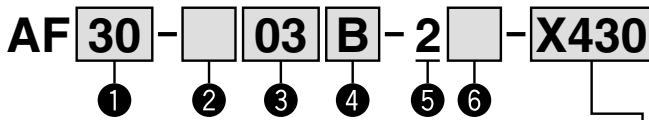

- Semi-standard: Select one each for a to c.
- Semi-standard symbol: When more than one specification is required, indicate in alphanumeric order.
Example) AF30-03B-2R-X430

For high/low temperature

X430	Low temperature
X440	High temperature

	Symbol	Description	① Body size				
			30	40	50	60	
② Thread type	Nil	Rc	●	●	●	●	
	N ^{Note 1)}	NPT	●	●	●	●	
	F ^{Note 2)}	G	●	●	●	●	
+							
③ Port size	02	1/4	●	●	—	—	
	03	3/8	●	●	—	—	
	04	1/2	—	●	—	—	
	06	3/4	—	●	●	—	
	10	1	—	—	●	●	
+							
④ Option (Mounting)	Nil	Without mounting option	●	●	●	●	
	B ^{Note 3)}	With bracket	●	●	●	●	
+							
⑤ Bowl ^{Note 4)}	2	Metal bowl	●	●	●	●	
+							
⑥ Semi-standard	a Drain port	Nil	With drain cock	●	●	●	●
		J ^{Note 5)}	Drain guide 1/4	●	●	●	●
	+						
	b Flow direction	Nil	Flow direction: Left to right	●	●	●	●
		R	Flow direction: Right to left	●	●	●	●
	+						
c Pressure unit	Nil	Name plate and caution plate for bowl in imperial units: MPa	●	●	●	●	
	Z ^{Note 6)}	Name plate and caution plate for bowl in imperial units: psi, °F	○ ^{Note 7)}	○ ^{Note 7)}	○ ^{Note 7)}	○ ^{Note 7)}	

- Note 1) Drain guide is NPT1/4.
 Note 2) Drain guide is G1/4.
 Note 3) A bracket is not assembled and supplied loose at the time of shipment. Including 2 mounting screws
 Note 4) Only metal bowl 2 is available.
 Note 5) Without a valve function
 Note 6) For thread type: NPT. This product is for overseas use only according to the new Measurement Law. (The SI unit type is provided for use in Japan.)
 Note 7) ○: For thread type: NPT only

② High Pressure

Strong materials are used in the manufacturing of air filters intended for high pressure operation.

Specifications

Made-to-order no.	-X425
Proof pressure (MPa)	3.0
Maximum operating pressure (MPa)	2.0
Ambient and fluid temperature (°C)	-5 to 60 (with no freezing)

Applicable Model

Model	AF20	AF30	AF40	AF40-06	AF50	AF60
Port size	1/8, 1/4	1/4, 3/8	1/4, 3/8, 1/2	3/4	3/4, 1	1

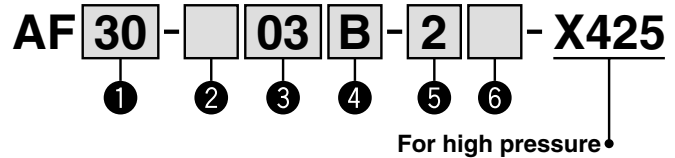

- Semi-standard: Select one each for a to c.
- Semi-standard symbol: When more than one specification is required, indicate in alphanumeric order.
Example) AF30-03B-2R-X425

	Symbol	Description	① Body size				
			20	30	40	50	60
② Thread type	Nil	Rc	●	●	●	●	
	N ^{Note 1)}	NPT	●	●	●	●	
	F ^{Note 2)}	G	●	●	●	●	
+							
③ Port size	01	1/8	●	—	—	—	
	02	1/4	●	●	—	—	
	03	3/8	—	●	—	—	
	04	1/2	—	—	●	—	
	06	3/4	—	—	●	●	
	10	1	—	—	—	●	
+							
④ Option (Mounting)	Nil	Without mounting option	●	●	●	●	
	B ^{Note 3)}	With bracket	●	●	●	●	
+							
⑤ Bowl ^{Note 4)}	2	Metal bowl	●	●	●	●	
	8	Metal bowl with level gauge	—	●	●	●	
+							
⑥ Semi-standard	a Drain port	Nil	With drain cock	●	●	●	●
		J ^{Note 5)}	Drain guide 1/8	●	—	—	—
		J ^{Note 5)}	Drain guide 1/4	—	●	●	●
	+						
	b Flow direction	Nil	Flow direction: Left to right	●	●	●	●
		R	Flow direction: Right to left	●	●	●	●
+							
c Pressure unit	Nil	Name plate and caution plate for bowl in imperial units: MPa	●	●	●	●	
	Z ^{Note 6)}	Name plate and caution plate for bowl in imperial units: psi, °F	○ ^{Note 7)}	○ ^{Note 7)}	○ ^{Note 7)}	○ ^{Note 7)}	

- Note 1) Drain guide is NPT1/8 (applicable to the AF20) and NPT1/4 (applicable to the AF30 to AF60).
 Note 2) Drain guide is G1/8 (applicable to the AF20) and G1/4 (applicable to the AF30 to AF60).
 Note 3) A bracket is not assembled and supplied loose at the time of shipment. Including 2 mounting screws
 Note 4) Only metal bowl 2 and 8 are available.
 Note 5) Without a valve function
 Note 6) For thread type: NPT. This product is for overseas use only according to the new Measurement Law. (The SI unit type is provided for use in Japan.)
 Note 7) ○: For thread type: NPT only

③ Long Bowl

Drain capacity is greater than that of standard models.

Applicable Model/Drain Capacity

Model	AF10	AF20	AF30	AF40	AF40-06	AF50	AF60
Port size	M5	1/8, 1/4	1/4, 3/8	1/4, 3/8, 1/2	3/4	3/4, 1	1
Drain capacity (cm³)	9	19	43	88			

Note) Please consult with SMC for dimensions.

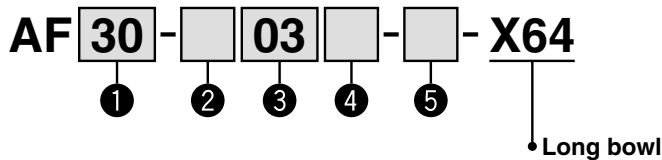

- Semi-standard: Select one each for **a** to **d**.
- Option/Semi-standard symbol: When more than one specification is required, indicate in alphanumeric order.
Example) AF30-03B-2R-X64

		Symbol	Description	①						
				Body size						
				10	20	30	40	50	60	
②	Thread type	Nil	Metric thread (M5)	●	—	—	—	—	—	
		N <small>Note 1)</small>	Rc	—	●	●	●	●	●	
		F <small>Note 2)</small>	NPT	—	●	●	●	●	●	
			G	—	●	●	●	●	●	
		+								
③	Port size	M5	M5	●	—	—	—	—	—	
		01	1/8	—	●	—	—	—	—	
		02	1/4	—	●	●	—	—	—	
		03	3/8	—	—	●	●	—	—	
		04	1/2	—	—	—	●	—	—	
		06	3/4	—	—	—	—	●	●	
		10	1	—	—	—	—	●	●	
		+								
④	Option (Mounting)	Nil	Without mounting option	●	●	●	●	●	●	
		B <small>Note 3)</small>	With bracket	—	●	●	●	●	●	
		+								
⑤ Semi-standard	a	Bowl <small>Note 4)</small>	Nil	Polycarbonate bowl	●	●	●	●	●	●
			2	Metal bowl	●	●	●	●	●	●
			6	Nylon bowl	●	●	●	●	●	●
			C	With bowl guard	—	●	—	—	—	—
			6C	Nylon bowl with bowl guard	—	●	—	—	—	—
			+							
	b	Drain port	Nil	With drain cock	●	●	●	●	●	●
			J <small>Note 5)</small>	Drain guide 1/8	—	●	—	—	—	—
			W <small>Note 6)</small>	Drain cock with barb fitting: For ø6 x ø4 nylon tube	—	—	●	●	●	●
			+							
	c	Flow direction	Nil	Flow direction: Left to right	●	●	●	●	●	●
			R	Flow direction: Right to left	●	●	●	●	●	●
			+							
	d	Pressure unit	Nil	Name plate and caution plate for bowl in imperial units: MPa	●	●	●	●	●	●
			Z <small>Note 7)</small>	Name plate and caution plate for bowl in imperial units: psi, °F	○ <small>Note 8)</small>	○ <small>Note 8)</small>	○ <small>Note 8)</small>	○ <small>Note 8)</small>	○ <small>Note 8)</small>	○ <small>Note 8)</small>

Note 1) Drain guide is NPT1/8 (applicable to the AF20) and NPT1/4 (applicable to the AF30 to AF60).
 Note 2) Drain guide is G1/8 (applicable to the AF20) and G1/4 (applicable to the AF30 to AF60).
 Note 3) A bracket is not assembled and supplied loose at the time of shipment. Including 2 mounting screws

Note 4) Refer to Chemical Data on page 287 when selecting a case material.
 Note 5) Without a valve function
 Note 6) Metal bowl: The combination with 2 is not possible.
 Note 7) For thread type: M5, NPT. This product is for overseas use only according to the new Measurement Law. (The SI unit type is provided for use in Japan.)
 Note 8) ○: For thread type: M5, NPT only

AC

AF□

AR

AL

AW□

A□G

AV

AF800

AF900

Air Filter AF30 to AF60 Made to Order Specifications:



Please contact SMC for detailed dimensions, specifications, and lead times.

④ With Element Service Indicator

Clogging status of elements can be checked visually.

Applicable Model

Model	AF30	AF40	AF40-06	AF50	AF60
Port size	1/4, 3/8	1/4, 3/8, 1/2	3/4	3/4, 1	1

AF **30** - **03** - **04** - **03** - **04** - **X2141**

① ② ③ ④ ⑤

• With element service indicator

A special body type is required to mount the clogging checker. It cannot be mounted on a standard body.

- Option/Semi-standard: Select one each for a to f.
- Option/Semi-standard symbol: When more than one specification is required, indicate in alphanumeric order.
Example) AF30-03BD-2R-X2141

	Symbol	Description	① Body size				
			30	40	50	60	
② Thread type	Nil	Rc	●	●	●	●	
	N ^{Note 1)}	NPT	●	●	●	●	
	F ^{Note 2)}	G	●	●	●	●	
+							
③ Port size	02	1/4	●	●	—	—	
	03	3/8	●	●	—	—	
	04	1/2	—	●	—	—	
	06	3/4	—	●	●	—	
	10	1	—	—	●	●	
+							
④ Option	a Mounting	Nil	Without mounting option				
		B ^{Note 3)}	With bracket				
+							
④ Option	b Float type auto drain	Nil	Without auto drain				
		C	Float type auto drain (N.C.)				
		D	Float type auto drain (N.O.)				
+							
⑤ Semi-standard	c Bowl ^{Note 4)}	Nil	Polycarbonate bowl				
		2	Metal bowl				
		6	Nylon bowl				
		8	Metal bowl with level gauge				
	+						
	d Drain port ^{Note 5)}	Nil	With drain cock				
		J ^{Note 6)}	Drain guide 1/4				
		W ^{Note 7)}	Drain cock with barb fitting: For ø6 x ø4 nylon tube				
	+						
	e Flow direction	Nil	Flow direction: Left to right				
R		Flow direction: Right to left					
+							
f Pressure unit	Nil	Name plate and caution plate for bowl in imperial units: MPa					
	Z ^{Note 8)}	Name plate and caution plate for bowl in imperial units: psi, °F					
			○ ^{Note 9)}	○ ^{Note 9)}	○ ^{Note 9)}	○ ^{Note 9)}	

Note 1) Drain guide is NPT1/4.

The auto drain port comes with ø3/8" One-touch fitting.

Note 2) Drain guide is G1/4.

Note 3) Option B is not assembled and supplied loose at the time of shipment.
Including 2 mounting screws

Note 4) Refer to Chemical Data on page 287 when selecting a case material.

Note 5) Float type auto drain: The combination of C and D is not possible.

Note 6) Without a valve function

Note 7) Metal bowl: The combination of 2 and 8 is not possible.

Note 8) For thread type: NPT. This product is for overseas use only according to the new Measurement Law. (The SI unit type is provided for use in Japan.)

Note 9) ○: For thread type: NPT only

AC

AF□

AR

AL

AW□

A□G

AV

AF800
AF900

Mist Separator

AFM20 to AFM40

Micro Mist Separator

AFD20 to AFD40

JIS Symbol
Mist Separator

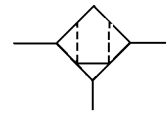

Micro Mist Separator

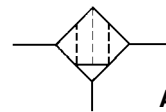

AFM20, AFD20 AFM40, AFD40

- Series AFM Nominal filtration rating: 0.3 μm
- Series AFD Nominal filtration rating: 0.01 μm

How to Order

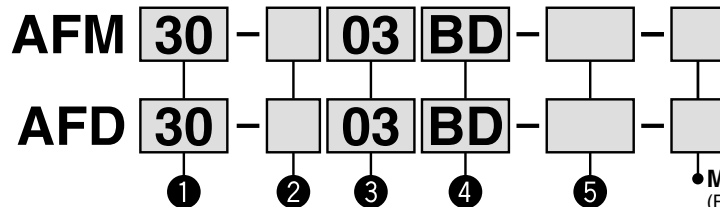

- Option/Semi-standard: Select one each for a to f.
- Option/Semi-standard symbol: When more than one specification is required, indicate in alphanumeric order.
Example) AFM30-03BD-2R

• Made to Order
(Refer to pages 343 and 344 for details.)

	Symbol	Description	①				
			Body size				
			20	30	40		
②	Thread type	Nil	Rc	●	●	●	
		N ^{Note 1)}	NPT	●	●	●	
		F ^{Note 2)}	G	●	●	●	
+							
③	Port size	01	1/8	●	—	—	
		02	1/4	●	●	●	
		03	3/8	—	●	●	
		04	1/2	—	—	●	
		06	3/4	—	—	●	
+							
④	a	Mounting	Nil	Without mounting option	●	●	●
			B ^{Note 3)}	With bracket	●	●	●
+							
④	b	Float type auto drain ^{Note 4)}	Nil	Without auto drain	●	●	●
			C	Float type auto drain (N.C.)	●	●	●
			D	Float type auto drain (N.O.)	—	●	●
+							
⑤	c	Bowl ^{Note 5)}	Nil	Polycarbonate bowl	●	●	●
			2	Metal bowl	●	●	●
			6	Nylon bowl	●	●	●
			8	Metal bowl with level gauge	—	●	●
			C	With bowl guard	●	—	—
			6C	Nylon bowl with bowl guard	●	—	—
	+						
	d	Drain port	Nil	With drain cock	●	●	●
			J ^{Note 6)}	Drain guide 1/8	●	—	—
			W ^{Note 7)}	Drain cock with barb fitting: For ø6 x ø4 nylon tube	—	●	●
+							
e	Flow direction	Nil	Flow direction: Left to right	●	●	●	
		R	Flow direction: Right to left	●	●	●	
+							
f	Pressure unit	Nil	Name plate and caution plate for bowl in imperial units: MPa	●	●	●	
		Z ^{Note 8)}	Name plate and caution plate for bowl in imperial units: psi, °F	○ ^{Note 9)}	○ ^{Note 9)}	○ ^{Note 9)}	

Note 1) Drain guide is NPT1/8 (applicable to the AFM20, AFD20) and NPT1/4 (applicable to the AFM30/40, AFD30/40).

The auto drain port comes with ø3/8" one-touch fitting (applicable to the AFM30/40, AFD30/40).

Note 2) Drain guide is G1/8 (applicable to the AFM20, AFD20) and G1/4 (applicable to the AFM30/40, AFD30/40).

Note 3) A bracket is not assembled and supplied loose at the time of shipment. Including 2 mounting screws

Note 4) Float type auto drain: The combination of C and D is not possible.

Note 5) Refer to Chemical Data on page 287 when selecting a case material.

Note 6) Without a valve function

Note 7) Metal bowl: The combination of 2 and 8 is not possible.

Note 8) For thread type: NPT. This product is for overseas use only according to the new Measurement Law. (The SI unit type is provided for use in Japan.)

Note 9) ○: For thread type: NPT only

Mist Separator *Series AFM20 to AFM40* Micro Mist Separator *Series AFD20 to AFD40*

Standard Specifications

Model		AFM20 AFD20	AFM30 AFD30	AFM40 AFD40	AFM40-06 AFD40-06
Port size		1/8, 1/4	1/4, 3/8	1/4, 3/8, 1/2	3/4
Fluid		Air			
Ambient and fluid temperature		-5 to 60°C (with no freezing)			
Proof pressure		1.5 MPa			
Maximum operating pressure		1.0 MPa			
Minimum operating pressure		0.05 MPa			
Nominal filtration rating	AFM20 to AFM40-06	0.3 μm (99.9% filtered particle size)			
	AFD20 to AFD40-06	0.01 μm (99.9% filtered particle size)			
Outlet side oil mist concentration	AFM20 to AFM40-06	Max. 1.0 mg/m ³ (ANR) (≈ 0.8 ppm) ^{Note 2) Note 3)}			
	AFD20 to AFD40-06	Max. 0.1 mg/m ³ (ANR) (Before saturated with oil 0.01 mg/m ³ (ANR) or less ≈ 0.008 ppm) ^{Note 2) Note 3)}			
Rated flow (ℓ/min (ANR)) ^{Note 1)}	AFM20 to AFM40-06	200	450	1100	
	AFD20 to AFD40-06	120	240	600	
Drain capacity (cm³)		8	25	45	
Bowl material		Polycarbonate			
Bowl guard		Semi-standard	Standard		
Mass (kg)		0.10	0.22	0.44	0.49

Note 1) Conditions: Inlet pressure: 0.7 MPa; The rated flow varies depending on the inlet pressure. Keep the air flow within the rated flow to prevent an outflow of lubricant to the outlet side.

Note 2) When the compressor oil mist discharge concentration is 30 mg/m³ (ANR).

Note 3) Bowl O-ring and other O-rings are slightly lubricated.

Options/Part No.

Optional specifications		Model			
		AFM20 AFD20	AFM30 AFD30	AFM40 AFD40	AFM40-06 AFD40-06
Bracket assembly ^{Note 1)}		AF20P-050AS	AF30P-050AS	AF40P-050AS	AF40P-070AS
Float type auto drain ^{Note 2) Note 3)}	N.C.	AD27	AD37	AD47	
	N.O.	—	AD38	AD48	

Semi-standard/Bowl Assembly Part No.

Semi-standard specifications						Model			
Bowl material	Float type auto drain ^{Note 2) Note 3)}		With drain guide ^{Note 3)}	With barb fitting	With bowl guard	AFM20 AFD20	AFM30 AFD30	AFM40 AFD40	AFM40-06 AFD40-06
	N.C.	N.O.							
Polycarbonate	—	—	—	—	●	C2SF-C	—	—	
	●	—	—	—	●	AD27-C	—	—	
	—	—	●	—	—	C2SF-J	C3SF-J	C4SF-J	
	—	—	—	●	—	—	C3SF-W	C4SF-W	
	—	—	●	—	●	C2SF-CJ	—	—	
Nylon	—	—	—	—	—	C2SF-6	C3SF-6	C4SF-6	
	—	—	—	—	●	C2SF-6C	—	—	
	●	—	—	—	—	AD27-6	AD37-6	AD47-6	
	—	●	—	—	—	—	AD38-6	AD48-6	
	●	—	—	—	●	AD27-6C	—	—	
	—	—	●	—	—	C2SF-6J	C3SF-6J	C4SF-6J	
	—	—	—	●	—	—	C3SF-6W	C4SF-6W	
	—	—	●	—	●	C2SF-6CJ	—	—	
Metal	—	—	—	—	—	C2SF-2	C3SF-2	C4SF-2	
	●	—	—	—	—	AD27-2	AD37-2	AD47-2	
	—	●	—	—	—	—	AD38-2	AD48-2	
	—	—	●	—	—	C2SF-2J	C3SF-2J	C4SF-2J	
Metal bowl with level gauge	—	—	—	—	—	—	C3LF-8	C4LF-8	
	●	—	—	—	—	—	AD37-8	AD47-8	
	—	●	—	—	—	—	AD38-8	AD48-8	
	—	—	●	—	—	—	C3LF-8J	C4LF-8J	

Note 1) Assembly of a bracket and 2 mounting screws

Note 2) Minimum operating pressure: N.O. type—0.1 MPa; N.C. type—0.1 MPa (AD27) and 0.15 MPa (AD37/47).

Please consult with SMC separately for psi and °F unit display specifications.

Note 3) Please consult with SMC for details on drain piping to fit NPT or G port sizes.

Note) • Bowl O-ring is included.

• Bowl assembly for the AFM30 to AFM40-06 models and AFD30 to AFD40-06 models comes with a bowl guard (steel band material). (except when the bowl material is metal)

Series AFM20 to AFM40

Series AFD20 to AFD40

Flow Characteristics (Representative values)

— : When saturated with oil
 - - - : Initial state

AFM20

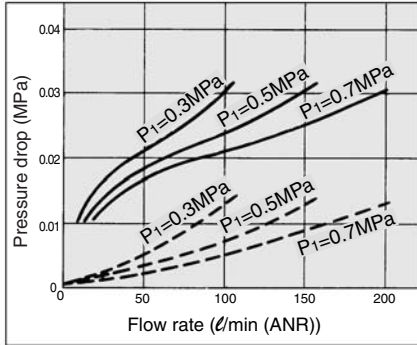

AFM30

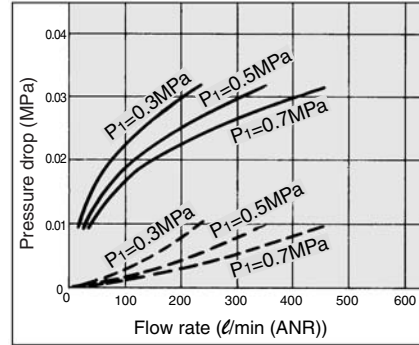

AFM40

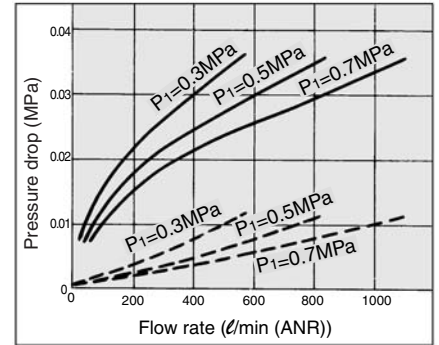

AFD20

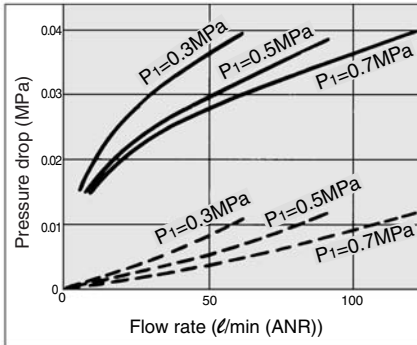

AFD30

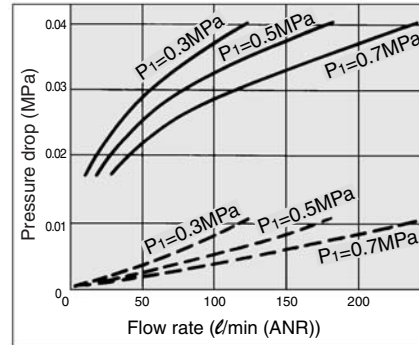

AFD40

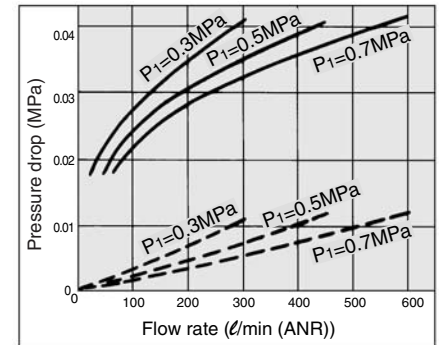

⚠ Specific Product Precautions

Be sure to read before handling.

Refer to front matters 42 and 43 for Safety Instructions and pages 287 to 291 for F.R.L. Precautions.

Air Supply

⚠ Caution

1. Install an air filter (AF series) as a pre-filter on the inlet side of the mist separator to prevent premature clogging.
2. Install a mist separator (AFM series) as a pre-filter on the inlet side of the micro mist separator to prevent premature clogging.
3. Do not install on the inlet side of the dryer as this can cause premature clogging of the element.

Maintenance

⚠ Warning

1. Replace the element every 2 years or when the pressure drop becomes 0.1 MPa, whichever comes first, to prevent damage to the element.

Design

⚠ Caution

1. Design the system so that the mist separator is installed in a pulsation-free location. The difference between internal and external pressure inside the element should be kept within 0.1 MPa, as exceeding this value could cause damage.

Selection

⚠ Caution

1. Do not allow air flow that exceeds the rated flow. If the air flow is allowed outside the range of the rated flow even momentarily, drainage and lubricant may splash at the outlet side or cause damage to the component.
2. Do not use in a low pressure application (such as a blower). F.R.L. unit has its own minimum operating pressure depending on the equipment and is designed specifically to function with compressed air. If used below the minimum operating pressure, a loss of performance and malfunction can occur. Please contact SMC if an application under such conditions cannot be avoided.

Mist Separator *Series AFM20 to AFM40* Micro Mist Separator *Series AFD20 to AFD40*

Construction

**AFM20
AFD20**

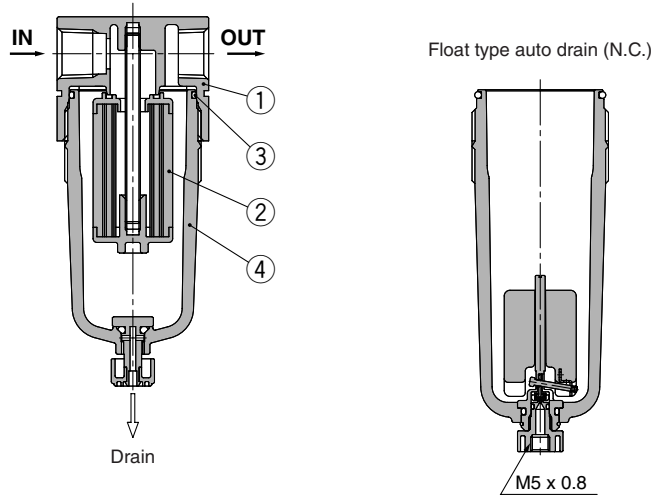

**AFM30 to AFM40-06
AFD30 to AFD40-06**

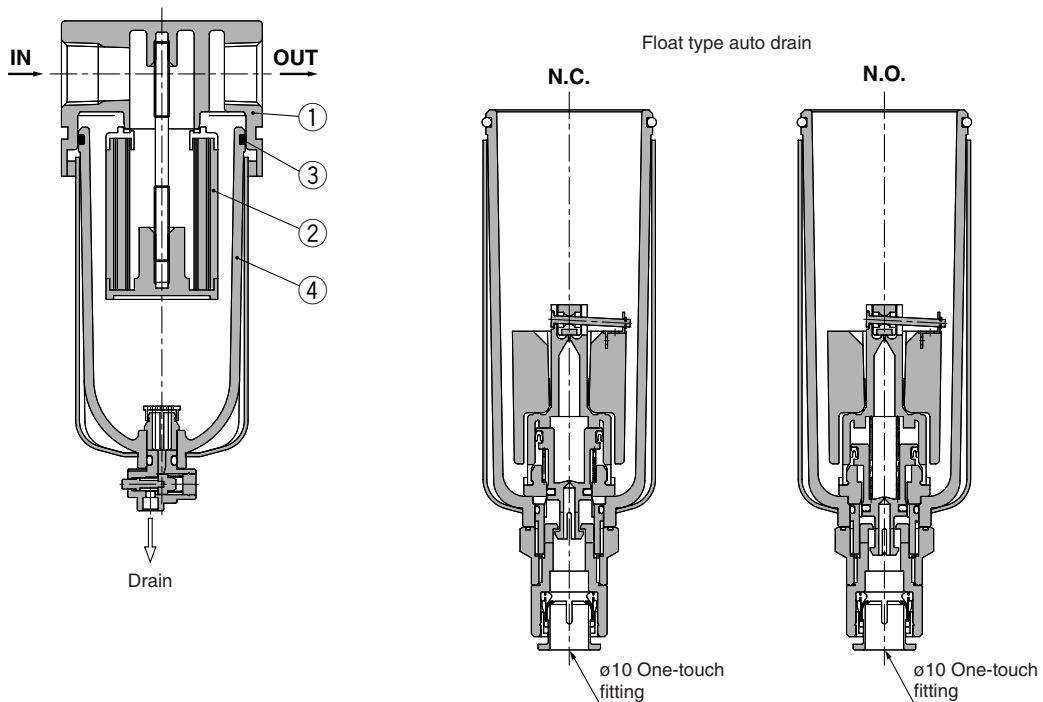

Component Parts

No.	Description	Material	Model	Color
1	Body	Aluminum die-cast	AFM20 to AFM40-06 AFD20 to AFD40-06	Platinum silver

Replacement Parts

No.	Description	Material	Part no.			
			AFM20 AFD20	AFM30 AFD30	AFM40 AFD40	AFM40-06 AFD40-06
2	Element assembly	AFM20 to 40	AFM20P-060AS	AFM30P-060AS	AFM40P-060AS	
		AFD20 to 40	AFD20P-060AS	AFD30P-060AS	AFD40P-060AS	
3	Bowl O-ring	NBR	C2SFP-260S	C3SFP-260S	C4SFP-260S	
4	Bowl assembly ^{Note 1)}	Polycarbonate	C2SF	C3SF ^{Note 2)}	C4SF ^{Note 2)}	

Note 1) Bowl O-ring is included. Please contact SMC regarding the bowl assembly supply for psi and °F unit specifications.

Note 2) Bowl assembly for the AFM30 to AFM40-06 models and the AFD30 to AFD40-06 models comes with a bowl guard (steel band material).

Series AFM20 to AFM40

Series AFD20 to AFD40

Dimensions

AFM20
AFD20

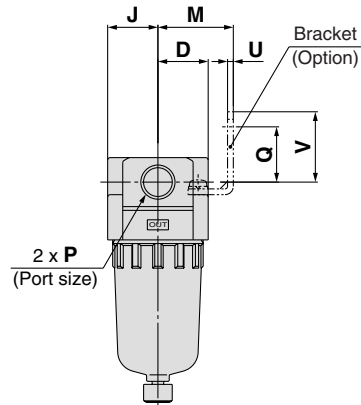
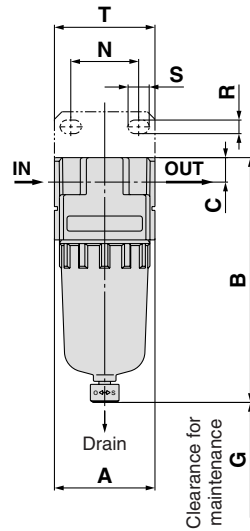

AFM30 to AFM40-06
AFD30 to AFD40-06

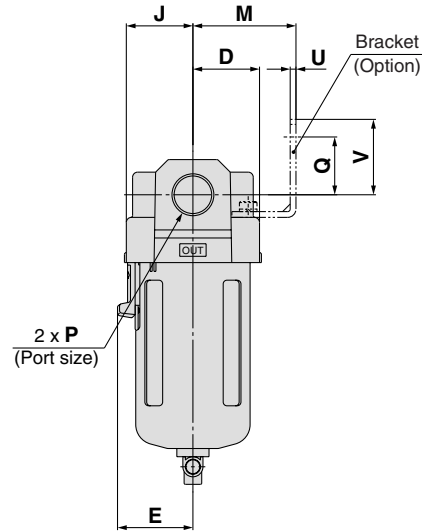
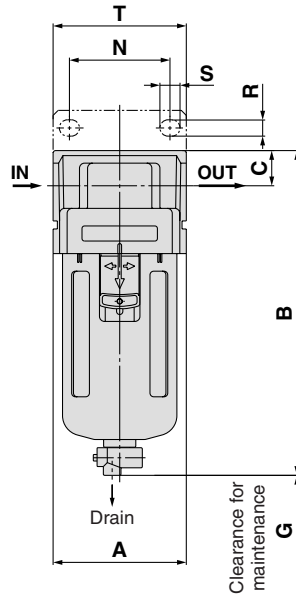

Applicable model Optional/Semi-standard specifications	AFM20, AFD20			AFM30 to AFM40-06, AFD30 to AFD40-06				
	With auto drain (N.C.)	Metal bowl	With drain guide	With auto drain (N.O./N.C.)	Metal bowl	Metal bowl with level gauge	With drain guide	Drain cock with barb fitting
Dimensions								

Model	Standard specifications							Optional specifications									
	P	A	B	C	D	E	G	J	M	N	Q	R	S	T	U	V	With auto drain
AFM20/AFD20	1/8, 1/4	40	97	10	20	—	40	20	30	27	22	5.4	8.4	40	2.3	28	115
AFM30/AFD30	1/4, 3/8	53	129	14	26.5	30	50	26.5	41	40	23	6.5	8	53	2.3	30	170
AFM40/AFD40	1/4, 3/8, 1/2	70	165	18	35	38	75	35	50	54	26	8.5	10.5	70	2.3	35	204
AFM40-06/AFD40-06	3/4	75	169	20	35	38	75	35	50	54	25	8.5	10.5	70	2.3	34	208

Model	Semi-standard specifications			
	With barb fitting	With drain guide	Metal bowl	Metal bowl with level gauge
	B	B	B	B
AFM20/AFD20	—	101	97	—
AFM30/AFD30	137	136	142	162
AFM40/AFD40	173	172	178	198
AFM40-06/AFD40-06	177	176	182	202

Mist Separator *AFM20 to AFM40* Micro Mist Separator *AFD20 to AFD40* Made to Order Specifications:



Please contact SMC for detailed dimensions, specifications, and lead times.

① Long Bowl

Drain capacity is greater than that of standard models.

Applicable Model/Drain Capacity

Model	AFM20, AFD20	AFM30, AFD30	AFM40, AFD40	AFM40-06, AFD40-06
Port size	1/8, 1/4	1/4, 3/8	1/4, 3/8, 1/2	3/4
Drain capacity (cm ³)	19	43	88	

Note) Please consult with SMC for dimensions.

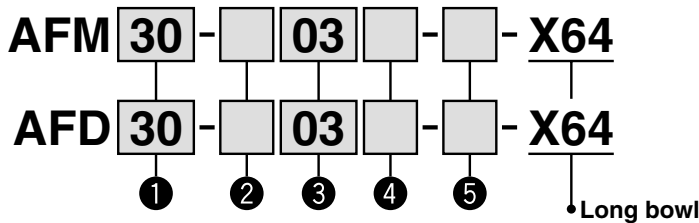

- Semi-standard: Select one each for **a** to **d**.
- Option/Semi-standard symbol: When more than one specification is required, indicate in alphanumeric order.
Example) AFM30-03B-2R-X64

		Symbol	Description	① Body size			
				20	30	40	
②	Thread type	Nil	Rc	●	●	●	
		N ^{Note 1)}	NPT	●	●	●	
		F ^{Note 2)}	G	●	●	●	
+							
③	Port size	01	1/8	●	—	—	
		02	1/4	●	●	●	
		03	3/8	—	●	●	
		04	1/2	—	—	●	
		06	3/4	—	—	●	
+							
④	Option (Mounting)	Nil	Without mounting option	●	●	●	
		B ^{Note 3)}	With bracket	●	●	●	
+							
⑤	a	Bowl ^{Note 4)}	Nil	Polycarbonate bowl	●	●	●
			2	Metal bowl	●	●	●
			6	Nylon bowl	●	●	●
			C	With bowl guard	●	—	—
			6C	Nylon bowl with bowl guard	●	—	—
	+						
	b	Drain port	Nil	With drain cock	●	●	●
			J ^{Note 5)}	Drain guide 1/8	●	—	—
			W ^{Note 6)}	Drain cock with barb fitting: For ø6 x ø4 nylon tube	—	●	●
	+						
	c	Flow direction	Nil	Flow direction: Left to right	●	●	●
			R	Flow direction: Right to left	●	●	●
+							
d	Pressure unit	Nil	Name plate and caution plate for bowl in imperial units: MPa	●	●	●	
		Z ^{Note 7)}	Name plate and caution plate for bowl in imperial units: psi, °F	○ ^{Note 8)}	○ ^{Note 8)}	○ ^{Note 8)}	

Note 1) Drain guide is NPT1/8 (applicable to the AFM20, AFD20) and NPT1/4 (applicable to the AFM30/40, AFD30/40).

Note 2) Drain guide is G1/8 (applicable to the AFM20, AFD20) and G1/4 (applicable to the AFM30/40, AFD30/40).

Note 3) A bracket is not assembled and supplied loose at the time of shipment. Including 2 mounting screws

Note 4) Refer to Chemical Data on page 287 when selecting a case material.

Note 5) Without a valve function

Note 6) Metal bowl: The combination with 2 is not possible.

Note 7) For thread type: NPT. This product is for overseas use only according to the new Measurement Law. (The SI unit type is provided for use in Japan.)

Note 8) ○: For thread type: NPT only

AC

AF□

AR

AL

AW□

A□G

AV

AF800
AF900

Mist Separator *AFM30 to AFM40* Micro Mist Separator *AFD30 to AFD40* Made to Order Specifications:



Please contact SMC for detailed dimensions, specifications, and lead times.

② With Element Service Indicator

Clogging status of elements can be checked visually.

Applicable Model

Model	AFM30, AFD30	AFM40, AFD40	AFM40-06, AFD40-06
Port size	1/4, 3/8	1/4, 3/8, 1/2	3/4

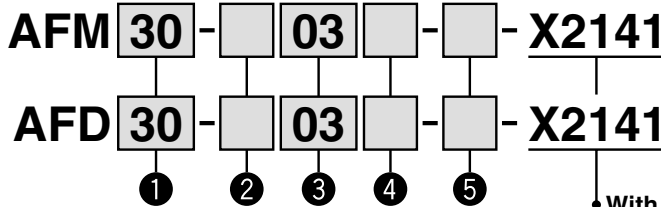

A special body type is required to mount the clogging checker. It cannot be mounted on a standard body.

- Option/Semi-standard: Select one each for a to f.
- Option/Semi-standard symbol: When more than one specification is required, indicate in alphanumeric order.
Example) AF30-03BD-2R-X2141

		Symbol	Description	①	
				Body size	
				30	40
②	Thread type	Nil	Rc	●	●
		N ^{Note 1)}	NPT	●	●
		F ^{Note 2)}	G	●	●
		+			
③	Port size	02	1/4	●	●
		03	3/8	●	●
		04	1/2	—	●
		06	3/4	—	●
		+			
④	a	Nil	Without mounting option	●	●
		B ^{Note 3)}	With bracket	●	●
		+			
④	b	Nil	Without auto drain	●	●
		C	Float type auto drain (N.C.)	●	●
		D	Float type auto drain (N.O.)	●	●
		+			
⑤	c	Nil	Polycarbonate bowl	●	●
		2	Metal bowl	●	●
		6	Nylon bowl	●	●
		8	Metal bowl with level gauge	●	●
		+			
⑤	d	Nil	With drain cock	●	●
		J ^{Note 6)}	Drain guide 1/4	●	●
		W ^{Note 7)}	Drain cock with barb fitting: For ø6 x ø4 nylon tube	●	●
		+			
⑤	e	Nil	Flow direction: Left to right	●	●
		R	Flow direction: Right to left	●	●
		+			
⑤	f	Nil	Name plate and caution plate for bowl in imperial units: MPa	●	●
		Z ^{Note 8)}	Name plate and caution plate for bowl in imperial units: psi, °F	○ ^{Note 9)}	○ ^{Note 9)}

Note 1) Drain guide is NPT1/4.

The auto drain port comes with ø3/8" one-touch fitting.

Note 2) Drain guide is G1/4.

Note 3) Option B is not assembled and supplied loose at the time of shipment.
Including 2 mounting screws

Note 4) Refer to Chemical Data on page 287 when selecting a case material.

Note 5) Float type auto drain: The combination of C and D is not possible.



Note 6) Without a valve function

Note 7) Metal bowl: The combination between 2 and 8 is not possible.

Note 8) For thread type: NPT. This product is for overseas use only according to the new Measurement Law. (The SI unit type is provided for use in Japan.)

Note 9) ○: For thread type: NPT only

Modular Type Regulators *Series AR*

Regulator Series AR	Model	Port size	Options
 <p data-bbox="169 965 496 987">Pages 346 through to 355</p>	AR10	M5 x 0.8	Bracket Square embedded type pressure gauge (except the AR10) Round type pressure gauge Digital pressure switch (except the AR10) Panel mount
	AR20	1/8, 1/4	
	AR25	1/4, 3/8	
	AR30	1/4, 3/8	
	AR40	1/4, 3/8, 1/2	
	AR40-06	3/4	
	AR50	3/4, 1	
	AR60	1	
Regulator with Backflow Function Series AR□K	AR20K	1/8, 1/4	Digital pressure switch (except the AR10) Panel mount
 <p data-bbox="169 1384 496 1406">Pages 346 through to 355</p>	AR25K	1/4, 3/8	
	AR30K	1/4, 3/8	
	AR40K	1/4, 3/8, 1/2	
	AR40K-06	3/4	
	AR50K	3/4, 1	
	AR60K	1	

AC

AF□

AR

AL

AW□

A□G

AV

AF800
AF900

Regulator

AR10 to AR60

Regulator with Backflow Function

AR20K to AR60K

JIS Symbol
Regulator

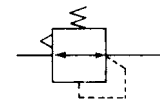

Regulator with
Backflow Function

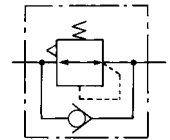

- With the backflow function it incorporates a mechanism to exhaust the air pressure in the outlet side reliably and quickly.

Example 1)

When the pressure in the rear and the front of the cylinder differs:

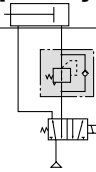

Example 2)

When the air supply is cut off and releasing the inlet pressure to the atmosphere, the residual pressure release of the outlet side can be ensured for a safety purpose.

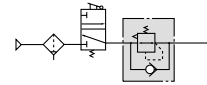

How to Order

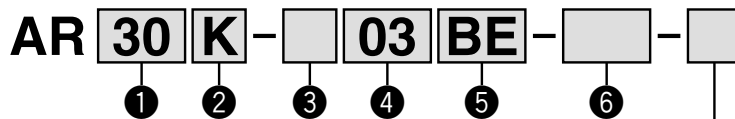

Made to Order

(Refer to pages 354 and 355 for details.)

- Option/Semi-standard: Select one each for a to g.
- Option/Semi-standard symbol: When more than one specification is required, indicate in alphanumeric order.
Example) AR30K-03BE-1NR

		Symbol	Description	① Body size							
				10	20	25	30	40	50	60	
②	With backflow function	Nil	Without backflow function	●	●	●	●	●	●	●	●
		K ^{Note 1)}	With backflow function	—	●	●	●	●	●	●	●
+											
③	Thread type	Nil	Metric thread (M5)	●	—	—	—	—	—	—	—
			Rc	—	●	●	●	●	●	●	●
		N	NPT	—	●	●	●	●	●	●	●
		F	G	—	●	●	●	●	●	●	●
+											
④	Port size	M5	M5	●	—	—	—	—	—	—	—
		01	1/8	—	●	—	—	—	—	—	—
		02	1/4	—	●	●	●	●	—	—	—
		03	3/8	—	—	●	●	●	—	—	—
		04	1/2	—	—	—	—	●	—	—	—
		06	3/4	—	—	—	—	●	●	—	—
	10	1	—	—	—	—	—	●	●	●	
+											
⑤ Option ^{Note 2)}	a	Mounting	Nil	Without mounting option	●	●	●	●	●	●	●
			B ^{Note 3)}	With bracket	●	●	●	●	●	●	●
			H	With set nut (for panel fitting)	●	●	●	●	●	—	—
	+										
	b	Pressure gauge	Nil	Without pressure gauge	●	●	●	●	●	●	●
			E	Square embedded type pressure gauge (with limit indicator)	—	●	●	●	●	●	●
			G	Round type pressure gauge (without limit indicator)	●	—	—	—	—	—	—
				Round type pressure gauge (with limit indicator)	—	●	●	●	●	●	●
		Digital pressure switch	M	Round type pressure gauge (with color zone)	—	●	●	●	●	●	●
			E1 ^{Note 4)}	Output: NPN output / Electrical entry: Wiring bottom entry	—	●	●	●	●	●	●
	E2 ^{Note 4)}		Output: NPN output / Electrical entry: Wiring top entry	—	●	●	●	●	●	●	
	E3 ^{Note 4)}		Output: PNP output / Electrical entry: Wiring bottom entry	—	●	●	●	●	●	●	
	E4 ^{Note 4)}	Output: PNP output / Electrical entry: Wiring top entry	—	●	●	●	●	●	●		

Regulator *Series AR10 to AR60* Regulator with Backflow Function *Series AR20K to AR60K*



AR20, AR20K AR40, AR40K

	Symbol	Description	① Body size									
			10	20	25	30	40	50	60			
⑥ Semi-standard	c	Nil ^{Note 5)}	0.05 to 0.85 MPa setting		●	●	●	●	●	●	●	
		1 ^{Note 6)}	0.02 to 0.2 MPa setting		●	●	●	●	●	●	●	
			+									
	d	Exhaust mechanism	Nil	Relieving type		●	●	●	●	●	●	●
			N	Non-relieving type		●	●	●	●	●	●	●
			+									
	e	Flow direction	Nil	Flow direction: Left to right		●	●	●	●	●	●	●
			R	Flow direction: Right to left		●	●	●	●	●	●	●
			+									
	f	Knob	Nil	Downward		●	●	●	●	●	●	●
			Y	Upward		●	●	●	●	●	●	●
			+									
g	Pressure unit	Nil	Name plate and pressure gauge in imperial units: MPa		●	●	●	●	●	●	●	
		Z ^{Note 7)}	Name plate and pressure gauge in imperial units: psi		○ ^{Note 9)}	○ ^{Note 9)}	○ ^{Note 9)}	○ ^{Note 9)}	○ ^{Note 9)}	○ ^{Note 9)}	○ ^{Note 9)}	
		ZA ^{Note 8)}	Digital pressure switch: With unit conversion function		—	△ ^{Note 10)}	△ ^{Note 10)}	△ ^{Note 10)}	△ ^{Note 10)}	△ ^{Note 10)}	△ ^{Note 10)}	

Note 1) The AR10 type comes with a backflow function as a standard feature. (K is not available.) When using the AR10 type as w/ backflow function, backflow may not occur with the set pressure 0.15 MPa or less. Please set the inlet pressure to at least 0.05 MPa higher than the set pressure.

Note 2) Option B, G, H, M are not assembled and supplied loose at the time of shipment.

Note 3) Assembly of a bracket and set nuts (AR10, AR20(K) to AR40(K))
Including 2 mounting screws for the AR50(K) and AR60(K)

Note 4) When choosing with H (panel mount), the installation space for lead wires will not be secured. In this case, select "wiring top entry" for the electrical entry. (Select "wiring bottom entry" when the semi-standard Y is chosen simultaneously.)

Note 5) Only the AR10 has a pressure setting of 0.05 to 0.7 MPa.

Note 6) The only difference from the standard specifications is the adjusting spring for the regulator. It does not restrict the setting of 0.2 MPa or more. When the pressure gauge is attached, a 0.2 MPa pressure gauge will be fitted.

Note 7) For thread type: M5 and NPT. This product is for overseas use only according to the new Measurement Law. (The SI unit type is provided for use in Japan.)
The digital pressure switch will be equipped with the unit conversion function, setting to psi initially.

The combination of the round type pressure gauge with color zone "M" and a psi display "Z" is not orderable as a standard product. However, this combination is available as a special.

Note 8) For options: E1, E2, E3, E4. This product is for overseas use only according to the new Measurement Law. (The SI unit is provided for use in Japan.)

Note 9) ○: For thread type: M5 and NPT only
Note 10) △: Select with options: E1, E2, E3, E4.

Standard Specifications

Model	AR10	AR20(K)	AR25(K)	AR30(K)	AR40(K)	AR40(K)-06	AR50(K)	AR60(K)	
Port size	M5 x 0.8	1/8, 1/4	1/4, 3/8	1/4, 3/8	1/4, 3/8, 1/2	3/4	3/4, 1	1	
Pressure gauge port size ^{Note 1)}	1/16 ^{Note 2)}	1/8		1/4					
Fluid	Air								
Ambient and fluid temperature ^{Note 3)}	-5 to 60°C (with no freezing)								
Proof pressure	1.5 MPa								
Maximum operating pressure	1.0 MPa								
Set pressure range	0.05 to 0.7 MPa	0.05 to 0.85 MPa							
Relief pressure ^{Note 4)}	Set pressure + 0.05 MPa [at relief flow rate of 0.1 ℓ/min (ANR)]								
Construction	Relieving type								
Mass (kg)	0.06	0.16	0.21	0.29	0.44	0.47	1.17	1.22	

Note 1) Pressure gauge connection threads are not available for F.R.L. unit with a square embedded type pressure gauge (AR20(K) to AR60(K)).

Note 2) Use a bushing (part no:131368) when connecting the R1/8 pressure gauge to the Rc1/16.

Note 3) -5 to 50°C for the products with the digital pressure switch.

Note 4) Not applicable to the AR10.

AC
AF□
AR
AL
AW□
A□G
AV
AF800
AF900

Series AR10 to AR60

Series AR20K to AR60K

Options/Part No.

Option		Model	AR10	AR20(K)	AR25(K)	AR30(K)	AR40(K)	AR40(K)-06	AR50(K)	AR60(K)	
Bracket assembly ^{Note 1)}			AR10P-270AS	AR20P-270AS	AR25P-270AS	AR30P-270AS	AR40P-270AS		AR50P-270AS ^{Note 2)}		
Set nut			AR10P-260S	AR20P-260S	AR25P-260S	AR30P-260S	AR40P-260S		___ ^{Note 3)}	___ ^{Note 3)}	
Pressure gauge	^{Note 4)} Round type	Standard	G27-10-R1		G36-10-□01		G46-10-□02				
		0.02 to 0.2 MPa setting	G27-10-R1 ^{Note 5)}		G36-2-□01		G46-2-□02				
	^{Note 4)} Round type (with color zone)	Standard	—		G36-10-□01-L		G46-10-□02-L				
		0.02 to 0.2 MPa setting	—		G36-2-□01-L		G46-2-□02-L				
	^{Note 6)} Square embedded type	Standard	—		GC3-10AS [GC3P-010AS (Pressure gauge cover only)]						
		0.02 to 0.2 MPa setting	—		GC3-2AS [GC3P-010AS (Pressure gauge cover only)]						
Digital pressure switch	NPN output: Wiring bottom entry		—		ISE35-N-25-MLA [ISE35-N-25-M (Switch body only)] ^{Note 7)}						
	NPN output: Wiring top entry				ISE35-R-25-MLA [ISE35-R-25-M (Switch body only)] ^{Note 7)}						
	PNP output: Wiring bottom entry				ISE35-N-65-MLA [ISE35-N-65-M (Switch body only)] ^{Note 7)}						
	PNP output: Wiring top entry				ISE35-R-65-MLA [ISE35-R-65-M (Switch body only)] ^{Note 7)}						

Note 1) Assembly of a bracket and set nuts

Note 2) Assembly of a bracket and 2 mounting screws

Note 3) Please consult with SMC regarding the set nuts for the AR50(K) and AR60(K).

Note 4) □ in part numbers for a round pressure gauge indicates a type of connection thread. No indication is necessary for R; however, indicate N for NPT. Please contact SMC regarding the connection thread NPT and pressure gauge supply for psi unit specifications.

Note 5) Pressure gauge for general purpose

Note 6) Including one O-ring and 2 mounting screws. []: Pressure gauge cover only

Note 7) Lead wire with connector (2 m), adapter, lock pin, O-ring (1 pc.), mounting screw (2 pcs.) are attached. []: Switch body only

Also, regarding how to order the digital pressure switch, please refer to page 388.

⚠ Specific Product Precautions

Be sure to read before handling. Refer to front matters 42 and 43 for Safety Instructions and pages 287 to 291 for F.R.L. Precautions.

Selection

⚠ Warning

- Residual pressure disposal (outlet pressure removal) is not possible for the AR20 to AR60 even though the inlet pressure is exhausted. When the residual pressure disposal is performed, use the regulator with a backflow function (AR20K to AR60K).

Maintenance

⚠ Warning

- When using the regulator with backflow function between a solenoid valve and an actuator, check the pressure gauge periodically. Sudden pressure fluctuations may shorten the durability of the pressure gauge. A digital pressure gauge is recommended for such situation or as deemed necessary.

Mounting and Adjustment

⚠ Warning

- Set the regulator while verifying the displayed values of the inlet and outlet pressure gauges. Turning the regulator knob excessively can cause damage to the internal parts.
- The pressure gauge included with regulators for 0.02 to 0.2 MPa setting is for up to 0.2 MPa use only (except the AR10). Exceeding 0.2 MPa of pressure can damage the gauge.
- Do not use tools on the pressure regulator knob as this may cause damage. It must be operated manually.

⚠ Caution

- Be sure to unlock the knob before adjusting the pressure and lock it after setting the pressure. Failure to follow this procedure can cause damage to the knob and the outlet pressure may fluctuate.
 - Pull the pressure regulator knob to unlock. (You can visually verify this with the "orange mark" that appears in the gap.)
 - Push the pressure regulator knob to lock. When the knob is not easily locked, turn it left and right a little and then push it (when the knob is locked, the "orange mark", i.e., the gap will disappear).

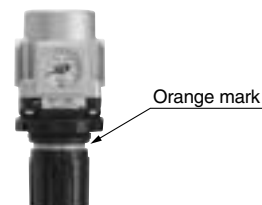

- A knob cover is available to prevent careless operation of the knob. Refer to page 389 for details.

Regulator *Series AR10 to AR60* Regulator with Backflow Function *Series AR20K to AR60K*

Flow Characteristics (Representative values)

Condition: Inlet pressure 0.7 MPa

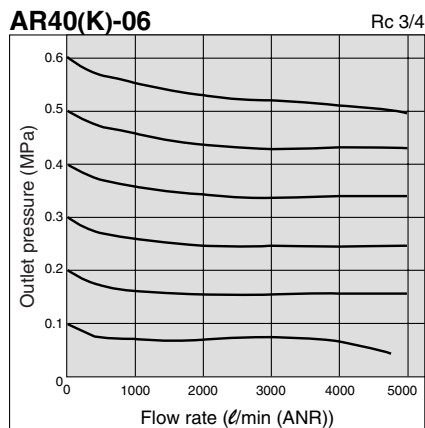
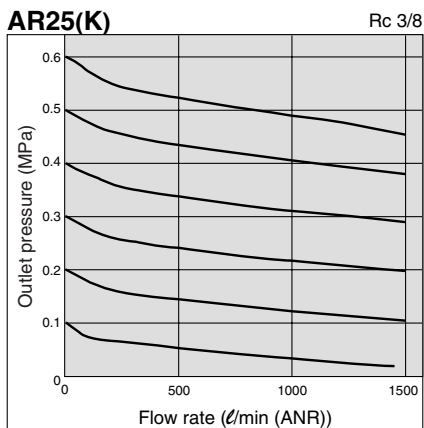
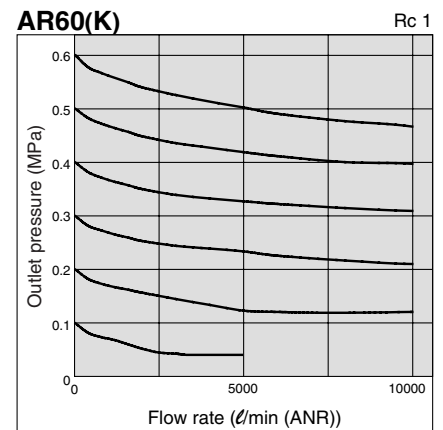
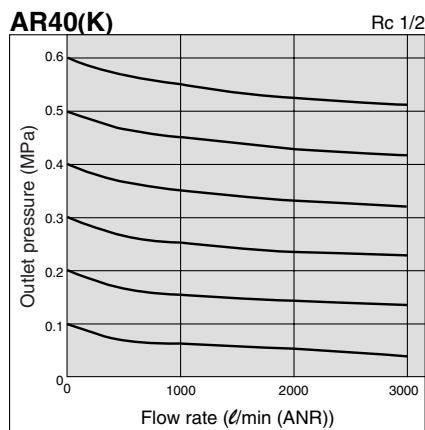
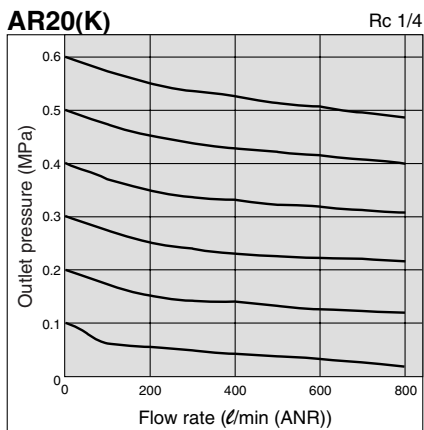
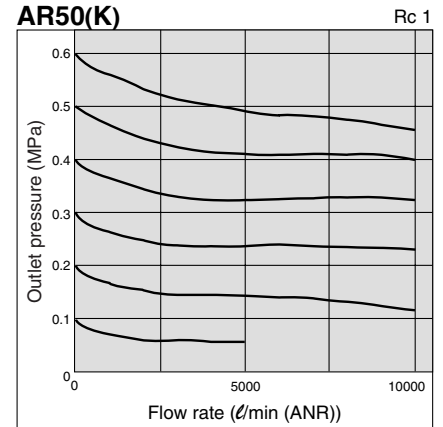
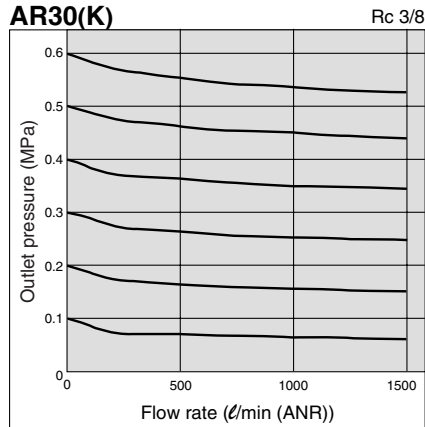
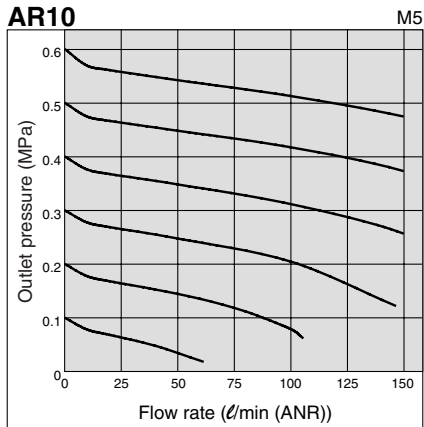

AC

AF □

AR

AL

AW □

A □ **G**

AV

AF800
AF900

Series AR10 to AR60

Series AR20K to AR60K

Pressure Characteristics (Representative values)

Conditions: Inlet pressure 0.7 MPa, Outlet pressure 0.2 MPa, Flow rate 20 l/min (ANR)

AR10

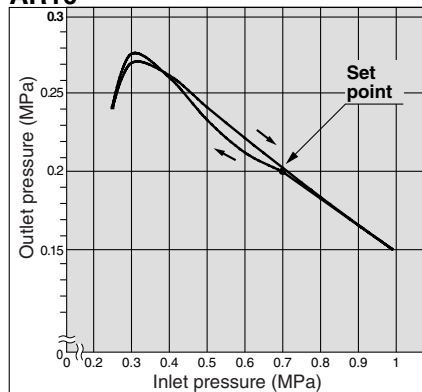

AR30(K)

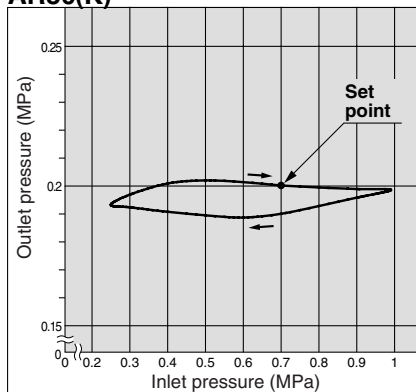

AR50(K)

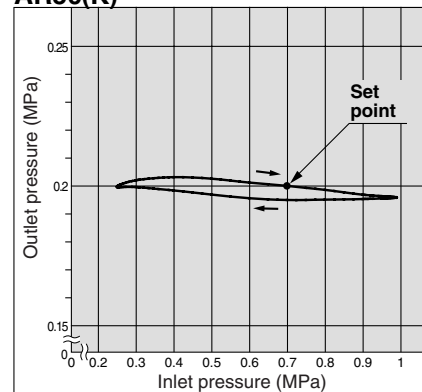

AR20(K)

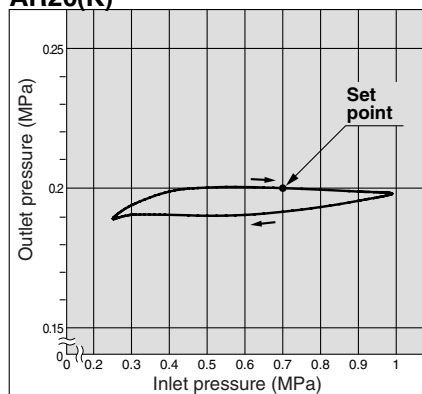

AR40(K)

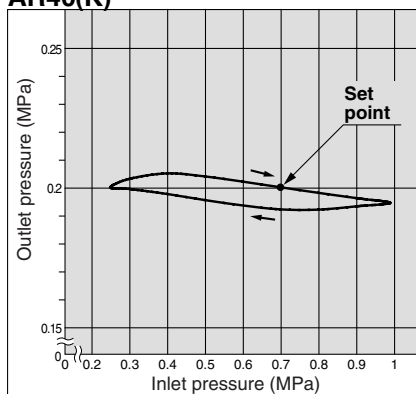

AR60(K)

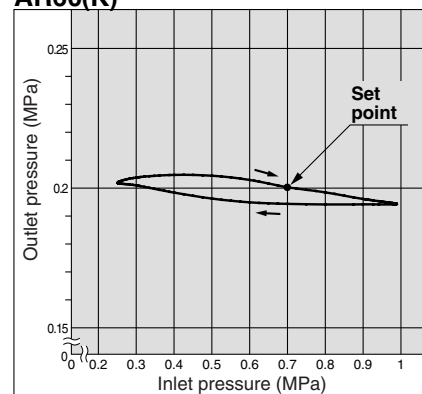

AR25(K)

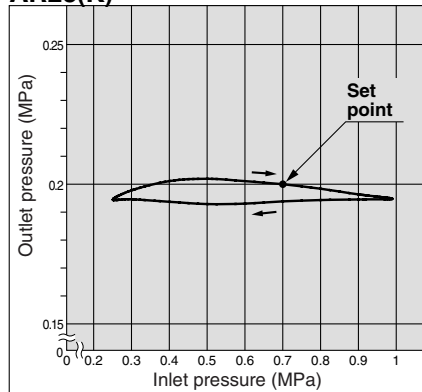

AR40(K)-06

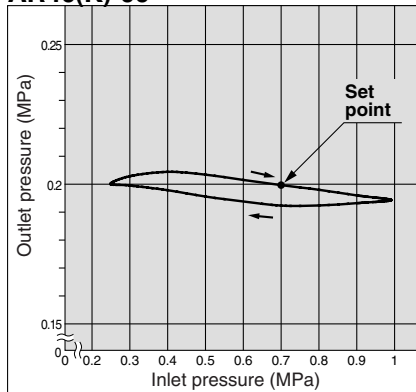

Regulator *Series AR10 to AR60*

Regulator with Backflow Function *Series AR20K to AR60K*

Construction

AR10

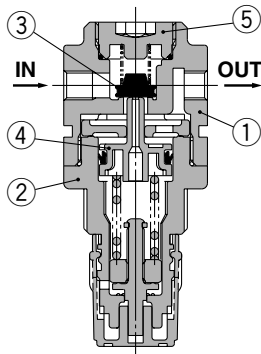

AR20(K), AR25(K)

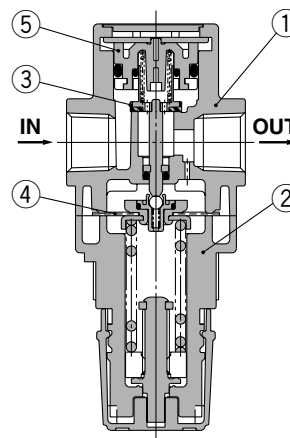

AR30(K), AR40(K)

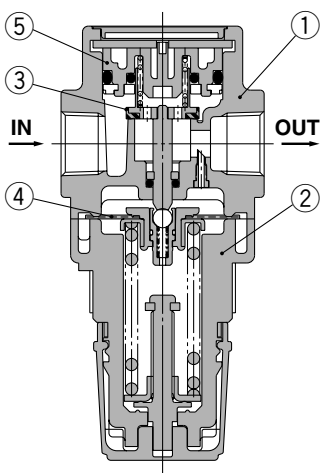

AR50(K), AR60(K)

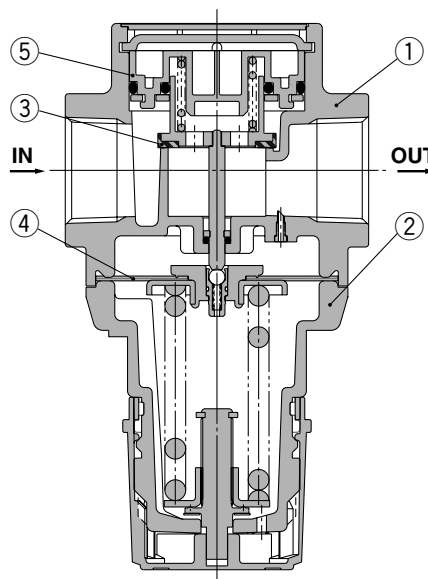

AR20K to AR60K (Regulator with Backflow Function)

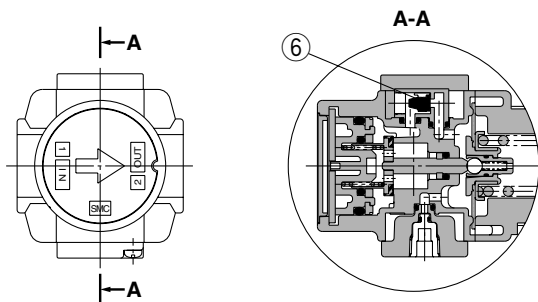

Component Parts

No.	Description	Material	Model	Color
1	Body	Zinc die-cast	AR10	Platinum silver
		Aluminum die-cast	AR20(K) to AR60(K)	
2	Bonnet	Polyacetal	AR10, AR20(K) to AR40(K)-06	Black
		Aluminum die-cast	AR50(K), AR60(K)	

Replacement Parts

No.	Description	Material	Part no.						
			AR10	AR20(K)	AR25(K)	AR30(K)	AR40(K)	AR40(K)-06	AR50(K)
3	Valve assembly	Brass, HNBR	AR10P-090S	AR20P-410S	AR25P-410S	AR30P-410S	AR40P-410S	AR50P-410S	AR60P-410S
4	Diaphragm assembly	Weatherable NBR	AR10P-150AS ^{Note 1)}	AR20P-150AS	AR25P-150AS	AR30P-150AS	AR40P-150AS	AR50P-150AS	
5	Valve guide assembly	Polyacetal	131329	AR20P-050AS	AR25P-050AS	AR30P-050AS	AR40P-050AS	AR50P-050AS	AR60P-050AS
6	Check valve assembly ^{Note 2)}	—	—	AR20KP-020AS					

Note 1) The AR10 is a piston type. Assembly of a piston and a seal (KSYP-13).

Note 2) Check valve assembly is applicable for a regulator with backflow function (AR20K to AR60K) only.

Assembly of a check valve cover, check valve body assembly and 2 screws

AC

AF□

AR

AL

AW□

A□G

AV

AF800
AF900

Series AR10 to AR60

Series AR20K to AR60K

Working Principle (Regulator with Backflow Function)

AR10

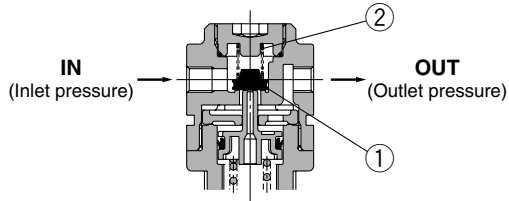

Figure 1

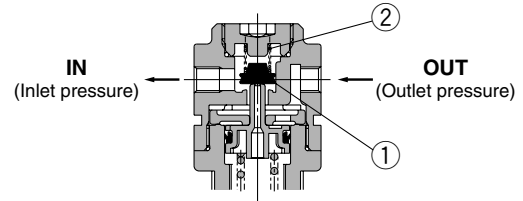

Figure 2

When the inlet pressure is higher than the regulating pressure, the check valve operates as a normal regulator (Figure 1).

When the inlet pressure is shut off and exhausted, any inlet pressure applied to the valve ① will be lost. The force for seating the valve ① is the valve spring force ② only. When the valve ① is opened using the outlet force, the outlet pressure will be exhausted at the inlet side. (Figure 2)

When the set pressure is 0.15 MPa or less, valve ① may not open due to the valve spring ② force.

AR20K to AR60K

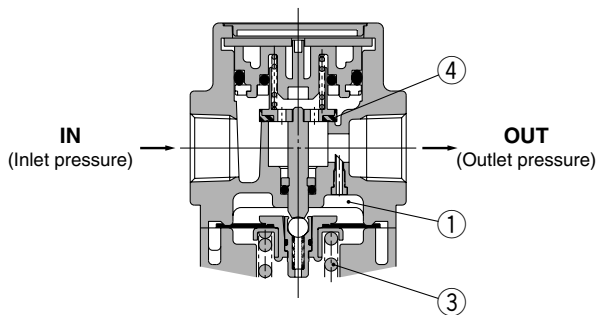
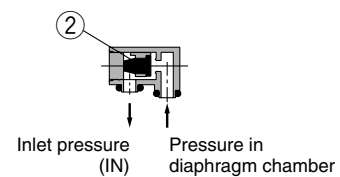
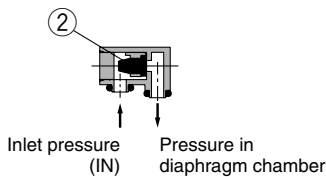
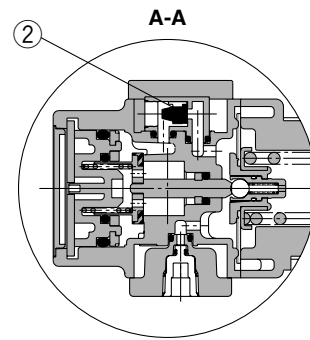
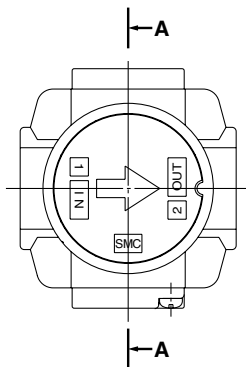

Figure 1 Normal

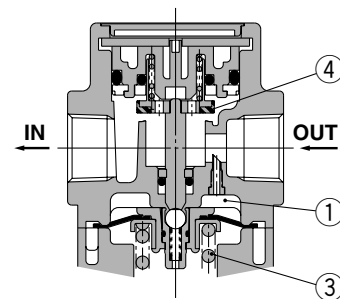

Figure 2 Backflow

When the inlet pressure is higher than the regulating pressure, the check valve ② closes and operates as a normal regulator (Figure 1). When the inlet pressure is shut off and released, the check valve ② opens and the pressure in the diaphragm chamber ① is released into the inlet side (Figure 2).

This lowers the pressure in the diaphragm chamber ① and the force generated by the pressure regulator spring ③ lifts the diaphragm. Valve ④ opens through the stem, and the outlet pressure is released to the inlet side (Figure 2).

Regulator *Series AR10 to AR60*

Regulator with Backflow Function *Series AR20K to AR60K*

Dimensions

AR10, AR20(K) to AR40(K)-06

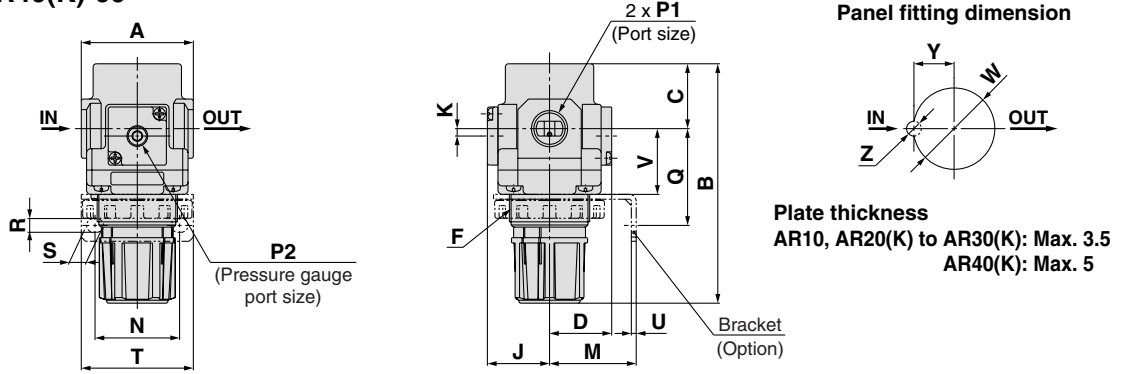

AR50(K), AR60(K)

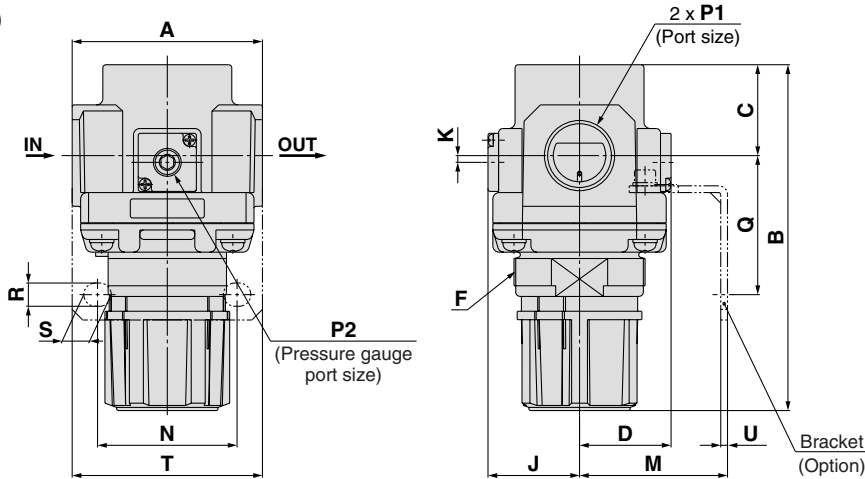

Applicable model	AR20(K) to AR60(K)		AR10, AR20(K) to AR60(K)	AR20(K) to AR60(K)
Option	Square embedded type pressure gauge	Digital pressure switch	Round type pressure gauge	Round type pressure gauge (with color zone)
Dimensions				

Model	Standard specifications										Optional specifications						
	P1	P2	A	B ^{Note 1)}	C	D	F	J	K	H	J	H	J	H	J	H	J
AR10	M5 x 0.8	1/16	25	58	11	12.5	M18 x 1	13	0	—	—	—	—	ø26	26	—	—
AR20(K)	1/8, 1/4	1/8	40	94	26.5	28.5	M28 x 1	28.5	2 ^{Note 2)}	□28	29.5	□27.8	40	ø37.5	65	ø37.5	65
AR25(K)	1/4, 3/8	1/8	53	101	28	27.5	M32 x 1.5	27.5	0	□28	28.5	□27.8	39	ø37.5	64	ø37.5	64
AR30(K)	1/4, 3/8	1/8	53	116	31	29.5	M38 x 1.5	29.5	3.5	□28	30.5	□27.8	41	ø37.5	66	ø37.5	66
AR40(K)	1/4, 3/8, 1/2	1/4	70	128	36	34	M42 x 1.5	34	3.5	□28	35	□27.8	45	ø42.5	74	ø42.5	74
AR40(K)-06	3/4	1/4	75	129	36	34	M42 x 1.5	34	3	□28	35	□27.8	45	ø42.5	74	ø42.5	74
AR50(K)	3/4, 1	1/4	90	169	43	43.5	M62 x 1.5	43.5	3.3	□28	44.5	□27.8	55	ø42.5	84	ø42.5	84
AR60(K)	1	1/4	95	176	46	43.5	M62 x 1.5	43.5	3.3	□28	44.5	□27.8	55	ø42.5	84	ø42.5	84

Model	Optional specifications												
	Bracket mount								Panel mount				
	M	N	Q	R	S	T	U	V	W	Y	Z		
AR10	25	28	30	4.5	6.5	40	2	18	18.5	—	—		
AR20(K)	30	34	44	5.4	15.4	55	2.3	25	28.5	14	6		
AR25(K)	30	34	44	5.4	15.4	55	2.3	26	32.5	16	6		
AR30(K)	41	40	46	6.5	8	53	2.3	31	38.5	19	7		
AR40(K)	50	54	54	8.5	10.5	70	2.3	35.5	42.5	21	7		
AR40(K)-06	50	54	56	8.5	10.5	70	2.3	37	42.5	21	7		
AR50(K)	70	66	65.8	11	13	90	3.2	—	—	—	—		
AR60(K)	70	66	65.8	11	13	90	3.2	—	—	—	—		

Note 1) The total length of B dimension is the length when the filter regulator knob is unlocked.
 Note 2) For the AR20 only, the position of the pressure gauge is above the center of the piping.

- AC
- AF□
- AR
- AL
- AW□
- A□G
- AV
- AF800
- AF900

Regulator AR20 to AR60 Made to Order Specifications:

Please contact SMC for detailed dimensions, specifications, and lead times.



AR30-03G-X440 AR30-03-X425

① Special Temperature Environment

Special materials are used in the manufacturing of seals and resin parts to allow them to withstand various temperature conditions in cold or tropical (hot) climates.

Specifications

Made-to-order part no.	-X430	-X440
Environment	Low temperature	High temperature
Ambient temperature (°C)	-30 to 60	-5 to 80
Fluid temperature (°C)	-5 to 60 (with no freezing)	
Material	Rubber parts	Special NBR
	Main parts	FKM
	Metal (Aluminum die-cast), etc.	

Applicable Model

Model	AR25	AR30	AR40	AR40-06	AR50	AR60
Port size	1/4, 3/8	1/4, 3/8	1/4, 3/8, 1/2	3/4	3/4, 1	1

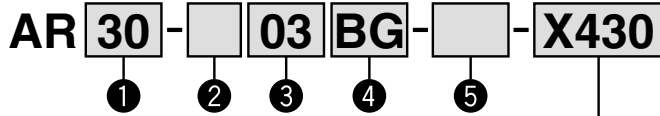

- Option/Semi-standard: Select one each for a to g.
 - Option/Semi-standard symbol: When more than one specification is required, indicate in alphanumeric order.
- Example) AR30-03BG-1NR-X430

For high/low temperature

X430	Low temperature
X440	High temperature

	Symbol	Description	① Body size					
			25	30	40	50	60	
② Thread type	Nil	Rc	●	●	●	●	●	
	N	NPT	●	●	●	●	●	
	F	G	●	●	●	●	●	
+								
③ Port size	02	1/4	●	●	●	—	—	
	03	3/8	●	●	●	—	—	
	04	1/2	—	—	●	—	—	
	06	3/4	—	—	●	●	—	
	10	1	—	—	—	●	●	
+								
④ Option	a Mounting	Nil	Without mounting option	●	●	●	●	●
		B Note 2)	With bracket	●	●	●	●	●
		H	With set nut (for panel fitting)	●	●	●	—	—
+								
b Pressure gauge	G Note 3)	Nil	Round type pressure gauge (without limit indicator)	●	●	●	●	●
		G	Round type pressure gauge (with limit indicator)	●	●	●	●	●
+								
c Set pressure	1 Note 4)	Nil	0.05 to 0.85 MPa setting	●	●	●	●	●
		1	0.02 to 0.2 MPa setting	●	●	●	●	●
+								
d Exhaust mechanism	Nil	Nil	Relieving type	●	●	●	●	●
		N	Non-relieving type	●	●	●	●	●
+								
e Flow direction	Nil	Nil	Flow direction: Left to right	●	●	●	●	●
		R	Flow direction: Right to left	●	●	●	●	●
+								
f Knob	Nil	Nil	Downward	●	●	●	●	●
		Y	Upward	●	●	●	●	●
+								
g Pressure unit	Nil	Nil	Name plate and pressure gauge in imperial units: MPa	●	●	●	●	●
		Z Note 5)	Name plate and caution plate for bowl in imperial units: psi	○	○	○	○	○
+								
			Note 6)	Note 6)	Note 6)	Note 6)	Note 6)	

- Note 1) Option B, G, H are not assembled and supplied loose at the time of shipment.
 Note 2) Assembly of a bracket and set nuts (AR25 to AR40) Including 2 mounting screws for the AR50 and AR60
 Note 3) Mounting thread for pressure gauge: 1/8 for the AR25 to AR30; 1/4 for the AR40 to AR60. Pressure gauge type: G43
 Note 4) The only difference from the standard specifications is the adjusting spring for the regulator. It does not restrict the setting of 0.2 MPa or more. When the pressure gauge is attached, a 0.2 MPa pressure gauge will be fitted.
 Note 5) For thread type: NPT. This product is for overseas use only according to the new Measurement Law. (The SI unit type is provided for use in Japan.)
 Note 6) ○: For thread type: NPT only

② High Pressure

Strong materials are used in the manufacturing of air filters intended for high pressure operation. Also, construction modification allows a wider regulating pressure range.

Specifications

Made-to-order part no.	-X425
Proof pressure (MPa)	3.0
Maximum operating pressure (MPa)	2.0
Set pressure range (MPa)	0.1 to 1.6
Ambient and fluid temperature (°C)	-5 to 60 (with no freezing)

Applicable Model

Model	AR20	AR25	AR30	AR40	AR40-06	AR50	AR60
Port size	1/8, 1/4	1/4, 3/8	1/4, 3/8	1/4, 3/8, 1/2	3/4	3/4, 1	1

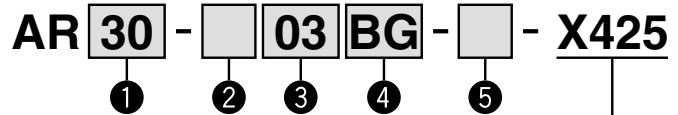

For high pressure

- Option/Semi-standard: Select one each for a to f.
 - Option/Semi-standard symbol: When more than one specification is required, indicate in alphabetic order.
- Example) AR30-03BG-NR-X425

	Symbol	Description	① Body size					
			20	25	30	40	50	60
② Thread type	Nil	Rc	●	●	●	●	●	
	N	NPT	●	●	●	●	●	
	F	G	●	●	●	●	●	
+								
③ Port size	01	1/8	●	—	—	—	—	
	02	1/4	●	●	●	—	—	
	03	3/8	—	●	●	—	—	
	04	1/2	—	—	●	—	—	
	06	3/4	—	—	—	●	●	
+								
④ Option	a Mounting	Nil	Without mounting option	●	●	●	●	●
		B Note 2)	With bracket	●	●	●	●	●
		H	With set nut (for panel fitting)	●	●	●	—	—
+								
b Pressure gauge	G Note 3)	Nil	Round type pressure switch (without limit indicator)	●	●	●	●	●
		G	Round type pressure switch (with limit indicator)	●	●	●	●	●
+								
c Exhaust mechanism	Nil	Nil	Relieving type	●	●	●	●	●
		N	Non-relieving type	●	●	●	●	●
+								
d Flow direction	Nil	Nil	Flow direction: Left to right	●	●	●	●	●
		R	Flow direction: Right to left	●	●	●	●	●
+								
e Knob	Nil	Nil	Downward	●	●	●	●	●
		Y	Upward	●	●	●	●	●
+								
f Pressure unit	Nil	Nil	Name plate and pressure gauge in imperial units: MPa	●	●	●	●	●
		Z Note 4)	Name plate and caution plate for bowl in imperial units: psi	○	○	○	○	○
+								
			Note 5)	Note 5)	Note 5)	Note 5)	Note 5)	

- Note 1) Option B, G, H are not assembled and supplied loose at the time of shipment.
 Note 2) Assembly of a bracket and set nuts (AR20 to AR40) Including 2 mounting screws for the AR50 and AR60
 Note 3) Mounting thread for pressure gauge: 1/8 for AR20 to AR30, 1/4 for AR40 to AR60. Pressure gauge type: G46-20-□
 Note 4) For thread type: NPT. This product is for overseas use only according to the new Measurement Law. (The SI unit type is provided for use in Japan.)
 Note 5) ○: For thread type: NPT only

Regulator AR10 to AR60

Regulator with Backflow Function AR20K to AR60K

Made to Order Specifications:



Please contact SMC for detailed dimensions, specifications, and lead times.

③ 0.4 MPa Setting

The maximum set pressure is 0.4 MPa. When a pressure gauge is included, the display will show a range from 0 to 0.4 MPa.

Specifications

Proof pressure	1.5 MPa
Maximum operating pressure	1.0 MPa
Set pressure range	0.05 to 0.4 MPa

Applicable Model

Model	AR10	AR20(K)	AR25(K)	AR30(K)	AR40(K)	AR40(K)-06	AR50(K)	AR60(K)
Port size	M5	1/8, 1/4	1/4, 3/8	1/4, 3/8	1/4, 3/8, 1/2	3/4	3/4, 1	1

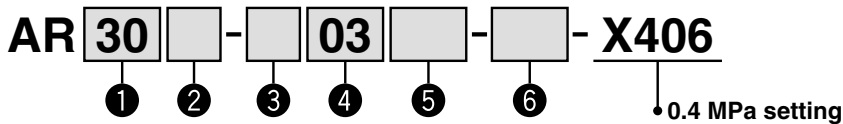

- Option/Semi-standard: Select one each for a to f.
- Option/Semi-standard symbol: When more than one specification is required, indicate in alphabetic order.
Example) AR30K-03BE-NR-X406

		Symbol	Description	① Body size							
				10	20	25	30	40	50	60	
②	With backflow function	Nil	Without backflow function	●	●	●	●	●	●	●	
		K <small>Note 1)</small>	With backflow function	—	●	●	●	●	●	●	
		+									
③	Thread type	Nil	Metric thread (M5)	●	—	—	—	—	—	—	
		Rc		—	●	●	●	●	●	●	
		N	NPT	—	●	●	●	●	●	●	
		F	G	—	●	●	●	●	●	●	
		+									
④	Port size	M5	M5	●	—	—	—	—	—	—	
		01	1/8	—	●	—	—	—	—	—	
		02	1/4	—	●	●	—	—	—	—	
		03	3/8	—	●	●	●	—	—	—	
		04	1/2	—	—	—	●	—	—	—	
		06	3/4	—	—	—	—	●	●	—	
		10	1	—	—	—	—	—	●	●	
		+									
⑤	a	Mounting	Nil	Without mounting option	●	●	●	●	●	●	●
			B <small>Note 3)</small>	With bracket	●	●	●	●	●	●	●
			H	With set nut (for panel fitting)	●	●	●	●	●	—	—
			+								
	b	Pressure gauge	Nil	Without pressure gauge	●	●	●	●	●	●	●
			E	Square embedded type pressure gauge (with limit indicator)	—	●	●	●	●	●	●
			G	Round type pressure gauge (without limit indicator)	●	—	—	—	—	—	—
			M	Round type pressure gauge (with limit indicator)	—	●	●	●	●	●	●
			M	Round type pressure gauge (with color zone)	—	●	●	●	●	●	●
	Digital pressure switch	E1 <small>Note 4)</small>	Output: NPN output / Electrical entry: Wiring bottom entry	—	●	●	●	●	●	●	
		E2 <small>Note 4)</small>	Output: NPN output / Electrical entry: Wiring top entry	—	●	●	●	●	●	●	
		E3 <small>Note 4)</small>	Output: PNP output / Electrical entry: Wiring bottom entry	—	●	●	●	●	●	●	
		E4 <small>Note 4)</small>	Output: PNP output / Electrical entry: Wiring top entry	—	●	●	●	●	●	●	
		+									
⑥	c	Exhaust mechanism	Nil	Relieving type	●	●	●	●	●	●	
			N	Non-relieving type	●	●	●	●	●	●	
			+								
	d	Flow direction	Nil	Flow direction: Left to right	●	●	●	●	●	●	
			R	Flow direction: Right to left	●	●	●	●	●	●	
			+								
e	Knob	Nil	Downward	●	●	●	●	●	●		
		Y	Upward	●	●	●	●	●	●		
		+									
f	Pressure unit	Nil	Name plate and pressure gauge in imperial units: MPa	○ <small>Note 7)</small>	○ <small>Note 7)</small>	○ <small>Note 7)</small>	○ <small>Note 7)</small>	○ <small>Note 7)</small>	○ <small>Note 7)</small>	○ <small>Note 7)</small>	
		Z <small>Note 5)</small>	Name plate and pressure gauge in imperial units: psi	○ <small>Note 7)</small>	○ <small>Note 7)</small>	○ <small>Note 7)</small>	○ <small>Note 7)</small>	○ <small>Note 7)</small>	○ <small>Note 7)</small>	○ <small>Note 7)</small>	
		ZA <small>Note 6)</small>	Digital pressure switch: With unit switching function	—	△ <small>Note 8)</small>	△ <small>Note 8)</small>	△ <small>Note 8)</small>	△ <small>Note 8)</small>	△ <small>Note 8)</small>	△ <small>Note 8)</small>	

- Note 1) The AR10 type comes with a backflow function as a standard feature. (K is not available.) When using the AR10 type as w/ backflow function, backflow may not occur with the set pressure 0.15 MPa or less. Please set the inlet pressure to at least 0.05 MPa higher than the set pressure.
- Note 2) Option B, G, H are not assembled and supplied loose at the time of shipment.
- Note 3) Assembly of a bracket and set nuts (AR10, AR20(K) to AR40(K)) Including 2 mounting screws for the AR50(K), AR60(K)
- Note 4) When choosing with H (panel mount), the installation space for lead wires will not be secured. In this case, select "wiring top entry" for the electrical entry.

- (Select "wiring bottom entry" when the semi-standard Y is chosen simultaneously.)
- Note 5) For thread type: M5 and NPT. This product is for overseas use only according to the new Measurement Law. (The SI unit type is provided for use in Japan.) The digital pressure switch will be equipped with the unit conversion function, setting to psi initially.
- Note 6) For options: E1, E2, E3, E4. This product is for overseas use only according to the new Measurement Law. (The SI unit is provided for use in Japan.)
- Note 7) ○: For thread type: M5 and NPT only
- Note 8) △: Select with options: E1, E2, E3, E4.

- AC
- AF□
- AR
- AL
- AW□
- A□G
- AV
- AF800
- AF900

Modular Type Lubricators *Series AL*

Lubricator Series AL	Model	Port size	Option
	AL10	M5 x 0.8	Bracket
	AL20	1/8, 1/4	
	AL30	1/4, 3/8	
	AL40	1/4, 3/8, 1/2	
	AL40-06	3/4	
	AL50	3/4, 1	
	AL60	1	
	Pages 358 through to 363		

AC

AF□

AR

AL

AW□

A□G

AV

AF800
AF900

Lubricator

AL10 to AL60

JIS Symbol
Lubricator

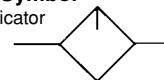

How to Order

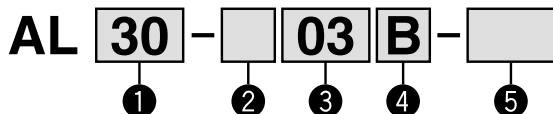

• Option/Semi-standard: Select one each for a to d.
• Option/Semi-standard symbol: When more than one specification is required, indicate in alphanumeric order.
Example) AL30-03B-2R

		Symbol	Description	①							
				Body size							
				10	20	30	40	50	60		
②	Thread type	Nil	Metric thread (M5)	●	—	—	—	—	—		
		N	Rc	—	●	●	●	●	●		
		F	NPT	—	●	●	●	●	●		
			G	—	●	●	●	●	●		
		+									
③	Port size	M5	M5	●	—	—	—	—	—		
		01	1/8	—	●	—	—	—	—		
		02	1/4	—	●	●	—	—	—		
		03	3/8	—	—	●	●	—	—		
		04	1/2	—	—	—	●	—	—		
		06	3/4	—	—	—	—	●	—		
		10	1	—	—	—	—	●	●		
		+									
④	Option (Mounting)	Nil	Without mounting option	●	●	●	●	●	●		
		B ^{Note 1)}	With bracket	—	●	●	●	●	●		
		+									
⑤	Semi-standard	a	Bowl ^{Note 2)}	Nil	Polycarbonate bowl	●	●	●	●	●	●
				1	1000 cm ³ tank	—	—	△ ^{Note 3)}	△ ^{Note 3)}	△ ^{Note 3)}	△ ^{Note 3)}
				10	1000 cm ³ tank (with switch) Lowest limit ON	—	—	△ ^{Note 3)}	△ ^{Note 3)}	△ ^{Note 3)}	△ ^{Note 3)}
				11	1000 cm ³ tank (with switch) Lowest limit OFF	—	—	△ ^{Note 3)}	△ ^{Note 3)}	△ ^{Note 3)}	△ ^{Note 3)}
				2	Metal bowl	●	●	●	●	●	●
				6	Nylon bowl	●	●	●	●	●	●
				8	Metal bowl with level gauge	—	—	●	●	●	●
		b	Lubricant exhaust port	Nil	Without drain cock	●	●	●	●	●	●
				3	With drain cock	●	●	●	●	●	●
		c	Flow direction	3W	Drain cock with barb fitting: For ø6 x ø4 nylon tube	—	—	●	●	●	●
				Nil	Flow direction: Left to right	●	●	●	●	●	●
		d	Pressure unit	R	Flow direction: Right to left	●	●	●	●	●	●
				Nil	Name plate and caution plate for bowl in imperial units: MPa	●	●	●	●	●	●
		+									
		Z ^{Note 4)}		Name plate and caution plate for bowl in imperial units: psi, °F							
				○ ^{Note 5)}	○ ^{Note 5)}	○ ^{Note 5)}	○ ^{Note 5)}	○ ^{Note 5)}	○ ^{Note 5)}		

Note 1) Option B is not assembled and supplied loose at the time of shipment.

Note 2) Refer to Chemical Data on page 287 when selecting a case material.

Note 3) △: Dedicated lubricant discharge function is equipped, and semi-standard b-3, or 3W are not available.

Note 4) For thread type: M5 and NPT. This product is for overseas use only according to the new Measurement Law. (The SI unit type is provided for use in Japan.)

Note 5) ○: For thread type: M5 and NPT only

Standard Specifications

Model	AL10	AL20	AL30	AL40	AL40-06	AL50	AL60
Port size	M5 x 0.8	1/8, 1/4	1/4, 3/8	1/4, 3/8, 1/2	3/4	3/4, 1	1
Fluid	Air						
Proof pressure	1.5 MPa						
Maximum operating pressure	1.0 MPa						
Ambient and fluid temperature	-5 to 60°C (with no freezing)						
Minimum dripping flow rate ^{Note)} [μ /min (ANR)]	4	15	1/4: 30 3/8: 40	1/4: 30 3/8: 40 1/2: 50	50	190	220
Oil capacity (cm³)	7	25	55	135			
Recommended lubricant	Class 1 turbine oil (ISO VG32)						
Bowl material	Polycarbonate						
Bowl guard	—	Semi-standard	Standard				
Mass (kg)	0.07	0.11	0.24	0.47	0.52	1.06	1.13

Note) • The flow rate is 5 drips or greater/min under the following conditions: Inlet pressure of 0.5 MPa; Class 1 turbine oil (ISO VG32); Temperature at 20°C; Oil adjustment valve fully opened.

- Use air consumption flow rate for minimum dripping flow rate.

Option/Part No.

Optional specifications	Model						
	AL10	AL20	AL30	AL40	AL40-06	AL50	AL60
Bracket assembly ^{Note)}	—	AF20P-050AS	AF30P-050AS	AF40P-050AS	AF40P-070AS	AF50P-050AS	AF50P-050AS

Note) Assembly of a bracket and 2 mounting screws. The part number for bracket assembly for 1000 cm³ is AF50P-050AS (applicable to the AL30 to AL60).

Semi-standard/Bowl Assembly Part No.

Semi-standard specifications						Model						
Bowl material	With drain guide	With barb fitting	With bowl guard	With switch		AL10	AL20	AL30	AL40	AL40-06	AL50	AL60
				Lowest limit ON	Lowest limit OFF							
Polycarbonate	●	—	—	—	—	C1SL-3	C2SL-3	C3SL-3	C4SL-3			
	—	—	●	—	—	—	C2SL-C	—	—	—	—	—
	●	—	●	—	—	—	C2SL-3C	—	—	—	—	—
	●	●	—	—	—	—	—	C3SL-3W	C4SL-3W			
Nylon	—	—	—	—	—	C1SL-6	C2SL-6	C3SL-6	C4SL-6			
	●	—	—	—	—	C1SL-36	C2SL-36	C3SL-36	C4SL-36			
	—	—	●	—	—	—	C2SL-6C	—	—	—	—	—
	●	—	●	—	—	—	C2SL-36C	—	—	—	—	—
Metal	—	—	—	—	—	—	—	C3SL-36W	C4SL-36W			
	—	—	—	—	—	C1SL-2	C2SL-2	C3SL-2	C4SL-2			
	●	—	—	—	—	C1SL-23	C2SL-23	C3SL-23	C4SL-23			
Metal bowl with level gauge	—	—	—	—	—	—	—	C3LL-8	C4LL-8			
	●	—	—	—	—	—	—	C3LL-38	C4LL-38			
1000 cm ³ tank (Metal bowl with level gauge)	—	—	—	—	—	—	—	121538-1A				
	—	—	—	●	●	—	—	121538-1A-S1 [IS400-1 (Float switch only)]				
	—	—	—	—	—	—	—	121538-1A-S2 [IS400-2 (Float switch only)]				

Note) • Bowl O-ring (or seal) is included for the AL20 to AL60.

- Bowl assembly for the AL30 to AL60 models comes with a bowl guard (steel band material). (except when the bowl material is metal)
- Please consult SMC for psi and °F unit display specifications.
- When switching bowl materials from a polycarbonate or nylon product to a metal bowl with a level gauge, the oil feed tube assembly must be replaced. (Also, when switching bowl materials from a metal bowl with a level gauge to a polycarbonate or nylon product, the oil feed tube assembly must be replaced.) Please consult SMC separately.
- It is not possible to switch from a polycarbonate, nylon or metal bowl, or from a metal bowl with a level gauge to a 1000 cm³ tank. Please order the product separately.

AC

AF□

AR

AL

AW□

A□G

AV

AF800
AF900

Series AL10 to AL60

Flow Characteristics (Representative values)

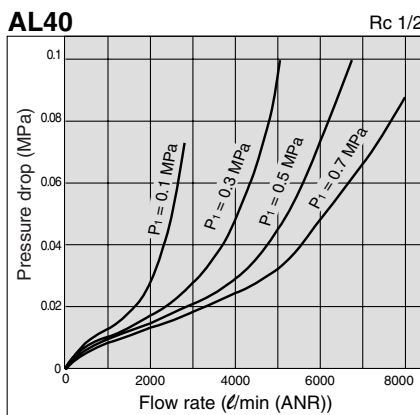
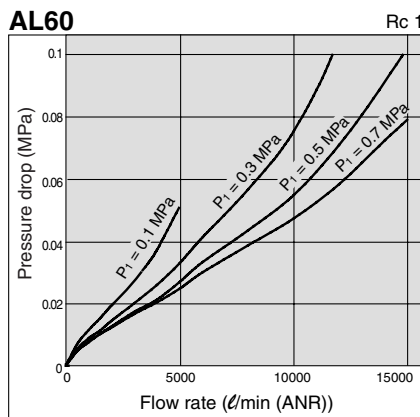
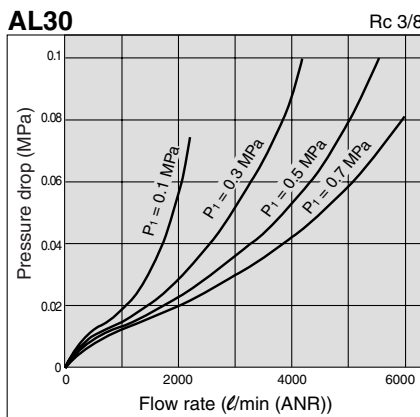
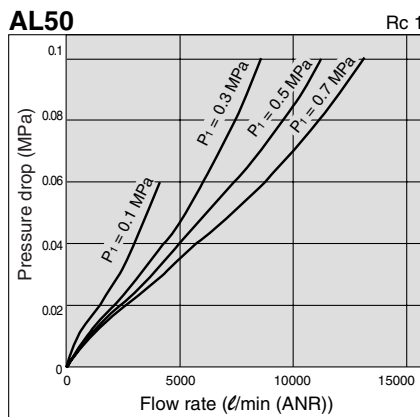
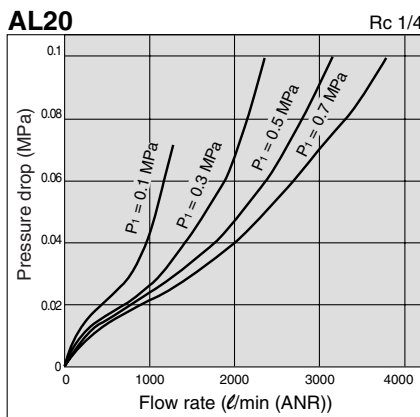
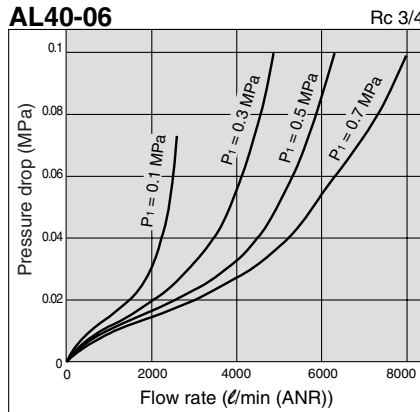
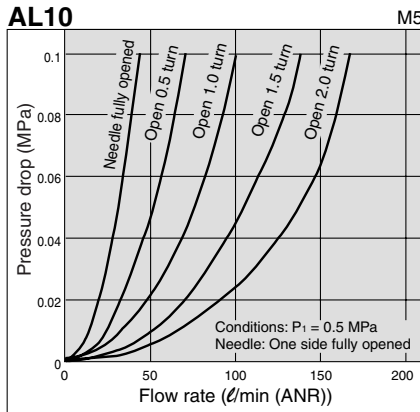

Working Principle: AL10 Type

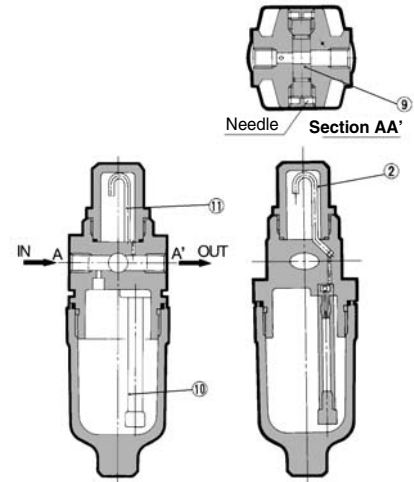

A portion of the air introduced from the IN side pressurizes the lubricant inside the bowl. The remainder of the air passes through the needles ⑨, and flows to the OUT side. The pressure differential between the inside of the bowl and the inside of the sight dome ②, causes the lubricant inside the bowl into the oil passage ⑩. The lubricant drips from the dripping tube ⑪, and lubricates the OUT side. The amount of lubricant is adjusted by the needle ⑨, on the front face. Turning the needle clockwise increases the amount of the lubricant, and turning it counterclockwise until fully opened shuts off the lubricant. The needle on the side that is not used should be left fully opened.

⚠ Specific Product Precautions

Be sure to read before handling. Refer to front matters 42 and 43 for Safety Instructions and pages 287 to 291 for F.R.L. Precautions.

Selection

⚠ Warning

1. Do not introduce air from the outlet side as this can damage the damper.

⚠ Caution

1. Use a check valve (AKM series) to prevent back flow of the lubricant when redirecting the air flow before the lubricator.

Maintenance

⚠ Warning

1. For the AL10/20 type, replenish the lubricant after releasing the inlet pressure. Lubrication cannot take place under a pressurized condition.
2. Adjustment of the oil regulating valve (sight dome assembly) for models from the AL20 to AL60 should be carried out manually. Turning it counterclockwise increases the dripping amount, and turning it clockwise reduces the dripping amount. The use of tools, etc. can result in damage to the unit. From the fully closed position, three rotations will bring it to the fully open position. Please do not rotate it any further than this. Note that the numbered scale markings are guidelines for adjusting the position, and not indicators of the dripping amount.

⚠ Caution

1. Check the dripping amount once a day. Drip failure can cause damage to the components that need lubrication.

Construction

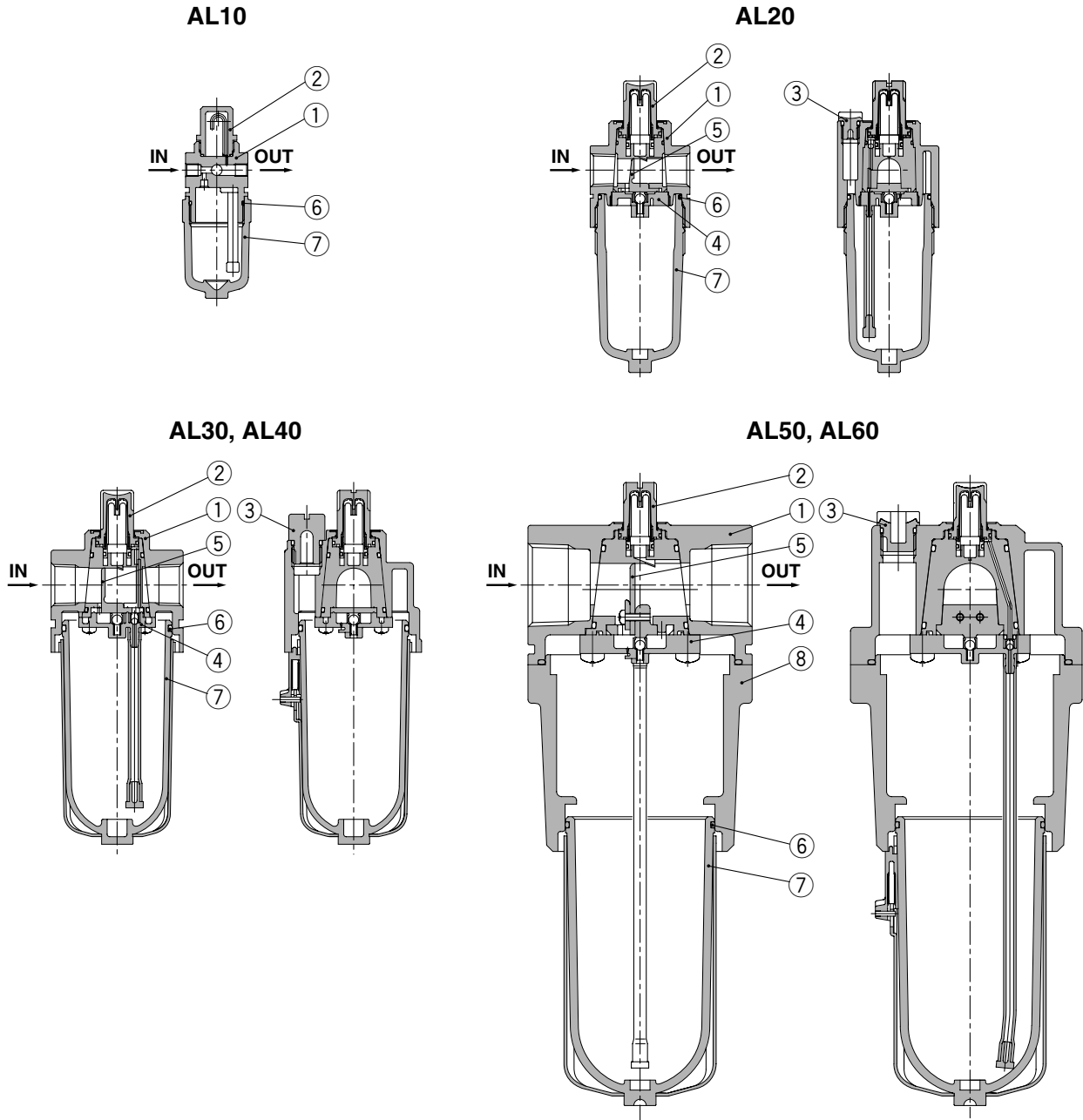

Component Parts

No.	Description	Material	Model	Color
1	Body	Zinc die-cast	AL10	Platinum silver
		Aluminum die-cast	AL20 to AL60	
8	Housing	Aluminum die-cast	AL50, AL60	Platinum silver

Replacement Parts

No.	Description	Material	Part no.						
			AL10	AL20	AL30	AL40	AL40-06	AL50	AL60
2	Sight dome assembly	Polycarbonate	AL10P-080AS	AL20P-080AS					
3	Lubrication plug assembly	—	—	AL20P-060AS	AL30P-060AS	AL40P-060AS			
4	Damper retainer assembly ^{Note 1)}	—	—	AL20P-030AS	AL30P-030AS	AL40P-030AS	AL50P-030AS	AL60P-030AS	
5	Damper (assembly)	Synthetic resin	—	AL20P-040S	AL30P-040S	AL40P-040S	AL50P-040AS	AL60P-040AS	
6	Bowl O-ring	NBR	C1SFP-260S	C2SFP-260S	C3SFP-260S	C4SFP-260S			
7	Bowl assembly ^{Note 2)}	Polycarbonate	C1SL	C2SL	C3SL ^{Note 3)}	C4SL ^{Note 3)}			

Note 1) Add "-1" at the end of the part number when ordering a damper retainer assembly for 1000 cm³. Example) AL30P-030AS-1

Note 2) Bowl O-ring is included for the AL20 to AL60. Please contact SMC regarding the bowl assembly supply for psi and °F unit specifications.

Note 3) Bowl assembly for the AL30 to AL60 models comes with a bowl guard (steel band material).

AC

AF□

AR

AL

AW□

A□G

AV

AF800
AF900

Series AL10 to AL60

Dimensions

AL10

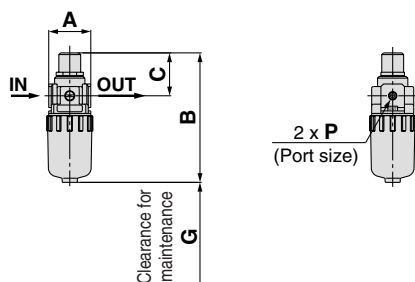

AL20

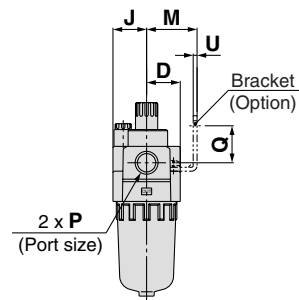
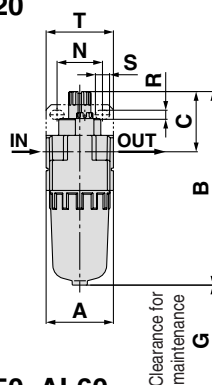

AL30, AL40

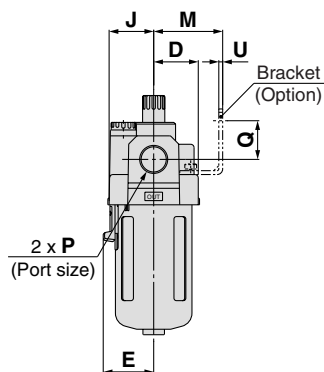
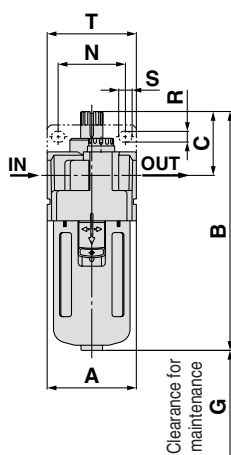

AL50, AL60

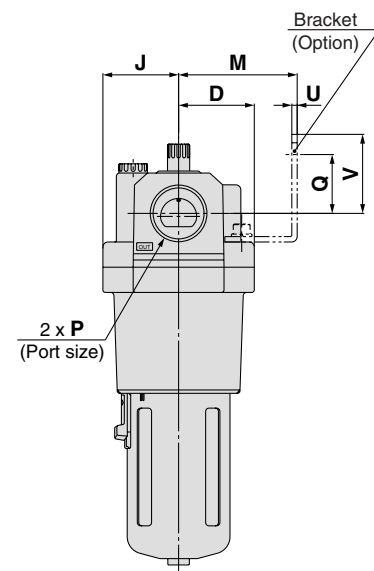
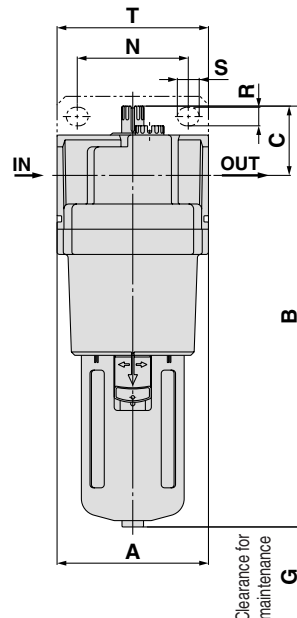

Applicable model Optional/Semi-standard specifications	AL10/20				AL30 to AL60				
	With drain cock	Metal bowl with drain cock	Metal bowl	With drain cock	Metal bowl with level gauge	Metal bowl with drain cock	Metal bowl with drain cock & level gauge	Drain cock with barb fitting	
Dimensions									

Model	Standard specifications								Optional specifications						
	P	A	B	C	D	E	G	J	M	N	Q	R	S	T	U
AL10	M5 x 0.8	25	77	26	12.5	—	35	12.5	—	—	—	—	—	—	—
AL20	1/8, 1/4	40	115	36	20	—	60	20	30	27	22	5.4	8.4	40	2.3
AL30	1/4, 3/8	53	142	38	26.5	30	80	26.5	41	40	23	6.5	8	53	2.3
AL40	1/4, 3/8, 1/2	70	176	40	35	38	110	35	50	54	26	8.5	10.5	70	2.3
AL40-06	3/4	75	176	38	35	38	110	35	50	54	25	8.5	10.5	70	2.3
AL50	3/4, 1	90	250	41	45	45	110	45	70	66	35	11	13	90	3.2
AL60	1	95	268	45	47.5	—	110	47.5	70	66	35	11	13	90	3.2

Model	Semi-standard specifications					
	With drain cock	With barb fitting	Metal bowl	Metal bowl with drain cock	Metal bowl with level gauge	Metal bowl with drain cock & level gauge
	B	B	B	B	B	B
AL10	85	—	82	85	—	—
AL20	123	—	121	124	—	—
AL30	153	161	142	166	162	186
AL40	187	195	176	200	196	220
AL40-06	187	195	176	200	196	220
AL50	261	269	250	274	270	294
AL60	279	287	268	292	288	312

Dimensions

Semi-standard specifications: 1000 cm³ tank

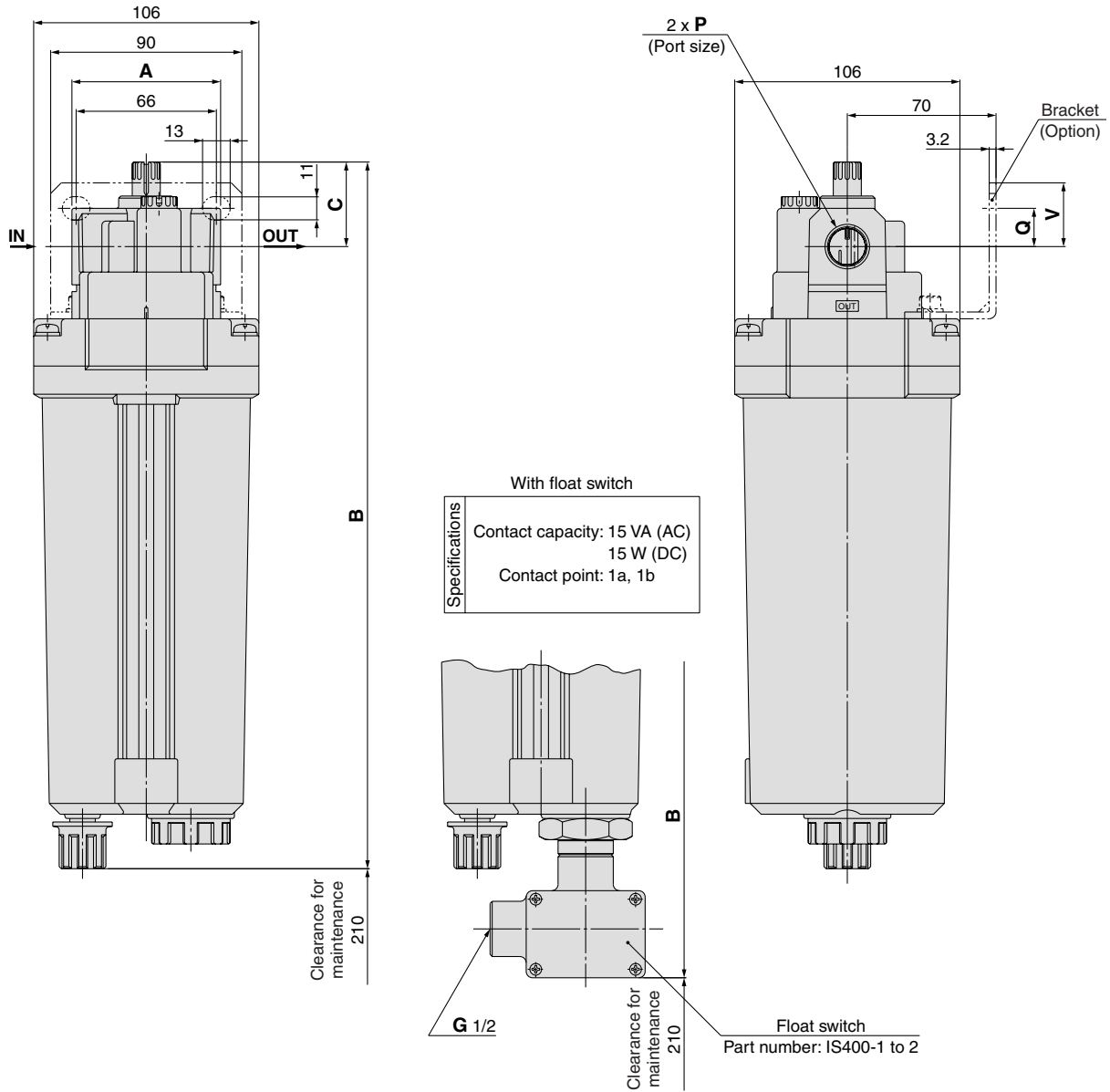

Model	P	A	B	C	Bracket mount		With float switch
					Q	V	B
AL30	1/4, 3/8	53	324	38	25	—	374
AL40	1/4, 3/8, 1/2	70	333	40	18	—	383
AL40-06	3/4	75	333	38	16	—	383
AL50	3/4, 1	90	332	41	35	47	382
AL60	1	95	335	45	35	47	385

AC

AF□

AR

AL





AW□

A□G

AV

AF800
AF900

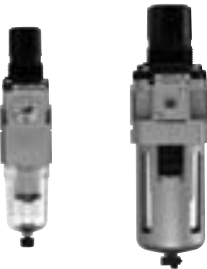
Modular Type Filter Regulators Series AW

Filter Regulator Series AW	Model	Port size	Options
 <p>Pages 366 through to 377</p>	AW10	M5 x 0.8	Bracket Float type auto drain Square embedded type pressure gauge (except the AW10) Round type pressure gauge Digital pressure switch (except the AW10) Panel mount
	AW20	1/8, 1/4	
	AW30	1/4, 3/8	
	AW40	1/4, 3/8, 1/2	
	AW40-06	3/4	
	AW60	3/4, 1	
 <p>Pages 366 through to 377</p>	AW20K	1/8, 1/4	
	AW30K	1/4, 3/8	
	AW40K	1/4, 3/8, 1/2	
	AW40K-06	3/4	
	AW60K	3/4, 1	
 <p>Pages 378 through to 387</p>	AWM20	1/8, 1/4	
	AWM30	1/4, 3/8	
	AWM40	1/4, 3/8, 1/2	
 <p>Pages 378 through to 387</p>	AWD20	1/8, 1/4	
	AWD30	1/4, 3/8	
	AWD40	1/4, 3/8, 1/2	

AC

AF□

AR

AL

AW□

A□G

AV

AF800
AF900

Filter Regulator

AW10 to AW60

Filter Regulator with Backflow Function

AW20K to AW60K

JIS Symbol
Filter Regulator

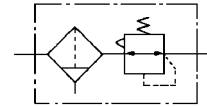

Filter Regulator with
Backflow Function

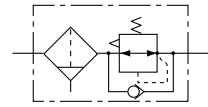

- Integrated filter and regulator units save space and require less piping.
- With the backflow function it incorporates a mechanism to exhaust the air pressure in the outlet side reliably and quickly.

Example)

When the air supply is cut off and releasing the inlet pressure to the atmosphere, the residual pressure release of the outlet side can be ensured for a safety purpose.

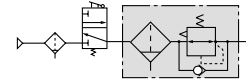

How to Order

AW **30** **K** - **03** **BE** - **1N**

① ② ③ ④ ⑤ ⑥

• Made to Order

Refer to pages 374 through to 377 for details.

- Option/Semi-standard: Select one each for a to i.
 - Option/Semi-standard symbol: When more than one specification is required, indicate in alphanumeric order.
- Example) AW30K-03BE-1N

	Symbol	Description	① Body size					
			10	20	30	40	60	
② With backflow function	Nil	Without backflow function	●	●	●	●	●	
	K ^{Note 1)}	With backflow function	—	●	●	●	●	
③ Thread type	Nil	Metric thread (M5)	●	—	—	—	—	
	Rc		—	●	●	●	●	
	N ^{Note 2)}	NPT	—	●	●	●	●	
	F ^{Note 3)}	G	—	●	●	●	●	
④ Port size	M5	M5	●	—	—	—	—	
	01	1/8	—	●	—	—	—	
	02	1/4	—	●	●	—	—	
	03	3/8	—	—	●	●	—	
	04	1/2	—	—	—	●	—	
	06	3/4	—	—	—	●	●	
	10	1	—	—	—	—	●	
⑤ Option	a Mounting	Nil	Without mounting option	●	●	●	●	●
		B ^{Note 5)}	With bracket	●	●	●	●	●
		H	With set nut (for panel fitting)	●	●	●	●	—
	b Float type auto drain	Nil	Without auto drain	●	●	●	●	●
		C	Float type auto drain (N.C.)	●	●	●	●	●
		D	Float type auto drain (N.O.)	—	—	●	●	●
	c Pressure gauge	Nil	Without pressure gauge	●	●	●	●	●
		E	Square embedded type pressure gauge (with limit indicator)	—	●	●	●	●
		G	Round type pressure gauge (without limit indicator)	●	—	—	—	—
Round type pressure gauge (with limit indicator)			—	●	●	●	●	
M		Round type pressure gauge (with color zone)	—	●	●	●	●	
Digital pressure switch		E1 ^{Note 6)}	Output: NPN output / Electrical entry: Wiring bottom entry	—	●	●	●	●
		E2 ^{Note 6)}	Output: NPN output / Electrical entry: Wiring top entry	—	●	●	●	●
	E3 ^{Note 6)}	Output: PNP output / Electrical entry: Wiring bottom entry	—	●	●	●	●	
	E4 ^{Note 6)}	Output: PNP output / Electrical entry: Wiring top entry	—	●	●	●	●	
⑥ Semi-standard	d Set pressure	Nil ^{Note 7)}	0.05 to 0.85 MPa setting	●	●	●	●	●
		1 ^{Note 8)}	0.02 to 0.2 MPa setting	●	●	●	●	●
	e Bowl ^{Note 9)}	Nil	Polycarbonate bowl	●	●	●	●	●
		2	Metal bowl	●	●	●	●	●
		6	Nylon bowl	●	●	●	●	●
8		Metal bowl with level gauge	—	—	●	●	●	
C		With bowl guard	—	●	—	—	—	
6C	Nylon bowl with bowl guard	—	●	—	—	—		

Filter Regulator *Series AW10 to AW60*

Filter Regulator with Backflow Function *Series AW20K to AW60K*



AW20, AW20K AW40, AW40K

		Symbol	Description	①					
				Body size					
				10	20	30	40	60	
6	Semi-standard	f	Drain port ^{Note 10)}	Nil	With drain cock				
				J ^{Note 11)}	Drain guide 1/8				
					Drain guide 1/4				
				W ^{Note 12)}	Drain cock with barb fitting: For ø6 x ø4 nylon tube				
	+				●	●	●	●	●
	g	Exhaust mechanism	Nil	Relieving type					
			N	Non-relieving type					
	+				●	●	●	●	●
	h	Flow direction	Nil	Flow direction: Left to right					
			R	Flow direction: Right to left					
+				●	●	●	●	●	
i	Pressure unit	Nil	Name plate, caution plate for bowl, and pressure gauge in imperial units: MPa						
		Z ^{Note 13)}	Name plate, caution plate for bowl, and pressure gauge in imperial units: psi, °F						
		ZA ^{Note 14)}	Digital pressure switch: With unit conversion function						
				○ Note 15)	○ Note 15)	○ Note 15)	○ Note 15)	○ Note 15)	
				—	△ Note 16)	△ Note 16)	△ Note 16)	△ Note 16)	

- Note 1) The AW10 type comes with a backflow function as a standard feature. (K is not available.) When using the AW10 type as w/ backflow function, backflow may not occur with the set pressure 0.15 MPa or less. Please set the inlet pressure to at least 0.05 MPa higher than the set pressure.
- Note 2) Drain guide is NPT 1/8 (applicable to the AW20(K)) and NPT 1/4 (applicable to the AW30(K) to AW60(K)). The auto drain port comes with ø3/8" one-touch fitting (applicable to the AW30(K) to AW60(K)).
- Note 3) Drain guide is G 1/8 (applicable to the AW20(K)) and G 1/4 (applicable to the AW30(K) to AW60(K)).
- Note 4) Option B, G, H, M are not assembled and supplied loose at the time of shipment.
- Note 5) Assembly of a bracket and set nuts (AW10,

- AW20(K) to AW40(K)) Including 2 mounting screws for the AW60(K)
- Note 6) When choosing with H (panel mount), the installation space for lead wires will not be secured. In this case, select "wiring top entry" for the electrical entry.
- Note 7) Only the AW10 has a pressure setting of 0.05 to 0.7 MPa.
- Note 8) The only difference from the standard specifications is the adjusting spring for the regulator. It does not restrict the setting of 0.2 MPa or more. When the pressure gauge is attached, a 0.2 MPa pressure gauge will be fitted.
- Note 9) Refer to Chemical Data on page 287 when selecting a case material.
- Note 10) Float type auto drain: The combination of C and D is not possible.
- Note 11) Without a valve function

- Note 12) Metal bowl: The combination of 2 and 8 is not possible.
- Note 13) For thread type: M5 and NPT. This product is for overseas use only according to the new Measurement Law. (The SI unit type is provided for use in Japan.) The digital pressure switch will be equipped with the unit conversion function, setting to psi initially. The combination of the round type pressure gauge with color zone "M" and a psi display "Z" is not orderable as a standard product. However, this combination is available as a special.
- Note 14) For options: E1, E2, E3, E4. This product is for overseas use only according to the new Measurement Law. (The SI unit is provided for use in Japan.)
- Note 15) ○: For thread type: M5 and NPT only
- Note 16) △: Select with options: E1, E2, E3, E4.

Standard Specifications

Model	AW10	AW20(K)	AW30(K)	AW40(K)	AW40(K)-06	AW60(K)
Port size	M5 x 0.8	1/8, 1/4	1/4, 3/8	1/4, 3/8, 1/2	3/4	3/4, 1
Pressure gauge port size ^{Note 1)}	1/16 ^{Note 2)}	1/8		1/4		
Fluid	Air					
Ambient and fluid temperature ^{Note 3)}	-5 to 60°C (with no freezing)					
Proof pressure	1.5 MPa					
Maximum operating pressure	1.0 MPa					
Set pressure range	0.05 to 0.7 MPa		0.05 to 0.85 MPa			
Relief pressure ^{Note 4)}	Set pressure + 0.05 MPa [at relief flow rate of 0.1 ℓ/min (ANR)]					
Nominal filtration rating	5 μm					
Drain capacity (cm³)	2.5	8	25	45	45	45
Bowl material	Polycarbonate					
Bowl guard	—	Semi-standard	Standard			
Construction	Relieving type					
Mass (kg)	0.09	0.20	0.40	0.72	0.75	2.00

Note 1) Pressure gauge connection threads are not available for F.R.L. unit with a square embedded type pressure gauge (AW20(K) to AW60(K)).

Note 3) -5 to 50°C for the products with the digital pressure switch
 Note 4) Not applicable to the AW10.

Note 2) Use a bushing (part no:131368) when connecting the R1/8 pressure gauge to the Rc 1/16.



- AC
- AF□
- AR
- AL
- AW□
- A□G
- AV
- AF800
- AF900

Series AW10 to AW60

Series AW20K to AW60K

Options/Part No.

Optional specifications			Model						
			AW10(K)	AW20(K)	AW30(K)	AW40(K)	AW40(K)-06	AW60(K)	
Bracket assembly ^{Note 1)}			AR10P-270AS	AW20P-270AS	AR30P-270AS	AR40P-270AS		AW60P-270AS ^{Note 6)}	
Set nut			AR10P-260S	AR20P-260S	AR30P-260S	AR40P-260S		— ^{Note 7)}	
Pressure gauge	Round type ^{Note 2)}	Standard	G27-10-R1	G36-10-□01		G46-10-□02			
		0.02 to 0.2 MPa setting	G27-10-R1 ^{Note 3)}	G36-2-□01		G46-2-□02			
	Round type (with color zone) ^{Note 2)}	Standard	—	G36-10-□01-L		G46-10-□02-L			
		0.02 to 0.2 MPa setting	—	G36-2-□01-L		G46-2-□02-L			
	Square embedded type ^{Note 4)}	Standard	—	GC3-10AS [GC3P-010AS (Pressure gauge cover only)]					
		0.02 to 0.2 MPa setting	—	GC3-2AS [GC3P-010AS (Pressure gauge cover only)]					
Digital pressure switch ^{Note 5)}	NPN output / Wiring bottom entry		—	ISE35-N-25-MLA [ISE35-N-25-M (Switch body only)]					
	NPN output / Wiring top entry			ISE35-R-25-MLA [ISE35-R-25-M (Switch body only)]					
	PNP output / Wiring bottom entry			ISE35-N-65-MLA [ISE35-N-65-M (Switch body only)]					
	PNP output / Wiring top entry			ISE35-R-65-MLA [ISE35-R-65-M (Switch body only)]					
Float type auto drain ^{Note 8) Note 9)}			N.C.	AD17	AD27	AD37	AD47		
			N.O.	—	—	AD38	AD48		

Semi-standard/Bowl Assembly Part No.

Semi-standard specifications						Model					
Bowl material	^{Note 8) Note 9)} Float type auto drain		^{Note 9)} With drain guide	With barb fitting	With bowl guard	AW10(K)	AW20(K)	AW30(K)	AW40(K)	AW40(K)-06	AW60(K)
	N.C.	N.O.									
Polycarbonate	—	—	—	—	●	—	C2SF-C	—	—		
	●	—	—	—	●	—	AD27-C	—	—		
	—	—	●	—	—	—	C2SF-J	C3SF-J	C4SF-J		
	—	—	●	●	—	—	—	C3SF-W	C4SF-W		
	—	—	●	—	●	—	C2SF-CJ	—	—		
Nylon	—	—	—	—	—	C1SF-6	C2SF-6	C3SF-6	C4SF-6		
	—	—	—	—	●	—	C2SF-6C	—	—		
	●	—	—	—	—	AD17-6	AD27-6	AD37-6	AD47-6		
	—	●	—	—	—	—	—	AD38-6	AD48-6		
	●	—	—	—	●	—	AD27-6C	—	—		
	—	—	●	—	—	—	C2SF-6J	C3SF-6J	C4SF-6J		
	—	—	—	●	—	—	—	C3SF-6W	C4SF-6W		
	—	—	●	—	●	—	C2SF-6CJ	—	—		
Metal	—	—	—	—	—	C1SF-2	C2SF-2	C3SF-2	C4SF-2		
	●	—	—	—	—	AD17-2	AD27-2	AD37-2	AD47-2		
	—	●	—	—	—	—	—	AD38-2	AD48-2		
	—	—	●	—	—	—	C2SF-2J	C3SF-2J	C4SF-2J		
Metal bowl with level gauge	—	—	—	—	—	—	—	C3LF-8	C4LF-8		
	●	—	—	—	—	—	—	AD37-8	AD47-8		
	—	●	—	—	—	—	—	AD38-8	AD48-8		
	—	—	●	—	—	—	—	C3LF-8J	C4LF-8J		

Note 1) Assembly of a bracket and set nuts

Note 2) □ in part numbers for a round pressure gauge indicates a type of connection thread. No indication is necessary for R; however, indicate N for NPT. Please contact SMC regarding the connection thread NPT and pressure gauge supply for psi unit specifications.

Note 3) Standard pressure gauge

Note 4) Including one O-ring and 2 mounting screws. []: Pressure gauge cover only

Note 5) Lead wire with connector (2 m), adapter, lock pin, O-ring (1 pc.), mounting screw (2 pcs.) are attached. []: Switch body only. Also, regarding how to order the digital pressure switch, please refer to page 388. A pressure switch adapter assembly (AW60P-310AS) will be additionally required for the AW60(K) only. Use the attached mounting screw (M3 x 0.5 x 14) for mounting. The mounting screw (M3 x 0.5 x 7) attached to the digital pressure switch assembly will not be required.

Note 6) Assembly of a bracket and 2 mounting screws

Note 7) Please consult SMC regarding the set nuts for the AW60(K).

Note 8) Minimum operating pressure: N.O. type—0.1 MPa; N.C. type—0.1 MPa (AD27) and 0.15 MPa (AD37/47). Please contact SMC for psi and °F unit specifications.

Note 9) Please consult SMC for details on drain piping to fit NPT or G port sizes.

Note) • Bowl O-ring is included for the AW20(K) to AW60(K).

• Bowl assembly for the AW30(K) to AW60(K) models comes with a bowl guard (steel band material). (except when the bowl material is metal)



Series AW10 to AW60 Series AW20K to AW60K Specific Product Precautions

Be sure to read before handling. Refer to front matters 42 and 43 for Safety Instructions and pages 287 to 291 for F.R.L. Precautions.

Selection

Warning

1. Residual pressure disposal (outlet pressure removal) is not possible for the AW20 to AW60 even though the inlet pressure is exhausted. When the residual pressure disposal is performed, use the filter regulator with backflow function (AW20K to AW60K).

Maintenance

Warning

1. Replace the element every 2 years or when the pressure drop becomes 0.1 MPa, whichever comes first, to prevent damage to the element.

Mounting and Adjustment

Warning

1. Set the regulator while verifying the displayed values of the inlet and outlet pressure gauges. Turning the regulator knob excessively can cause damage to the internal parts.
2. The pressure gauge included with regulators for 0.02 to 0.2 MPa setting is for up to 0.2 MPa use only (except the AW10). Exceeding 0.2 MPa of pressure can damage the gauge.
3. Do not use tools on the pressure regulator knob as this may cause damage. It must be operated manually.

Caution

1. Be sure to unlock the knob before adjusting the pressure and lock it after setting the pressure. Failure to follow this procedure can cause damage to the knob and the outlet pressure may fluctuate.
 - Pull the pressure regulator knob to unlock. (You can visually verify this with the "orange mark" that appears in the gap.)
 - Push the pressure regulator knob to lock. When the knob is not easily locked, turn it left and right a little and then push it (when the knob is locked, the "orange mark", i.e., the gap will disappear).

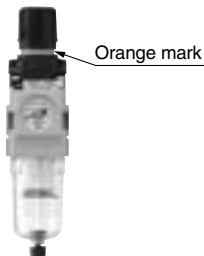

2. A knob cover is available to prevent careless operation of the knob. Refer to page 389 for details.

AC

AF□

AR

AL

AW□

A□G

AV

AF800
AF900

Series AW10 to AW60

Series AW20K to AW60K

Flow Characteristics (Representative values)

Condition: Inlet pressure 0.7 MPa

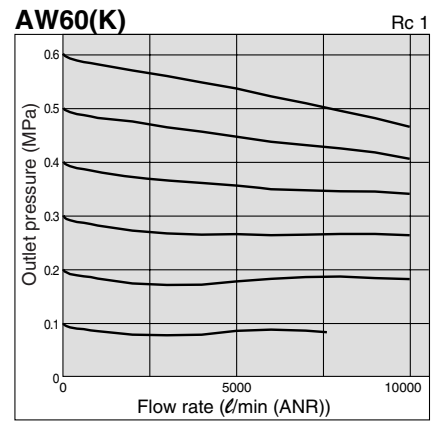
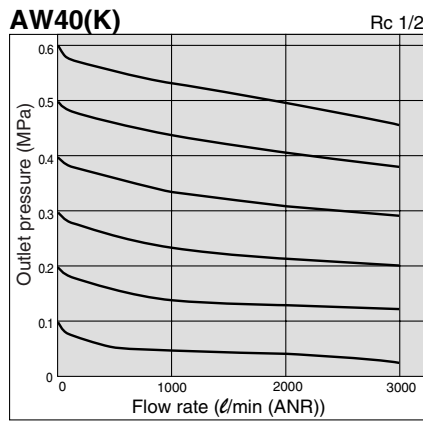
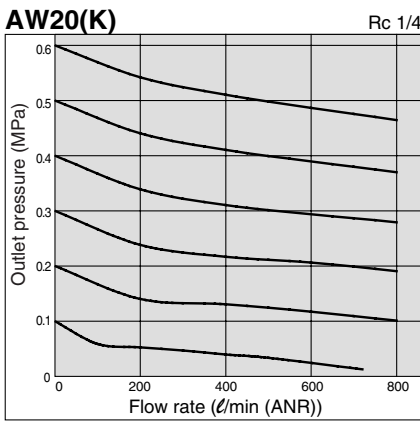
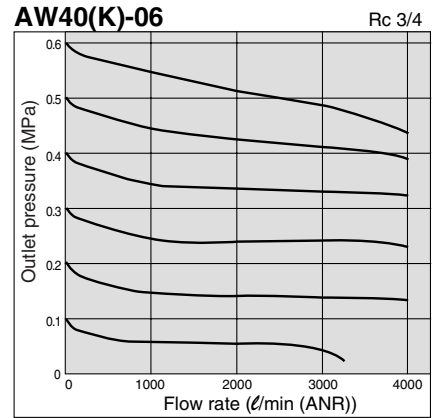
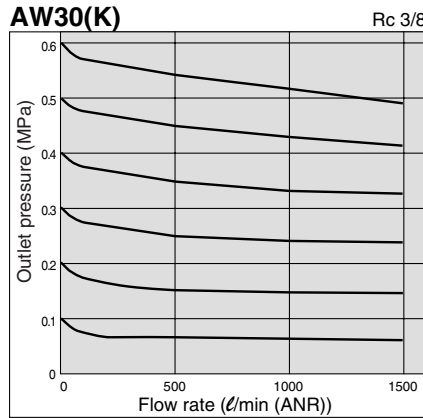
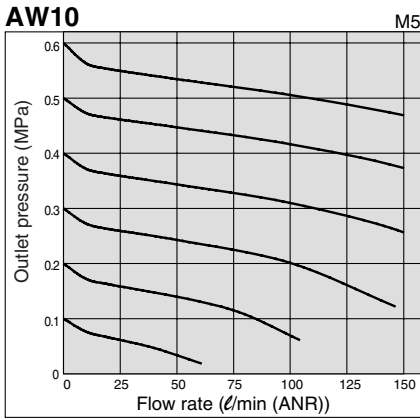

Pressure Characteristics (Representative values)

Conditions: Inlet pressure 0.7 MPa, Outlet pressure 0.2 MPa, Flow rate 20 l/min (ANR)

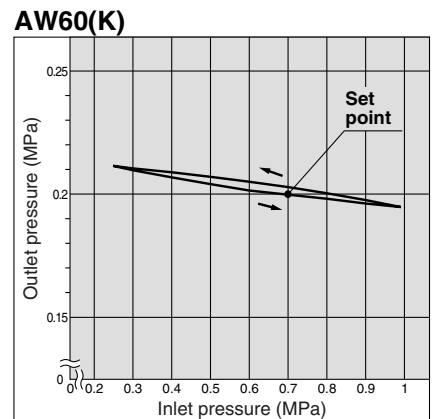
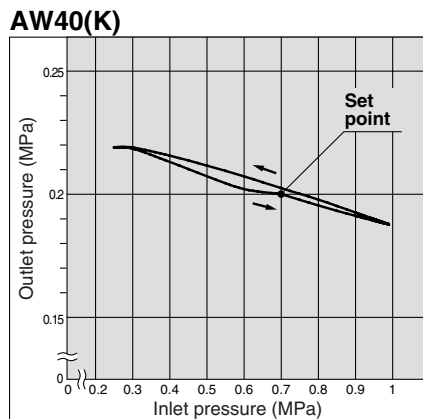
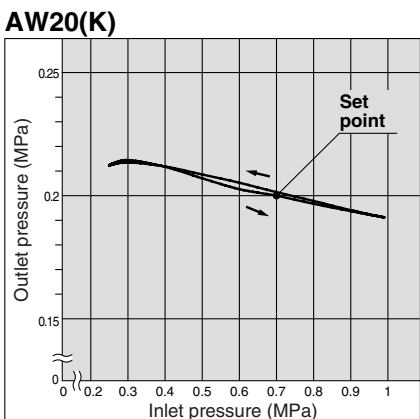
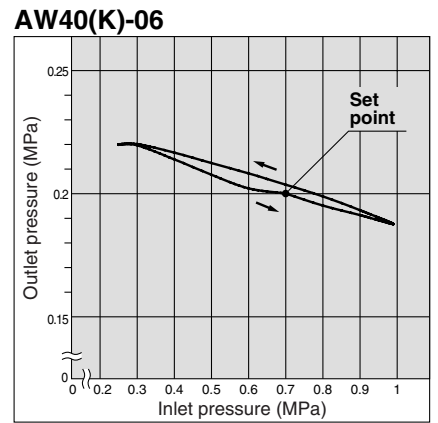
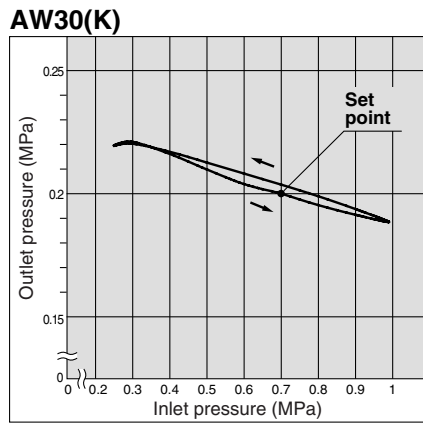
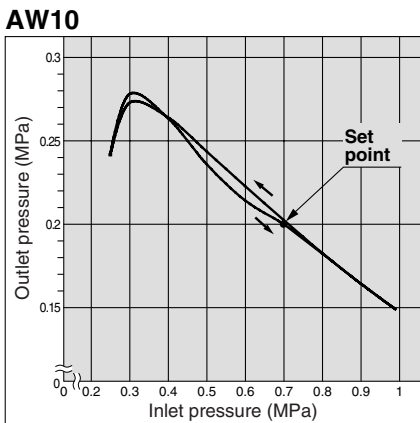

Filter Regulator *Series AW10 to AW60*

Filter Regulator with Backflow Function *Series AW20K to AW60K*

Construction

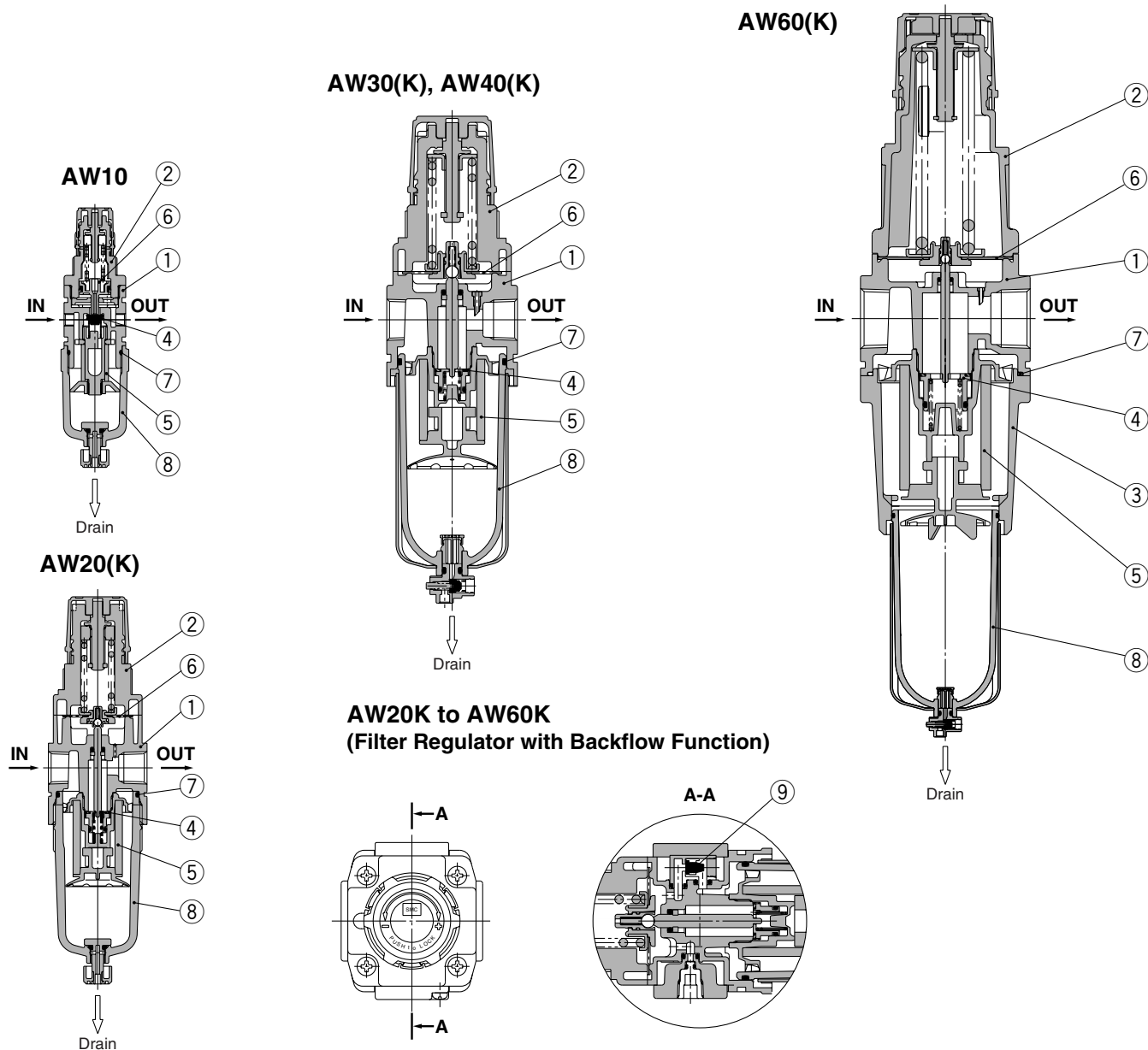

Component Parts

No.	Description	Material	Model	Color
1	Body	Zinc die-cast	AW10	Platinum silver
		Aluminum die-cast	AW20(K) to AW60(K)	
2	Bonnet	Polyacetal	AW10 to AW40(K)	Black
		Aluminum die-cast	AW60(K)	
3	Housing	Aluminum die-cast	AW60(K)	Platinum silver

Replacement Parts

No.	Description	Material	Part no.					
			AW10	AW20(K)	AW30(K)	AW40(K)	AW40(K)-06	AW60(K)
4	Valve assembly	Brass, HNBR	AR10P-090S	AW20P-340AS	AW30P-340AS	AW40P-340AS		AW60P-090AS
5	Filter element	Non-woven fabric	AF10P-060S	AF20P-060S	AF30P-060S	AF40P-060S		AW60P-060S
6	Diaphragm assembly	Weatherable NBR	AR10P-150AS ^{Note 1)}	AR20P-150AS	AR30P-150AS	AR40P-150AS		AR50P-150AS
7	Bowl O-ring	NBR	C1SFP-260S	C2SFP-260S	C3SFP-260S	C4SFP-260S		
8	Bowl assembly ^{Note 2)}	Polycarbonate	C1SF	C2SF	C3SF ^{Note 3)}	C4SF ^{Note 3)}		
9	Check valve assembly ^{Note 4)}	—	—	AR20KP-020AS				

Note 1) The AW10 is a piston type. Assembly of a piston and a seal (KSY-P-13).

Note 2) Bowl O-ring is included for the AW20(K) to AW60(K). Please contact SMC regarding the bowl assembly supply for psi and °F unit specifications.

Note 3) Bowl assembly for the AW30(K) to AW60(K) models comes with a bowl guard (steel band material).

Note 4) Check valve assembly is applicable for a filter regulator with backflow function (AW20K to AW60K) only.

Assembly of a check valve cover, check valve body assembly and 2 screws

AC

AF□

AR

AL

AW□

A□G

AV

AF800
AF900

Series AW10 to AW60

Series AW20K to AW60K

Working Principle (Filter Regulator with Backflow Function)

AW10

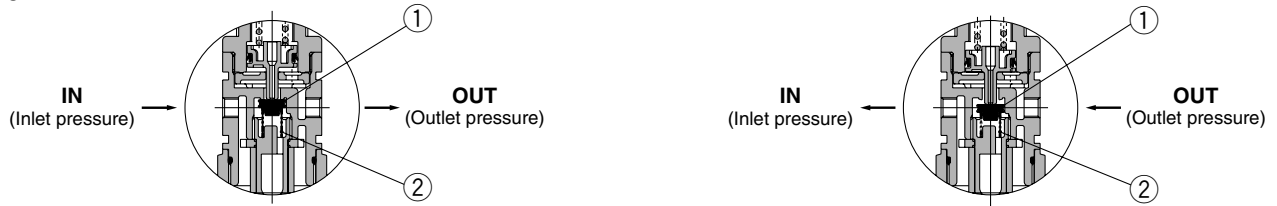

When the inlet pressure is higher than the regulating pressure, the check valve operates as a normal regulator (Figure 1).

When the inlet pressure is shut off and exhausted, any inlet pressure applied to the valve ① will be lost. The force for seating the valve ① is the valve spring force ② only. When the valve ① is opened using the outlet force, the outlet pressure will be exhausted at the inlet side. (Figure 2)

When the set pressure is 0.15 MPa or less, valve ① may not open due to the valve spring ② force.

AW20K to AW60K

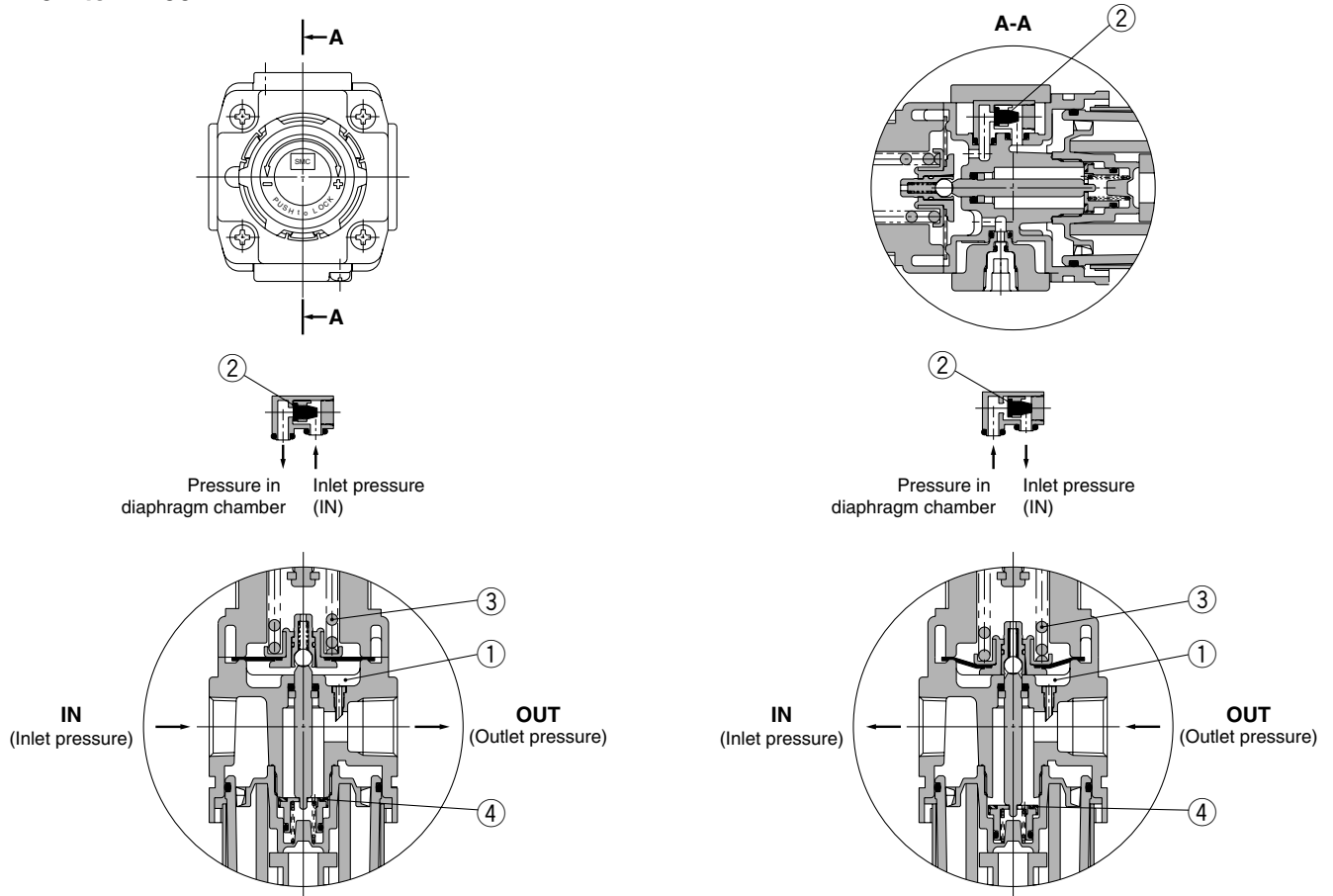

Figure 1 Normal

Figure 2 Backflow

When the inlet pressure is higher than the regulating pressure, the check valve ② closes and operates as a normal regulator (Figure 1). When the inlet pressure is shut off and released, the check valve ② opens and the pressure in the diaphragm chamber ① is released into the inlet side (Figure 2).

This lowers the pressure in the diaphragm chamber ① and the force generated by the pressure regulator spring ③ lifts the diaphragm. Valve ④ opens through the stem, and the outlet pressure is released to the inlet side (Figure 2).

Filter Regulator *Series AW10 to AW60*

Filter Regulator with Backflow Function *Series AW20K to AW60K*

Dimensions

AW10, AW20(K)

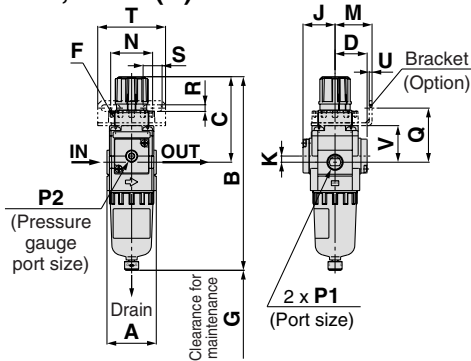

Panel fitting dimension

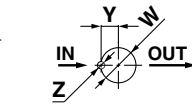
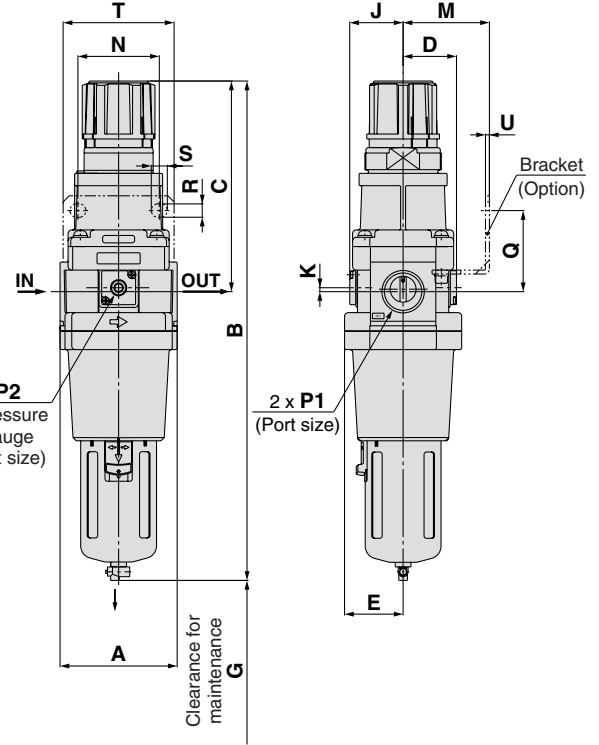
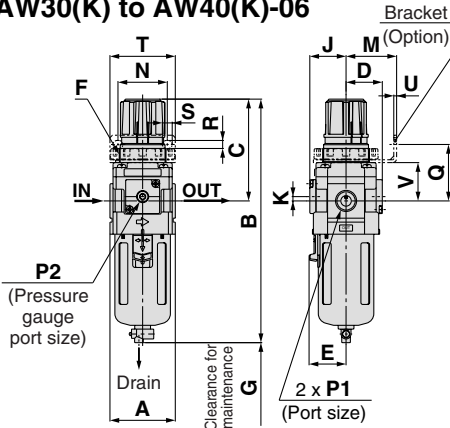

Plate thickness
AW10, AW20(K): Max. 3.5

AW60(K)



AW30(K) to AW40(K)-06



Panel fitting dimension

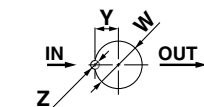

Plate thickness
AW30(K): Max. 3.5
AW40(K): Max. 5

Applicable model	AW20(K) to AW60(K)		AW10, AW20(K) to AW60(K)	AW20(K) to AW60(K)
Option	Square embedded type pressure gauge	Digital pressure switch	Round type pressure gauge	Round type pressure gauge (with color zone)
Dimensions				

Applicable model	AW10, AW20(K)		AW20(K)	AW30(K) to AW60(K)				
Optional/Semi-standard specifications	With auto drain (N.C.)	Metal bowl	With drain guide	With auto drain (N.O./N.C.)	Metal bowl	Metal bowl with level gauge	With drain guide	Drain cock with barb fitting
Dimensions								

Model	Standard specifications											Optional specifications							
	P1	P2	A	B (Note)	C	D	E	F	G	J	K	H	J	H	J	H	J	H	J
AW10	M5 x 0.8	1/16	25	108	48	12.5	—	M18 x 1	25	13	0	—	—	—	—	ø26	26	—	—
AW20(K)	1/8, 1/4	1/8	40	160	73	26	—	M28 x 1	40	26	5	□28	27	□27.8	37.5	ø37.5	63	ø37.5	63
AW30(K)	1/4, 3/8	1/8	53	201	86	29.5	30	M38 x 1.5	55	29.5	3.5	□28	30.5	□27.8	41	ø37.5	66	ø37.5	66
AW40(K)	1/4, 3/8, 1/2	1/4	70	239	92	37.5	38	M42 x 1.5	80	37.5	1.5	□28	38.5	□27.8	49	ø42.5	76	ø42.5	76
AW40(K)-06	3/4	1/4	75	242	93	37.5	38	M42 x 1.5	80	37.5	1.2	□28	38.5	□27.8	49	ø42.5	76	ø42.5	76
AW60(K)	3/4, 1	1/4	95	409	175	43.5	47.5	—	20	43.5	3.2	□28	44.5	□27.8	61.5	ø42.5	84	ø42.5	84

Model	Optional specifications											Semi-standard specifications				
	Bracket mount					Panel mount						With auto drain	With barb fitting	With drain guide	Metal bowl	Metal bowl with level gauge
	M	N	Q	R	S	T	U	V	W	Y	Z	B (Note)	B (Note)	B (Note)	B (Note)	B (Note)
AW10	25	28	30	4.5	6.5	40	2	18	18.5	—	—	125	—	—	107	—
AW20(K)	30	34	44	5.4	15.4	55	2.3	30	28.5	14	6	177	—	164	160	—
AW30(K)	41	40	46	6.5	8	53	2.3	31	38.5	19	7	242	209	208	214	234
AW40(K)	50	54	54	8.5	10.5	70	2.3	35.5	42.5	21	7	278	247	246	252	272
AW40(K)-06	50	54	56	8.5	10.5	70	2.3	37	42.5	21	7	282	251	249	255	275
AW60(K)	70	66	66	11	13	90	3.2	—	—	—	—	448	417	416	422	442

Note) The total length of B dimension is the length when the filter regulator knob is unlocked.

- AC
- AF□
- AR
- AL
- AW□
- A□G
- AV
- AF800
- AF900

Filter Regulator AW20 to AW60

Made to Order Specifications:



Please contact SMC for detailed dimensions, specifications, and lead times.

① Special Temperature Environment

Special materials are used in the manufacturing of seals and resin parts to allow them to withstand various temperature conditions in cold or tropical (hot) climates.

Specifications

Made-to-order part no.	-X430	-X440
Environment	Low temperature	High temperature
Ambient temperature (°C)	-30 to 60	-5 to 80
Fluid temperature (°C)	-5 to 60 (with no freezing)	
Material	Rubber parts	Special NBR
	Main parts	Metal (Aluminum die-cast), etc.



AW30-03G-2-X440

Applicable Model

Model	AW30	AW40	AW40-06	AW60
Port size	1/4, 3/8	1/4, 3/8, 1/2	3/4	3/4, 1

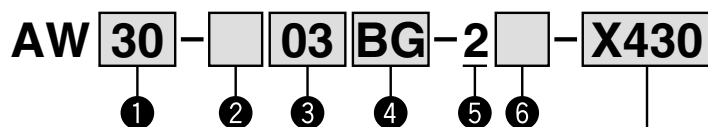

For high/low temperature

X430	Low temperature
X440	High temperature

- Option/Semi-standard: Select one each for a to g.
 - Option/Semi-standard symbol: When more than one specification is required, indicate in alphanumeric order.
- Example) AW30-03BG-2N-X430

	Symbol	Description	① Body size			
			30	40	60	
② Thread type	Nil	Rc	●	●	●	
	N	NPT	●	●	●	
	F	G	●	●	●	
	+					
③ Port size	02	1/4	●	●	—	
	03	3/8	●	●	—	
	04	1/2	—	●	—	
	06	3/4	—	●	●	
	10	1	—	—	●	
④ Option	a Mounting	Nil	Without mounting option	●	●	●
		B	With bracket	●	●	●
		H	With set nut (for panel fitting)	●	●	—
	+					
b Pressure gauge	Nil	Without pressure gauge	●	●	●	
	G	Round type pressure gauge (without limit indicator)	●	●	●	
+						
⑤ Bowl	2	Metal bowl	●	●	●	
+						
⑥ Semi-standard	c Set pressure	Nil	0.05 to 0.85 MPa setting	●	●	●
		1	0.02 to 0.2 MPa setting	●	●	●
	+					
	d Drain port	Nil	With drain cock	●	●	●
J		Drain guide 1/4	●	●	●	
+						
e Exhaust mechanism	Nil	Relieving type	●	●	●	
	N	Non-relieving type	●	●	●	
+						
f Flow direction	Nil	Flow direction: Left to right	●	●	●	
	R	Flow direction: Right to left	●	●	●	
+						
g Pressure unit	Nil	Name plate, caution plate for bowl, and pressure gauge in imperial units: MPa	●	●	●	
	Z	Name plate, caution plate for bowl, and pressure gauge in imperial units: psi, °F	○ Note 8)	○ Note 8)	○ Note 8)	

Note 1) Option B, G, H are not assembled and supplied loose at the time of shipment.

Note 2) Assembly of a bracket and set nuts (AW30 to AW40)
Including 2 mounting screws for the AW60

Note 3) Mounting thread for pressure gauge: 1/8 for the AW30, 1/4 for the AW40 and AW60. Pressure gauge type: G43

Note 4) Only metal bowl 2 is available.

Note 5) The only difference from the standard specifications is the adjusting spring for the regulator. It does not restrict the setting of 0.2 MPa or more. When the pressure gauge is attached, a 0.2 MPa pressure gauge will be fitted.

Note 6) Without a valve function

Note 7) For thread type: NPT. This product is for overseas use only according to the new Measurement Law. (The SI unit type is provided for use in Japan.)

Note 8) ○: For thread type: NPT only

② High Pressure

Strong materials are used in the manufacturing of air filters intended for high pressure operation. Also, construction modification allows a wider regulating pressure range.

Specifications

Made-to-order part no.	-X425
Proof pressure (MPa)	3.0
Maximum operating pressure (MPa)	2.0
Set pressure range (MPa)	0.1 to 1.6
Ambient and fluid temperature (°C)	-5 to 60°C (with no freezing)



AW30-03-2-X425

Applicable Model

Model	AW20	AW30	AW40	AW40-06	AW60
Port size	1/8, 1/4	1/4, 3/8	1/4, 3/8, 1/2	3/4	3/4, 1

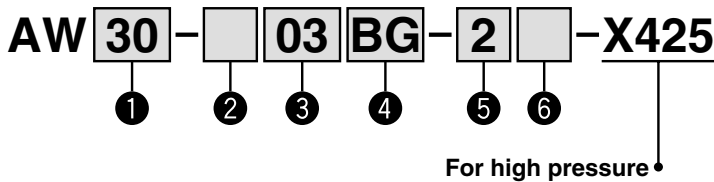

- Option/Semi-standard: Select one each for a to f.
- Option/Semi-standard symbol: When more than one specification is required, indicate in alphanumeric order.
Example) AW30-03BG-2N-X425

	Symbol	Description	① Body size				
			20	30	40	60	
② Thread type	Nil	Rc	●	●	●	●	
	N	NPT	●	●	●	●	
	F	G	●	●	●	●	
+							
③ Port size	01	1/8	●	—	—	—	
	02	1/4	●	●	—	—	
	03	3/8	—	●	●	—	
	04	1/2	—	—	●	—	
	06	3/4	—	—	●	●	
10	1	—	—	—	●		
+							
④ Option	a Mounting	Nil	Without mounting option	●	●	●	●
		B	With bracket	●	●	●	●
		H	With set nut (for panel fitting)	●	●	●	—
+							
b Pressure gauge	Nil	Without pressure gauge	●	●	●	●	
	G	Round type pressure gauge (with limit indicator)	●	●	●	●	
+							
⑤ Bowl	2	Metal bowl	●	●	●	●	
	8	Metal bowl with level gauge	—	●	●	●	
+							
⑥ Semi-standard	c Exhaust mechanism	Nil	Relieving type	●	●	●	●
		N	Non-relieving type	●	●	●	●
	+						
	d Drain port	Nil	With drain cock	●	●	●	●
		J	Drain guide 1/8 Drain guide 1/4	—	●	●	●
+							
e Flow direction	Nil	Flow direction: Left to right	●	●	●	●	
	R	Flow direction: Right to left	●	●	●	●	
+							
f Pressure unit	Nil	Name plate, caution plate for bowl, and pressure gauge in imperial units: MPa	●	●	●	●	
	Z	Name plate, caution plate for bowl, and pressure gauge in imperial units: psi, °F	○	○	○	○	

Note 1) Option B, G, H are not assembled and supplied loose at the time of shipment.

Note 2) Assembly of a bracket and set nuts (AW20 to AW40)

Including 2 mounting screws for the AW60

Note 3) Mounting thread for pressure gauge: 1/8 for the AW20 and AW30, 1/4 for the AW40 and AW60. Pressure gauge type: G46-20-□

Note 4) Only metal bowl 2 and 8 are available.

Note 5) Without a valve function

Note 6) For thread type: NPT. This product is for overseas use only according to the new Measurement Law. (The SI unit type is provided for use in Japan.)

Note 7) ○: For thread type: NPT only

AC

AF□

AR

AL

AW□

A□G

AV

AF800
AF900

Filter Regulator *Series AW10 to AW60*

Filter Regulator with Backflow Function *Series AW20K to AW60K*

			0.4 MPa Setting					Long Bowl						
			①					①						
			Body size					Body size						
			10	20	30	40	60	10	20	30	40	60		
6	d	Set pressure	Nil <small>Note 7)</small>	0.05 to 0.85 MPa setting										
			1 <small>Note 8)</small>	0.02 to 0.2 MPa setting										
	+													
	e	Bowl <small>Note 9)</small>		Nil	Polycarbonate bowl									
				2	Metal bowl									
				6	Nylon bowl									
				8	Metal bowl with level gauge									
				C	With bowl guard									
	+													
	f	Drain port <small>Note 10)</small>		Nil	With drain cock									
				J <small>Note 11)</small>	Drain guide 1/8									
				W <small>Note 12)</small>	Drain cock with barb fitting: For ø6 x ø4 nylon tube									
	+													
	g	Exhaust mechanism		Nil	Relieving type									
				N	Non-relieving type									
+														
h	Flow direction		Nil	Flow direction: Left to right										
			R	Flow direction: Right to left										
+														
i	Pressure unit		Nil	Name plate, caution plate for bowl, and pressure gauge in imperial units: MPa										
			Z <small>Note 13)</small>	Name plate, caution plate for bowl, and pressure gauge in imperial units: psi, °F										
+														
				ZA <small>Note 14)</small>	Digital pressure switch: With unit conversion function									

Note 7) Only the AW10 has a pressure setting of 0.05 to 0.7 MPa.

Note 8) The only difference from the standard specifications is the adjusting spring for the regulator. It does not restrict the setting of 0.2 MPa or more. When the pressure gauge is attached, a 0.2 MPa pressure gauge will be fitted.

Note 9) Refer to Chemical Data on page 287 when selecting a case material.

Note 10) Float type auto drain: The combination of C and D is not possible.

Note 11) Without a valve function

Note 12) Metal bowl: The combination of 2 and 8 is not possible.

Note 13) For thread type: M5 and NPT. This product is for overseas use only according to the new Measurement Law. (The SI unit type is provided for use in Japan.)

The digital pressure switch will be equipped with the unit conversion function, setting to psi initially.

Note 14) For options: E1, E2, E3, E4. This product is for overseas use only according to the new Measurement Law. (The SI unit is provided for use in Japan.)

Note 15) ○: For thread type: M5 and NPT only

Note 16) △: Select with options: E1, E2, E3, E4.

AC

AF□

AR

AL

AW□

A□G

AV

AF800
AF900

Mist Separator Regulator

AWM20 to AWM40

Micro Mist Separator Regulator

AWD20 to AWD40

JIS Symbol
Mist Separator
Regulator

Micro Mist Separator
Regulator

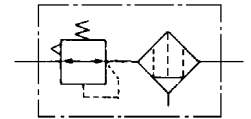
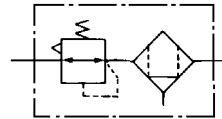

- The AWM series is made up of a regulator and a mist separator to provide optimum results in applications such as clean air blow operations. (Nominal filtration rating: 0.3 μm)
- The AWD series is made up of a regulator and a micro mist separator to provide optimum results in applications such as ultraclean air blow operations. (Nominal filtration rating: 0.01 μm)

How to Order

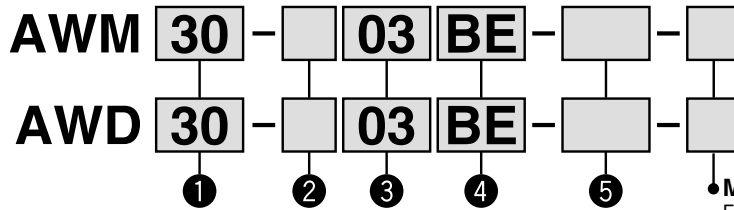

- Option/Semi-standard: Select one each for a to i.
- Option/Semi-standard symbol: When more than one specification is required, indicate in alphanumeric order.
Example) AWM30-03BE-1N

• Made to Order

For details, refer to pages 386 and 387.

	Symbol	Description	① Body size			
			20	30	40	
② Thread type	Nil	Rc	●	●	●	
	N ^{Note 1)}	NPT	●	●	●	
	F ^{Note 2)}	G	●	●	●	
+						
③ Port size	01	1/8	●	—	—	
	02	1/4	●	●	●	
	03	3/8	—	●	●	
	04	1/2	—	—	●	
+						
④ Option	a Mounting	Nil	Without mounting option	●	●	●
		B ^{Note 4)}	With bracket	●	●	●
		H	With set nut	●	●	●
	+					
	b Float type auto drain	Nil	Without auto drain	●	●	●
		C	Float type auto drain (N.C.)	●	●	●
		D	Float type auto drain (N.O.)	—	●	●
	+					
	c Pressure gauge	Nil	Without pressure gauge	●	●	●
		E	Square embedded type pressure gauge	●	●	●
		G	Round type pressure gauge	●	●	●
		M	Round type pressure gauge (with color zone)	●	●	●
Digital pressure switch		1 ^{Note 5)}	Output: NPN output / Electrical entry: Wiring bottom entry	●	●	●
		E2 ^{Note 5)}	Output: NPN output / Electrical entry: Wiring top entry	●	●	●
		E3 ^{Note 5)}	Output: PNP output / Electrical entry: Wiring bottom entry	●	●	●
	E4 ^{Note 5)}	Output: PNP output / Electrical entry: Wiring top entry	●	●	●	
+						
d Set pressure ^{Note 6)}	Nil	0.05 to 0.85 MPa setting	●	●	●	
	1 ^{Note 7)}	0.05 to 0.2 MPa setting	●	●	●	
+						
e Bowl ^{Note 8)}	Nil	Polycarbonate bowl	●	●	●	
	2	Metal bowl	●	●	●	
	6	Nylon bowl	●	●	●	
	8	Metal bowl with level gauge	—	●	●	
	C	With bowl guard	●	—	—	
	6C	Nylon bowl with bowl guard	●	—	—	
+						
f Drain port ^{Note 9)}	Nil	With drain cock	●	●	●	
	J ^{Note 10)}	Drain guide 1/8	●	—	—	
		Drain guide 1/4	—	●	●	
	W ^{Note 11)}	Drain cock with barb fitting: For ø6 x ø4 nylon tube	—	●	●	

Mist Separator Regulator *Series AWM20 to AWM40*

Micro Mist Separator Regulator *Series AWD20 to AWD40*



AWM20, AWD20 AWM40, AWD40

	Symbol	Description	①			
			Body size			
			20	30	40	
5 Semi-standard	g	Exhaust mechanism	Nil	Relieving type		
		N	Non-relieving type			
			+	●	●	●
	h	Flow direction	Nil	Flow direction: Left to right		
		R	Flow direction: Right to left			
			+	●	●	●
	i	Pressure unit	Nil	Name plate, caution plate for bowl, and pressure gauge in imperial units: MPa		
			Z ^{Note 12)}	Name plate, caution plate for bowl, and pressure gauge in imperial units: psi, °F		
			ZA ^{Note 13)}	Digital pressure switch: With unit conversion function		
				●	●	●
			○ ^{Note 14)}	○ ^{Note 14)}	○ ^{Note 14)}	
			△ ^{Note 15)}	△ ^{Note 15)}	△ ^{Note 15)}	

Note 1) Drain guide is NPT1/8 (applicable to the AWM20, AWD20) and NPT1/4 (applicable to the AWM30 to AWM40, AWD30 to AWD40). The auto drain port comes with ø3/8" one-touch fitting (applicable to the AWM30 to AWM40, AWD30 to AWD40).

Note 2) Drain guide is G1/8 (applicable to the AWM20, AWD20) and G1/4 (applicable to the AWM30 to AWM40, AWD30 to AWD40).

Note 3) Option B, G, H, M are not assembled and supplied loose at the time of shipment.

Note 4) Assembly of a bracket and set nuts

Note 5) When choosing with H (panel mount), the installation space for lead wires will not be secured. In this case, select "wiring bottom entry" for the electrical entry.

Note 6) Float type auto drain: when used in combination with C or D, minimum set pressure is: N.O. type-0.1 MPa; N.C. type-0.1 MPa (AD27) and 0.15 MPa (AD37/47).

Note 7) The only difference from the standard specifications is the adjusting spring for the regulator. It does not restrict the setting of 0.2 MPa or more. When the pressure gauge is attached, a 0.2 MPa pressure gauge will be fitted.

Note 8) Refer to Chemical Data on page 287 when selecting a case material.

Note 9) Float type auto drain: The combination of C and D is not possible.

Note 10) Without a valve function

Note 11) Metal bowl: The combination of 2 and 8 is not possible.

Note 12) For thread type: NPT. This product is for overseas use only according to the new Measurement Law. (The SI unit type is provided for use in Japan.) The digital pressure switch will be equipped with the unit conversion function, setting to psi initially. The combination of the round type pressure gauge with color zone "M" and a psi display "Z" is not orderable as a standard product. However, this combination is available as a special.

Note 13) For options: E1, E2, E3, E4. This product is for overseas use only according to the new Measurement Law. (The SI unit is provided for use in Japan.)

Note 14) ○: For thread type: NPT only

Note 15) △: Select with options: E1, E2, E3, E4.

Standard Specifications

Model	AWM20 AWD20	AWM30 AWD30	AWM40 AWD40
Port size	1/8, 1/4	1/4, 3/8	1/4, 3/8, 1/2
Fluid	Air		
Proof pressure	1.5 MPa		
Maximum operating pressure	1.0 MPa		
Set pressure range	0.05 to 0.85 MPa		
Pressure gauge port size ^{Note 1)}	1/8		1/4
Ambient and fluid temperature ^{Note 2)}	-5 to 60°C (with no freezing)		
Nominal filtration rating	AWM20 to AWM40		0.3 μm (99.9% filtered particle size)
	AWD20 to AWD40		0.01 μm (99.9% filtered particle size)
Outlet side oil mist concentration	AWM20 to AWM40		Max. 1.0 mg/m ³ (ANR) (≈ 0.8 ppm) ^{Note 3) Note 4)}
	AWD20 to AWD40		Max. 0.1 mg/m ³ (ANR) (Before saturated with oil 0.01 mg/m ³ (ANR) or less ≈ 0.008 ppm) ^{Note 3) Note 4)}
Rated flow (l/min (ANR)) ^{Note 5)}	AWM20 to AWM40	150	330
	AWD20 to AWD40	90	180
Drain capacity (cm³)	8	25	45
Bowl material	Polycarbonate		
Bowl guard	Semi-standard	Standard	
Construction	Relieving type		
Mass (kg)	0.29	0.59	1.25

Note 1) Pressure gauge connection threads are not available for F.R.L. unit with a square embedded type pressure gauge.

Note 2) -5 to 50°C for the products with the digital pressure switch.

Note 3) When the compressor oil mist discharge concentration is 30 mg/m³ (ANR).

Note 4) Bowl O-ring and other O-rings are slightly lubricated.

Note 5) Conditions: Mist separator inlet pressure: 0.7 MPa; outlet pressure: 0.5 MPa. The rated flow varies depending on the inlet pressure. Keep the air flow within the rated flow to prevent an outflow of lubricant to the outlet side.

- AC
- AF□
- AR
- AL
- AW□
- A□G
- AV
- AF800
- AF900

Series AWM20 to AWM40

Series AWD20 to AWD40

Options/Part No.

Optional specifications		Model		
		AWM20 AWD20	AWM30 AWD30	AWM40 AWD40
Bracket assembly ^{Note 1)}		AW20P-270AS	AR30P-270AS	AR40P-270AS
Set nut		AR20P-260S	AR30P-260S	AR40P-260S
Pressure gauge	Round type ^{Note 2)}	Standard	G36-10-□01	
		0.02 to 0.2 MPa setting	G36-2-□01	
	Round type ^{Note 2)} (with color zone)	Standard	G36-10-□01-L	
		0.02 to 0.2 MPa setting	G36-2-□01-L	
	Square embedded type ^{Note 3)}	Standard	GC3-10AS [GC3P-010AS (Pressure gauge cover only)]	
		0.02 to 0.2 MPa setting	GC3-2AS [GC3P-010AS (Pressure gauge cover only)]	
Digital pressure switch ^{Note 4)}		NPN output / Wiring bottom entry	ISE35-N-25-MLA [ISE35-N-25-M (Switch body only)]	
		NPN output / Wiring top entry	ISE35-R-25-MLA [ISE35-R-25-M (Switch body only)]	
		PNP output / Wiring bottom entry	ISE35-N-65-MLA [ISE35-N-65-M (Switch body only)]	
		PNP output / Wiring top entry	ISE35-R-65-MLA [ISE35-R-65-M (Switch body only)]	
Float type auto drain ^{Note 5) Note 6)}		N.C.	AD27	AD37
		N.O.	—	AD38
				AD47
				AD48

Semi-standard/Bowl Assembly Part No.

Semi-standard specifications					Model			
Bowl material	^{Note 5) Note 6)} Float type auto drain		^{Note 6)} With drain guide	With barb fitting	With bowl guard	AWM20 AWD20	AWM30 AWD30	AWM40 AWD40
	N.C.	N.O.						
Polycarbonate	—	—	—	—	●	C2SF-C	—	—
	●	—	—	—	●	AD27-C	—	—
	—	—	●	—	—	C2SF-J	C3SF-J	C4SF-J
	—	—	—	●	—	—	C3SF-W	C4SF-W
	—	—	●	—	●	C2SF-CJ	—	—
Nylon	—	—	—	—	—	C2SF-6	C3SF-6	C4SF-6
	—	—	—	—	●	C2SF-6C	—	—
	●	—	—	—	—	AD27-6	AD37-6	AD47-6
	—	●	—	—	—	—	AD38-6	AD48-6
	●	—	—	—	●	AD27-6C	—	—
	—	—	●	—	—	C2SF-6J	C3SF-6J	C4SF-6J
	—	—	—	●	—	—	C3SF-6W	C4SF-6W
Metal	—	—	—	—	—	C2SF-6CJ	—	—
	—	—	—	—	—	C2SF-2	C3SF-2	C4SF-2
	●	—	—	—	—	AD27-2	AD37-2	AD47-2
	—	●	—	—	—	—	AD38-2	AD48-2
Metal bowl with level gauge	—	—	●	—	—	C2SF-2J	C3SF-2J	C4SF-2J
	—	—	—	—	—	—	C3LF-8	C4LF-8
	●	—	—	—	—	—	AD37-8	AD47-8
	—	●	—	—	—	—	AD38-8	AD48-8
	—	—	●	—	—	—	C3LF-8J	C4LF-8J

Note 1) Assembly of a bracket and set nuts

Note 2) □ in part numbers for a round pressure gauge indicates a type of connection thread. No indication is necessary for R; however, indicate N for NPT. Please contact SMC regarding the connection thread NPT and pressure gauge supply for psi unit specifications.

Note 3) Including one O-ring and 2 mounting screws. [] : Pressure gauge cover only

Note 4) Lead wire with connector (2 m), adapter, lock pin, O-ring (1 pc.), mounting screw (2 pcs.) are attached. [] : Switch body only.

Also, regarding how to order the digital pressure switch, please refer to page 388.

A separate pressure switch adapter assembly (AW60P-310AS) is required only for AW60(K). For mounting, please use the included mounting screws (M3 x 0.5 x 14).

The mounting screw (M3 x 0.5 x 7) attached to the digital pressure switch assembly will not be required.

Note 5) Minimum operating pressure: N.O. type—0.1 MPa; N.C. type—0.1 MPa (AD27) and 0.15 MPa (AD37/47). Please contact SMC for psi and °F unit specifications.

Note 6) Please consult SMC for details on drain piping to fit NPT or G port sizes.

Note) • Including O-ring.

• Bowl assembly for the AWM30/40, AWD30/40 comes with a bowl guard (steel band material). (except when the bowl material is metal)



Series AWM20 to AWM40 Series AWD20 to AWD40 Specific Product Precautions

Be sure to read before handling. Refer to front matters 42 and 43 for Safety Instructions and pages 287 to 291 for F.R.L. Precautions.

Selection

⚠ Warning

1. Residual pressure release (outlet pressure release) is not complete by releasing inlet pressure. Please contact SMC regarding residual pressure release.

Air Supply

⚠ Caution

1. Install an air filter (AF series) as a pre-filter on the inlet side of the mist separator regulator to prevent premature clogging.
2. Install a mist separator (AFM series) as a pre-filter on the inlet side of the micro mist separator regulator to prevent premature clogging.

Maintenance

⚠ Warning

1. Replace the element every 2 years or when the pressure drop becomes 0.1 MPa, whichever comes first, to prevent damage to the element.

Mounting and Adjustment

⚠ Caution

1. Set the regulator while verifying the displayed values of the inlet and outlet pressure gauges. Turning the regulator knob excessively can cause damage to the internal parts.
2. The pressure gauge included with regulators for 0.02 to 0.2 MPa setting is for up to 0.2 MPa use only. Exceeding 0.2 MPa of pressure can damage the gauge.
3. Do not use tools on the pressure regulator knob as this may cause damage. It must be operated manually.

Mounting and Adjustment

⚠ Warning

1. Be sure to unlock the knob before adjusting the pressure and lock it after setting the pressure. Failure to follow this procedure can cause damage to the knob and the outlet pressure may fluctuate.
 - Pull the pressure regulator knob to unlock. (You can visually verify this with the "orange mark" that appears in the gap.)
 - Push the pressure regulator knob to lock. When the knob is not easily locked, turn it left and right a little and then push it (when the knob is locked, the "orange mark", i.e., the gap will disappear).



2. A knob cover is available to prevent careless operation of the knob. Refer to page 389 for details.

AC

AF□

AR

AL

AW□

A□G

AV

AF800
AF900

Series AWM20 to AWM40

Series AWD20 to AWD40

Flow Characteristics (Representative values)

Condition: Inlet pressure 0.7 MPa

AWM20 Rc 1/4

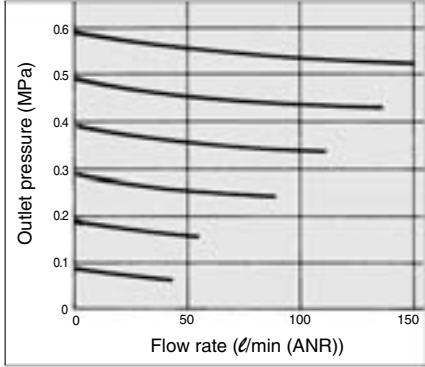

AWM30 Rc 3/8

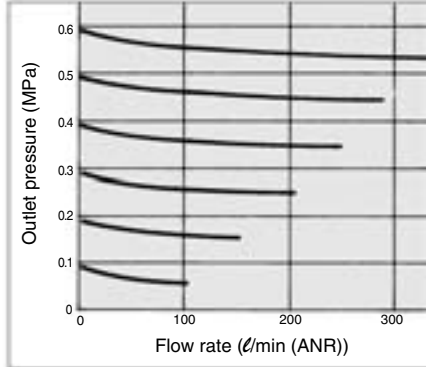

AWM40 Rc 1/2

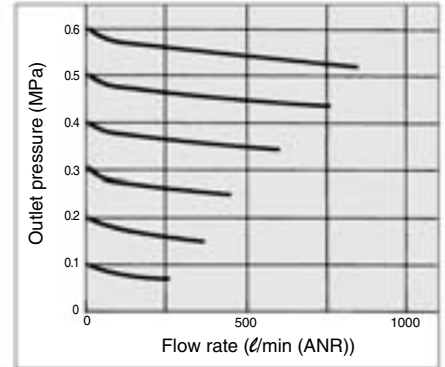

AWD20 Rc 1/4

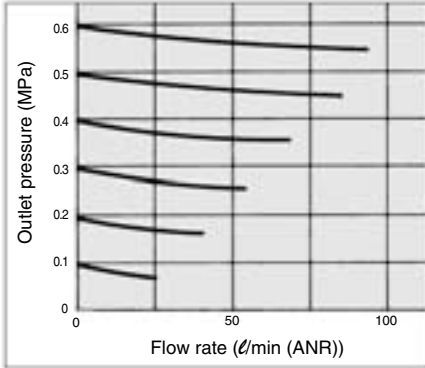

AWD30 Rc 3/8

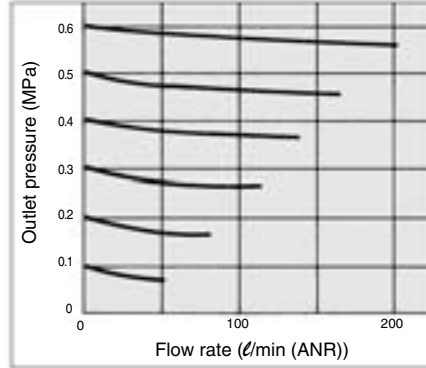

AWD40 Rc 1/2

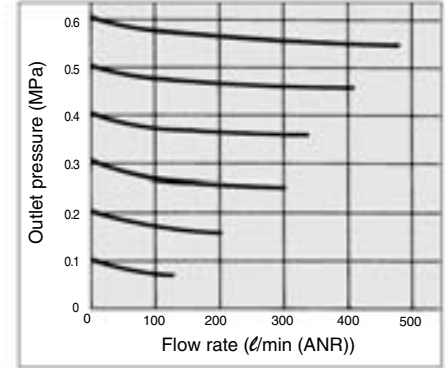

Pressure Characteristics (Representative values)

Conditions: Inlet pressure 0.7 MPa, Outlet pressure 0.2 MPa, Flow rate 20 ℓ/min (ANR)

AWM20

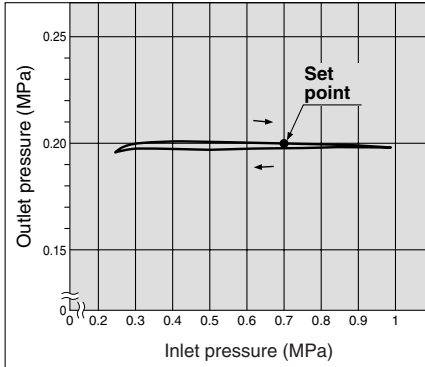

AWM30

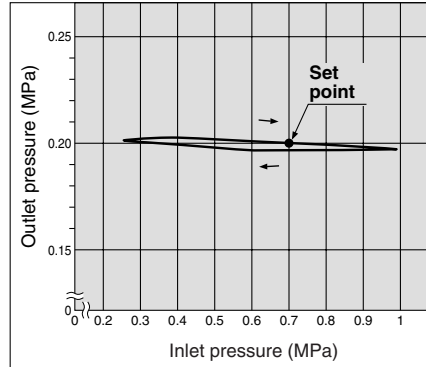

AWM40

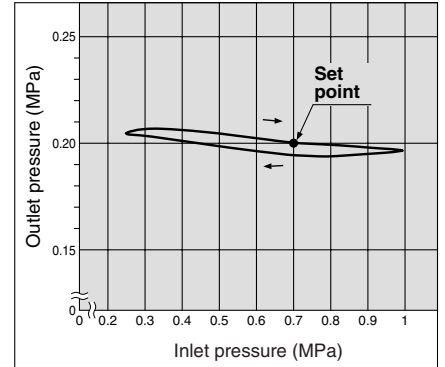

AWD20

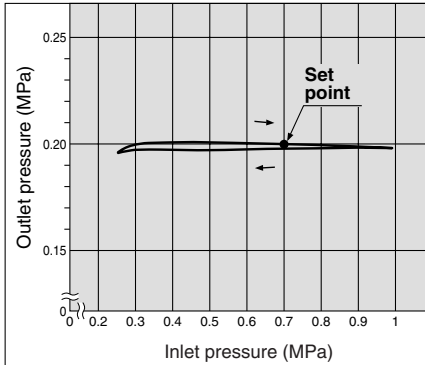

AWD30

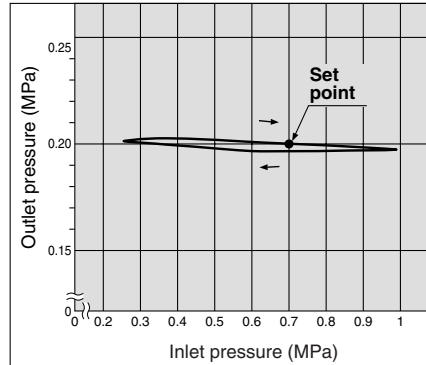

AWD40

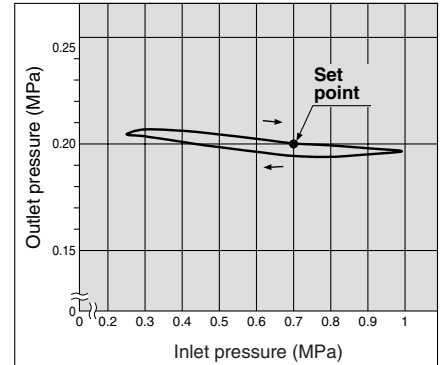

Mist Separator Regulator *Series AWM20 to AWM40*

Micro Mist Separator Regulator *Series AWD20 to AWD40*

Construction

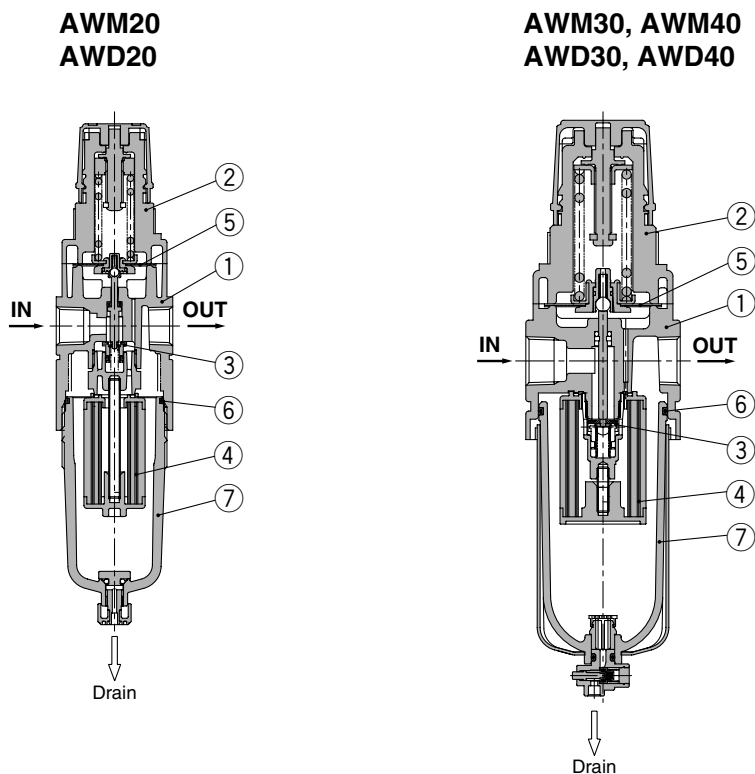

Component Parts

No.	Description	Material	Model	Color
1	Body	Aluminum die-cast	AWM20 to AWM40 AWD20 to AWD40	Platinum silver
2	Bonnet	Polyacetal	AWM20 to AWM40 AWD20 to AWD40	Black

Replacement Parts

No.	Description	Material	Part no.		
			AWM20 AWD20	AWM30 AWD30	AWM40 AWD40
3	Valve assembly	Brass, HNBR	AWM20P-090AS	AWM30P-090AS	AWM40P-090AS
4	Element assembly	AWM20 to AWM40	AFM20P-060AS	AFM30P-060AS	AFM40P-060AS
		AWD20 to AWD40	AFD20P-060AS	AFD30P-060AS	AFD40P-060AS
5	Diaphragm assembly	Weatherable NBR	AR20P-150AS	AR30P-150AS	AR40P-150AS
6	Bowl O-ring	NBR	C2SFP-260S	C3SFP-260S	C4SFP-260S
7	Bowl assembly ^{Note 1)}	Polycarbonate	C2SF	C3SF ^{Note 2)}	C4SF ^{Note 2)}

Note 1) Bowl O-ring is included. Please contact SMC regarding the bowl assembly supply for psi and °F unit specifications.

Note 2) Bowl assembly for the AWM30/40, AWD30/40 comes with a bowl guard (steel band material).

AC

AF□

AR

AL

AW□

A□G

AV

AF800
AF900

Series AWM20 to AWM40

Series AWD20 to AWD40

Dimensions

AWM20
AWD20

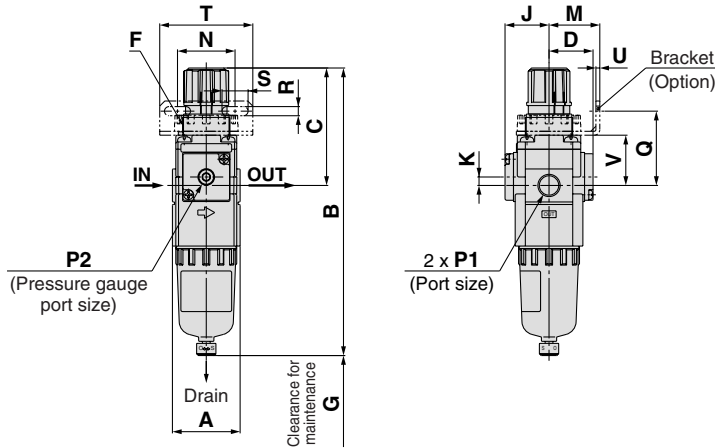

Panel fitting dimension

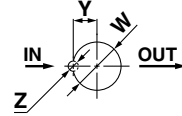
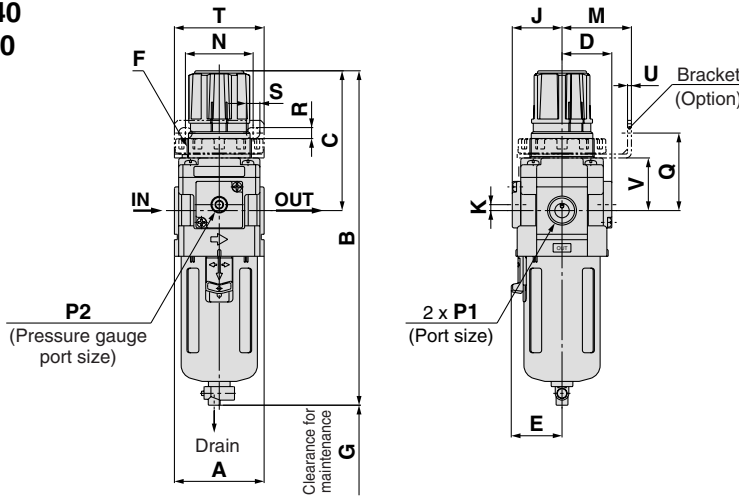

Plate thickness
AWM20, AWD20: Max. 3.5

AWM30, AWM40
AWD30, AWD40



Panel fitting dimension

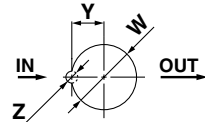
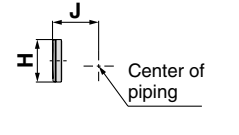
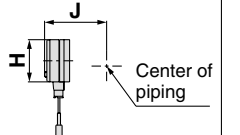
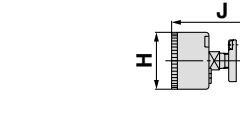
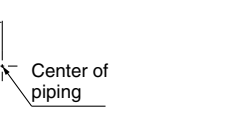
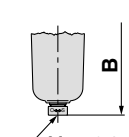
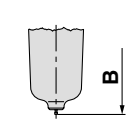
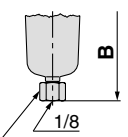
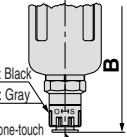
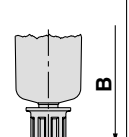
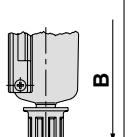
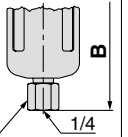
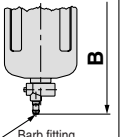

Plate thickness
AWM30, AWD30: Max. 3.5
AWM40, AWD40: Max. 5

Applicable model	AWM20 to AWM40, AWD20 to AWD40			
Option	Square embedded type pressure gauge	Digital pressure switch	Round type pressure gauge	Round type pressure gauge (with color zone)
Dimensions				

Applicable model	AWM20, AWD20				AWM30/40, AWD30/40			
	Optional/Semi-standard specifications	With auto drain (N.C.)	Metal bowl	With drain guide	With auto drain (N.O./N.C.)	Metal bowl	Metal bowl with level gauge	With drain guide
Dimensions								

Model	Standard specifications											Optional specifications							
	P1	P2	A	B (Note)	C	D	E	F	G	J	K	Square type pressure gauge	Digital pressure switch	Round type pressure gauge	Round type pressure gauge (with color zone)				
AWM20/AWD20	1/8, 1/4	1/8	40	173	73	26	—	M28 x 1	40	26	5	□28	27	□27.8	37.5	ø37.5	63	ø37.5	63
AWM30/AWD30	1/4, 3/8	1/8	53	201	86	29.5	30	M38 x 1.5	55	29.5	3.5	□28	30.5	□27.8	41	ø37.5	66	ø37.5	66
AWM40/AWD40	1/4, 3/8, 1/2	1/4	70	239	92	37.5	38	M42 x 1.5	80	37.5	1.5	□28	38.5	□27.8	49	ø42.5	76	ø42.5	76

Model	Optional specifications											Semi-standard specifications				
	Bracket mount					Panel mount						With auto drain	With barb fitting	With drain guide	Metal bowl	Metal bowl with level gauge
	M	N	Q	R	S	T	U	V	W	Y	Z	B (Note)	B (Note)	B (Note)	B (Note)	B (Note)
AWM20/AWD20	30	34	44	5.4	15.4	55	2.3	30	28.5	14	6	190	—	164	160	—
AWM30/AWD30	41	40	46	6.5	8	53	2.3	31	38.5	19	7	242	209	208	214	234
AWM40/AWD40	50	54	54	8.5	10.5	70	2.3	35.5	42.5	21	7	278	247	246	252	272

Note) The total length of B dimension is the length when the filter regulator knob is unlocked.

AC

AF□

AR

AL

AW□

A□G

AV

**AF800
AF900**

Mist Separator Regulator *AWM20 to AWM40* Micro Mist Separator Regulator *AWD20 to AWD40* Made to Order Specifications:



Please contact SMC for detailed dimensions, specifications, and lead times.

① 0.4 MPa Setting

The maximum set pressure is 0.4 MPa. When a pressure gauge is included, the display will show a range from 0 to 0.4 MPa.

Specifications

Proof pressure	1.5 MPa
Maximum operating pressure	1.0 MPa
Set pressure range	0.05 to 0.4 MPa

Applicable Model

Model	AWM20	AWM30	AWM40
	AWD20	AWD30	AWD40
Port size	1/8, 1/4	1/4, 3/8	1/4, 3/8, 1/2

② Long Bowl

Drain capacity is greater than that of standard models.

Applicable Model/Drain Capacity

Model	AWM20	AWM30	AWM40
	AWD20	AWD30	AWD40
Port size	1/8, 1/4	1/4, 3/8	1/4, 3/8, 1/2
Drain capacity (cm ³)	19	43	88

Note) Please consult SMC for dimensions.

How to Order

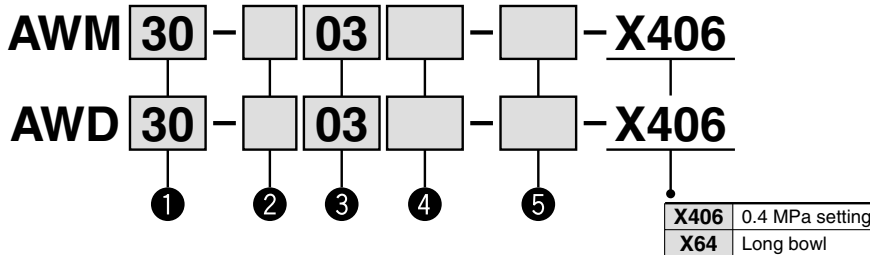

- Option/Semi-standard: Select one each for a to i.
- Option/Semi-standard symbol: When more than one specification is required, indicate in alphanumeric order.
Example) AWM30-03BE-2N-X406

	Symbol	Description	① Body size			① Body size			
			20	30	40	20	30	40	
② Thread type	Nil	Rc	●	●	●	●	●	●	
	N Note 1)	NPT	●	●	●	●	●	●	
	F Note 2)	G	●	●	●	●	●	●	
③ Port size	+								
	01	1/8	●	—	—	●	—	—	
	02	1/4	●	●	●	●	●	●	
	03	3/8	—	●	●	—	●	●	
	04	1/2	—	—	●	—	—	●	
④ Option	a Mounting	Nil	Without mounting option	●	●	●	●	●	●
		B Note 4)	With bracket	●	●	●	●	●	●
		H	With set nut (for panel fitting)	●	●	●	●	●	●
	b Float type auto drain	+							
		Nil	Without auto drain	●	●	●	—	—	—
		C	Float type auto drain (N.C.)	●	●	●	—	—	—
		D	Float type auto drain (N.O.)	—	●	●	—	—	—
	c Pressure gauge	+							
		Nil	Without pressure gauge	●	●	●	●	●	●
		E	Square embedded type pressure gauge (with limit indicator)	●	●	●	●	●	●
		G	Round type pressure gauge	●	●	●	●	●	●
		M	Round type pressure gauge (with color zone)	●	●	●	●	●	●
Digital pressure switch		E1 Note 5)	Output: NPN output / Electrical entry: Wiring bottom entry	●	●	●	●	●	●
		E2 Note 5)	Output: NPN output / Electrical entry: Wiring top entry	●	●	●	●	●	●
	E3 Note 5)	Output: PNP output / Electrical entry: Wiring bottom entry	●	●	●	●	●	●	
	E4 Note 5)	Output: PNP output / Electrical entry: Wiring top entry	●	●	●	●	●	●	

Note 1) Drain guide is NPT 1/8 (applicable to the AWM20, AWD20) and NPT 1/4 (applicable to the AWM30 to AWM40, AWD30 to AWD40). The auto drain port comes with ø3/8" One-touch fitting (applicable to the AWM30 to AWM40, AWD30 to AWD40).

Note 2) Drain guide is G 1/8 (applicable to the AWM20, AWD20) and G 1/4 (applicable to the AWM30 to AWM40, AWD30 to AWD40).

Note 3) Option B, G, H, M are not assembled and supplied loose at the time of shipment.

Note 4) Assembly of a bracket and set nuts

Note 5) When choosing with H (panel mount), the installation space for lead wires will not be secured. In this case, select "wiring bottom entry" for the electrical entry.

Mist Separator Regulator *Series AWM20 to AWM40*

Micro Mist Separator Regulator *Series AWD20 to AWD40*

0.4 MPa Setting	Long Bowl		
-----------------	-----------	--	--

	Symbol	Description	①			①					
			Body size			Body size					
			20	30	40	20	30	40			
5 Semi-standard	d	Note 6) Nil	0.05 to 0.85 MPa setting		-	-	-	●	●	●	
		1 Note 7)	0.05 to 0.2 MPa setting		-	-	-	●	●	●	
	+										
	e	Bowl ^{Note 8)}	Nil	Polycarbonate bowl		●	●	●	●	●	●
			2	Metal bowl		●	●	●	●	●	●
			6	Nylon bowl		●	●	●	●	●	●
			8	Metal bowl with level gauge		-	●	●	-	-	-
			C	With bowl guard		●	-	-	●	-	-
			6C	Nylon bowl with bowl guard		●	-	-	●	-	-
	+										
	f	Drain port ^{Note 9)}	Nil	With drain cock		●	●	●	●	●	●
			J Note 10)	Drain guide 1/8		●	-	-	●	-	-
			W Note 11)	Drain cock with barb fitting: For ø6 x ø4 nylon tube		-	●	●	-	●	●
			+			-	●	●	-	●	●
	g	Exhaust mechanism	Nil	Relieving type		●	●	●	●	●	●
			N	Non-relieving type		●	●	●	●	●	●
	+										
	h	Flow direction	Nil	Flow direction: Left to right		●	●	●	●	●	●
			R	Flow direction: Right to left		●	●	●	●	●	●
	+										
i	Pressure unit	Nil	Name plate and caution plate for bowl in imperial units: MPa		●	●	●	●	●	●	
		Z Note 12)	Name plate and caution plate for bowl, and pressure gauge in imperial units: psi, °F		○ Note 14)	○ Note 14)	○ Note 14)	○ Note 14)	○ Note 14)	○ Note 14)	
		ZA Note 13)	Digital pressure switch: With unit conversion function		△ Note 15)	△ Note 15)	△ Note 15)	△ Note 15)	△ Note 15)	△ Note 15)	

Note 6) Float type auto drain: when used in combination with C or D, minimum set pressure is: N.O. type-0.1 MPa; N.C. type-0.1 MPa (AD27) and 0.15 MPa (AD37/47).

Note 7) The only difference from the standard specifications is the adjusting spring for the regulator. It does not restrict the setting of 0.2 MPa or more. When the pressure gauge is attached, a 0.2 MPa pressure gauge will be fitted.

Note 8) Refer to Chemical Data on page 287 when selecting a case material.

Note 9) Float type auto drain: The combination of C and D is not possible.

Note 10) Without a valve function

Note 11) Metal bowl: The combination of 2 and 8 is not possible.

Note 12) For thread type: NPT. This product is for overseas use only according to the new Measurement Law. (The SI unit type is provided for use in Japan.) The digital pressure switch will be equipped with the unit conversion function, setting to psi initially.

Note 13) For options: E1, E2, E3, E4. This product is for overseas use only according to the new Measurement Law. (The SI unit is provided for use in Japan.)

Note 14) ○: For thread type: NPT only

Note 15) △: Select with options: E1, E2, E3, E4.

- AC
- AF□
- AR
- AL
- AW□
- A□G
- AV
- AF800
- AF900



Option Digital Pressure Switch



Refer to Best Pneumatics No. 6 for the Specific Product Precautions.

ISE35 - **N** - **25** - **M** **L** **A**

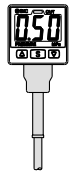
① ② ③ ④ ⑤

	Symbol	Description
① Electrical entry	N	Wiring bottom entry 
	R	Wiring top entry 
② Output	+	
	25	NPN output
	65	PNP output
③ Display unit <small>Note 1)</small>	+	
	Nil <small>Note 1)</small>	With unit conversion function
	M	Fixed SI unit
	P <small>Note 1)</small>	Pressure unit: psi (initial value) with unit conversion function
④ Lead wire	+	
	Nil	Without lead wire
	L	Lead wire (2 m) with connector
⑤ Accessories	+	
	Nil	Without accessories (switch body only)
	A	With accessories (adapter, O-ring (1 pc.), mounting screw (2 pcs.), lock pin)

Note 1) This product is for overseas use only according to the new Measurement Law. (The SI unit type is provided for use in Japan.) Name plate is included.

Note 2) Instruction manual is attached.

Note 3) When ordering the body only, select the symbol from ① to ③ respectively.

Applicable Series

F.R.L. unit	AC20, AC25, AC30, AC40, AC50, AC55, AC60
	AC20A, AC30A, AC40A, AC50A, AC60A
	AC20B, AC25B, AC30B, AC40B, AC50B, AC55B, AC60B
	AC20C, AC25C, AC30C, AC40C
	AC20D, AC30D, AC40D
Regulator	AR20(K), AR25(K), AR30(K), AR40(K), AR50(K), AR60(K)
Filter regulator	AW20(K), AW30(K), AW40(K), AW60(K)
Mist separator regulator	AWM20, AWM30, AWM40
Micro mist separator regulator	AWD20, AWD30, AWD40

Digital Pressure Switch Details

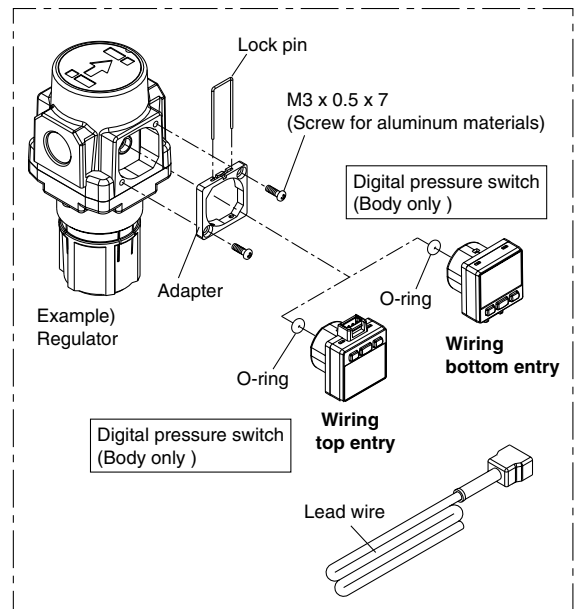

Specifications

Rated pressure range	0 to 1 MPa	
Set pressure range	-0.1 to 1 MPa	
Withstand pressure	1.5 MPa	
Set pressure resolution	0.01 MPa	
Power supply voltage	12 to 24 VDC, Ripple (p-p) 10% or less (with power supply polarity protection)	
Current consumption	55 mA or less (at no load)	
Switch output	NPN or PNP open collector 1 output	
	Max. load current	80 mA
	Max. applied voltage	30 V (with NPN output)
	Residual voltage	1 V or less (with load current of 80 mA)
	Response time	1 s
	Anti-chattering function	(Response time selections: 0.25, 0.5, 2, 3)
	Short circuit protection	With short circuit protection
Repeatability	±1%F.S. or less	
Hysteresis	Hysteresis mode	Variable (can be set from 0)
	Window comparator mode	
Display	3-digit, 7-segment indicator, 2-color display (Red/Green) can be interlocked with the switch output.	
Display accuracy	±2%F.S. ±1 digit (at 25°C ± 3°C)	
Indication light	Illuminates when output is turned ON. (Green)	
Environmental resistance	Enclosure	IP40
Lead wire with connector	ø3.4 3-wire 25AWG 2 m	

Output

NPN open collector

Max. 30 V, 80 mA
Residual output voltage 1 V or less

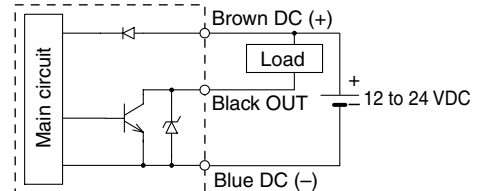

PNP open collector

Max. 80 mA
Residual output voltage 1 V or less

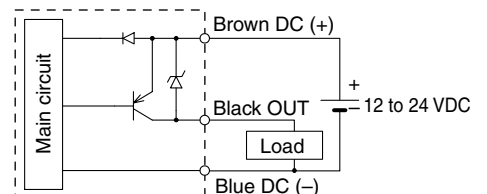

Option Knob Cover

Prevents careless knob operation.

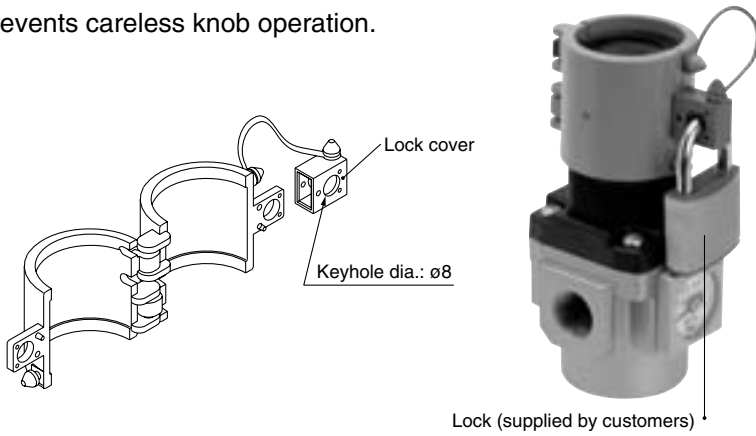

Part no.	Applicable model
AR20P-580AS	AC20□, AR20(K), AW20(K), AWM20, AWD20
AR25P-580AS	AC25□, AR25(K)
AR30P-580AS	AC30□, AR30(K), AW3(K), AWM30, AWD30
AR40P-580AS	AC40□(-06), AR40(K)(-06), AW40(K)(-06), AWM40, AWD40

AC

AF□

AR

AL

AW□

A□G

AV

AF800
AF900