

Please carefully read and save these instructions before attempting to assemble, maintain, install, or operate this product. Observe all safety information to protect yourself and others. Failure to observe the instructions may result in property damage and/or personal injury. Please keep instructions for future reference.

## Important Operating Instructions



# 2 GALLON TWIN STACK AIR COMPRESSOR

Model: 8424,8465,  
8682,51735

### CALIFORNIA PROPOSITION 65

**WARNING:** You can create dust when you cut, sand, drill or grind materials such as wood, paint, metal, concrete, cement, or other masonry. This dust often contains chemicals known to cause cancer, birth defects, or other reproductive harm. Wear protective gear.

**WARNING:** This product or its power cord may contain chemicals, including lead, known to the State of California to cause cancer and birth defects or other reproductive harm. Wash hands after handling.

### CAUTION:

**FOR YOUR OWN SAFETY READ INSTRUCTION MANUAL COMPLETELY AND CAREFULLY BEFORE OPERATING THIS OIL-FREE AIR COMPRESSOR KIT.**

### SPECIFICATIONS

**Type:** Twin Stack, Oil free

**CFM:** 1 CFM @ 40 PSI  
.5 CFM @ 90 PSI

**Horsepower:** 1/3 HP

**Maximum PSI:** 100 PSI

### GENERAL SAFETY WARNING

Please read and understand all instructions. Failure to follow all instructions listed below may result in electric shock, fire and/or serious personal injury.

Failure to comply with all electrical specifications may result in serious injury. All adjustments or repairs must be done with the compressor disconnected from the power source.

### SAFETY INSTRUCTIONS

#### POWER SUPPLY

Your compressor must be connected to a 120V outlet, using a 15-amp time delay fuse or circuit breaker. Failure to connect in this way can result in injury from shock or fire.

### GROUNDING

Your compressor must be properly grounded. Not all outlets are properly grounded. If you have hesitations on whether or not your outlet is properly grounded, have it checked by a qualified electrician.

**WARNING:** If not properly grounded, this compressor can cause electrical shock, particularly when used in damp locations. If the power cord is worn or damaged in any way have it replaced immediately.

If the compressor should breakdown, the grounding provides a path of least resistance for the electric current which reduces the risk of electric shock. The plug must be plugged into an appropriate outlet that is grounded in accordance with the local codes and ordinances.

**WARNING:** To maintain proper grounding, do not alter the grounding prong in any manner.

For warranty purchases, please keep your dated proof of purchase. File or attach to the manual for safekeeping.

## 120V OPERATION

As received from the factory, your compressor is ready to run for 120V operation. This machine is intended for use on a circuit that has an outlet and a plug which looks like the one illustrated in Fig. 1.

**WARNING: Do not use a two-prong adapter.**

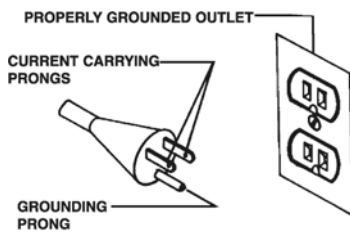

FIGURE 1

## EXTENSION CORDS

The use of any extension cord will cause some loss of power. It is recommended to use a longer air hose instead of an extension cord. Use the chart below to determine the minimum wire size extension cord. Use only 3-wire extension cords which have 3-prong grounding type plugs and 3-hole receptacles which accept the tool's plug.

For circuits that are further away from the electrical circuit box, the wire size must be increased proportionately in order to deliver ample voltage to the motor. Refer to Fig. 2 for wire length and size.

LENGTH OF CONDUCTOR	WIRE SIZES REQUIRED (AMERICAN WIRE GAUGE) 120V LINES
0-25 FEET	NO. 16
26-50 FEET	NO. 16
51-100 FEET	NO. 14

FIGURE 2

## OPERATION CONTROLS

### CHECK VALVE

When the compressor is operating, the check valve is "open", allowing compressed air to enter the air tank. When the air compressor reaches "Cut-Out" pressure, the check valve "closes", allowing air pressure to remain inside the air tank.

### ON/OFF SWITCH (A) FIG. 3

Turn this switch ON (press downwards) to provide power to the automatic pressure switch and OFF to remove power at the end of each use.

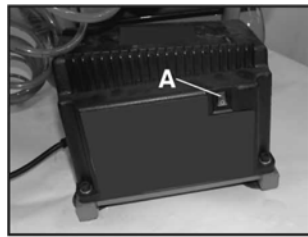

FIGURE 3

### PRESSURE SWITCH

The pressure switch automatically starts the motor when the tank pressure drops below the factory set "Cut-in" pressure. It also stops the motor when the air tank pressure reaches the factory set "Cut-Out" pressure.

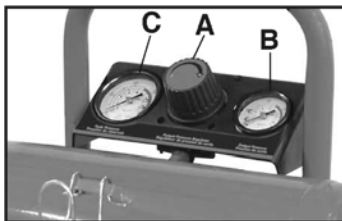

FIGURE 4

### REGULATOR (A) FIG. 4

The air pressure coming from the air tank is controlled by the regulator. Turn the regulator knob clockwise to increase pressure and counterclockwise to decrease pressure. To avoid minor readjustment after making a change in the pressure setting, always approach the desired pressure from a lower pressure. When reducing from a higher to a lower setting, first reduce the pressure less than that desired, then bring it up to the desired pressure. Depending on the air requirements of each particular accessory, the outlet regulated air pressure may have to be adjusted while operating the accessory.

### OUTLET PRESSURE GAUGE (B) FIG. 4

The tank pressure gauge indicates the reserve air pressure in the tank.

### TANK PRESSURE GAUGE (C) FIG. 5

Indicates the available reserve air pressure in the tank.

### DRAIN VALVE (A) FIG. 5

The drain valve is located on the base of the air tank and is used to drain condensation at the end of each use.

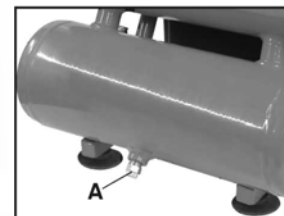

FIGURE 5

## SAFETY PRESSURE RELEASE VALVE (A) FIG. 6

If the pressure switch does not shut off the air compressor at its cutout pressure setting and the air pressure keeps rising, the safety valve will protect against high pressure by “popping out” above factory set pressure (slightly higher than the pressure switch cut-out setting).

**WARNING: If the safety pressure release valve does not work properly, over pressurization may occur, causing air tank to rupture or explode. Pull the ring on the safety valve daily to make sure that the safety valve operates freely. If the valve is stuck or does not operate smoothly, it must be replaced with the same type of valve.**

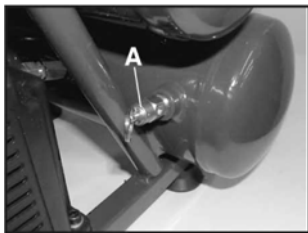

FIGURE 6

## SETTING UP YOUR AIR COMPRESSOR

Operate the air compressor in a dry, clean and well ventilated area. Clean off dust or dirt that collects on the air compressor. A clean air compressor runs cooler and provides longer service. The ventilation openings on your air compressor are necessary to maintain proper operating temperature. Do not place rags or other containers near these openings.

## ADDITIONAL REGULATORS AND CONTROLS

Since the air tank pressure is usually greater than that which is needed, a regulator is employed to control the air pressure ahead of any individual driven device. Separate air transformers which combine the function of air regulation, moisture and dirt removal should be used where applicable.

## PREPARATION FOR USE

- 1) Before attaching the air hose or accessories, make sure the On/Off switch is set to “OFF” and the air regulator is closed (completely turned counterclockwise).
- 2) Attach the 1/4in. female fitting (A Fig.7) to one end of the coil hose (B), then connect the female fitting (A) into the quick connect outlet (C) at the back of the compressor, then attach the 1/4in. female quick connect (D) to the other end of the coil hose. Attach optional air tool or supplied accessories. To prevent air leaks, it is recommended to install Teflon Tape (not supplied) on the threads at both ends of the coil hose.

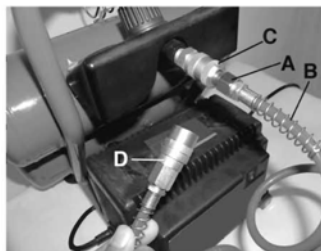

FIGURE 7

- 5) Turn the switch to the On position and allow tank pressure to build. Motor will stop when

tank pressure reaches “cut-out” pressure.

- 6) Open the regulator by turning it clockwise. Adjust the regulator to the correct pressure setting. The compressor is ready.

**WARNING: Too much air pressure causes a hazardous risk of bursting. Check the manufacturer’s maximum pressure rating for air tools and accessories. The regulator outlet pressure must never exceed the maximum pressure rating of the tool being used.**

## AFTER USE

- 1) Set the switch to Off.
- 2) Turn the regulator counterclockwise to set the outlet pressure to zero.
- 3) Disconnect the air tool or accessory.
- 4) Pull ring on safety valve (A) Fig.6, allowing air to bleed from the tank until tank pressure is approximately 20 PSI. Release safety valve ring.
- 5) Drain water from air tank. Turn drain valve (A) Fig. 5 counterclockwise to open.

**WARNING: Water will condense in the air tank. The water will corrode and weaken the air tank causing a risk of air tank rupture if it is not drained properly.**

NOTE: If drain valve is plugged, pull ring on safety valve (A) Fig.6, and hold until all air pressure has been released. The drain valve can

then be removed, cleaned, and reinstalled.

6. After the water has been completely drained, turn the drain valve to close. The air compressor can now be stored.

### **MAINTENANCE**

Before doing any maintenance or adjustments to your air compressor, the following safety precautions should be taken:

- Disconnect electrical power.
- Release air tank pressure.

### **DAILY OR BEFORE EACH USE**

- 1) Drain condensation from tank.
- 2) Check for unusual noise or vibration.
- 3) Be sure all nuts and bolts are tight.

### **KEEP TOOL CLEAN**

Periodically blow out all air passages with dry compressed air. Clean all plastic parts with a soft damp cloth. NEVER use solvents to clean plastic parts. This could possibly dissolve or otherwise damage the material.

**CAUTION: Wear safety glasses while using compressed air.**

### **FAILURE TO START**

Should your compressor fail to start, check to make sure the prongs on the cord plug are making good contact with the outlet. Also, check compressor fuse or tripped circuit breakers in the line.

## **REPLACEMENT PARTS**

For servicing, contact or return to the retailer where you purchased your product along with your proof of purchase. Please use the 10-digit part numbers listed in this manual for all part orders where applicable.

## Troubleshooting Guide

Symptom	Possible Cause(s)	Corrective Action
No start condition	Fuse blown or circuit breaker tripped	Check for cause of blown fuse/breaker and replace
	loose electrical connections	Check wiring connections
	Overheated motor	Turn compressor off, wait until total cool down before restarting
Low pressure	Air leak in safety valve	Check valve manually by pulling upwards on ring. If condition persists, replace valve
	Defective check valve	Replace check valve
Safety valve releasing	Defective pressure switch or improper adjustment	Check for proper adjustment and if problem persists, replace pressure switch
Tank pressure drops when compressor is shut off	Loose drain valve	Tighten drain valve
	Loose connections at regulator or pressure switch	Check connections for leaks, seal with teflon tape
Excessive moisture coming out of air hose	Excessive water in tank	Drain tank through drain valve
	Humidity too high	Move compressor to an area of less humidity.

---

## **Limited Manufacturer Warranty**

*North American Tool (NAT) Industries makes every effort to ensure that this product meets high quality and durability standards. NAT warrants to the original retail consumer a 1-year limited warranty from the date the product was purchased at retail and each product is free from defects in materials. Warranty does not apply to defects due directly or indirectly to misuse, abuse, negligence or accidents, repairs or alterations, or a lack of maintenance. NAT shall in no event be liable for death, injuries to persons or property, or for incidental, special or consequential damages arising from the use of our products. To receive service under warranty, the original manufacturer part must be returned for examination by an authorized service center. Shipping and handling charges may apply. If a defect is found, NAT will either repair or replace the product at its discretion.*



# 2 GALLON TWIN STACK AIR COMPRESSOR

Models: 8424,8465,  
8682,51735

## Parts List

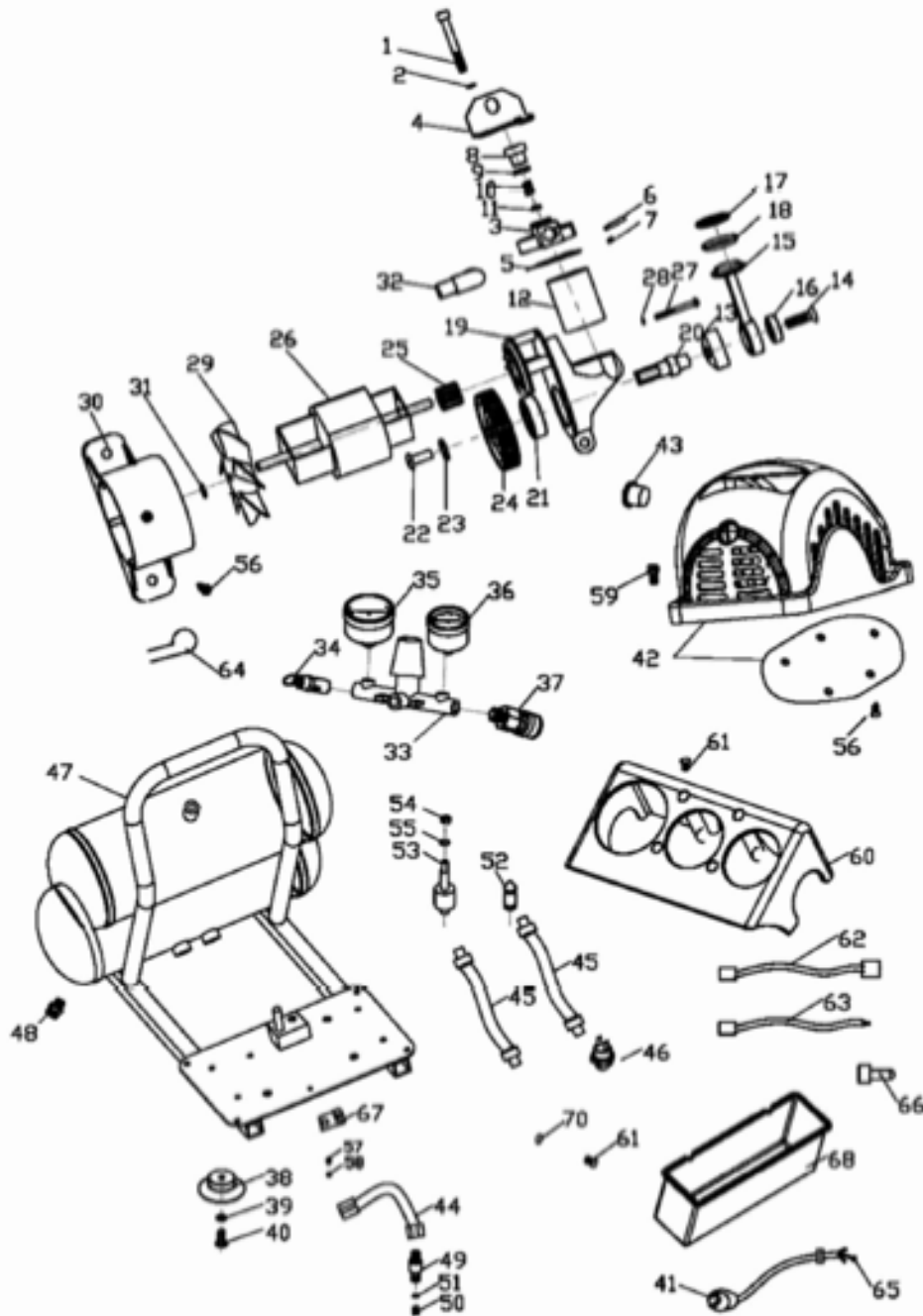

Parts List

**Call 1-800-348-5004 for assistance or replacement parts**

Please provide the following information:

- Model number
- Part description and number as shown in parts list
- Serial number (if any)

Address any correspondence to:

North American Tool Industries  
 84 Commercial Rd  
 Huntington, IN 46750

#	Description	QTY	SKU#	#	Description	QTY	SKU#
1	Bolt M5x55	3		35	Y50 Pressure Gauge	1	43540
2	Spring Washer M5	3		36	Y40 Pressure Gauge	1	40933
3	Cylinder Head	1		37	Quick Coupler	1	38399
4	Support of Cylinder Head	1		38	Cushion	4	
5	Gasket of Cylinder Head	1		39	Washer M5	4	
6	Inlet Valve Reed	1		40	Screw M5x20	4	
7	Cover of Valve Reed	1		41	Power Cord	1	
8	Plug of Exhaust	1		42	Shroud	1	43541
9	O-Ring of Plug	1		43	Electric Switch	1	43542
10	Inlet Spring	1		44	Exhaust Tube	1	
11	Gasket for Exhausting	1		45	Rubber Hose	2	
12	Cylinder	1		46	Pressure Switch	1	
13	Eccentric	1		47	2 Gal Twin Tank	1	
14	Screw M6x15	1		48	Drain Valve	1	
15	Conrod	1		49	Connect of Check Valve	1	
16	Bearing of Conrod	1		50	Spring of Check Valve	1	
17	Cover of Conrod	1		51	Seal Gasket of Check Valve	1	
18	Piston Ring	1		52	Support Rubber	3	
19	Crankcase	1		53	Support Bolt	1	
20	Axle	1		54	Nut M6	1	
21	Bearing of Crankcase	1		55	Spring Washer M6	1	
22	Screw M5x10	1		56	Tapping Screw	6	
23	Washer M5	1		57	Screw M4x6	1	
24	Driven Gear	1		58	Washer M4	1	
25	Active Gear	1		59	Screw M6x25	4	
26	Motor	1		60	Control Panel of Manifold	1	
27	Screw M3x30	2		61	Screw M4x10	6	
28	Spring Washer M3	2		62	Dual End Cord	1	
29	Fan	1		63	Single End Cord	1	
30	Cover of Motor	1		64	R Type Wrap	2	
31	Circlip M6	1		65	Cable Connector	1	
32	Exhaust Elbow	1		66	Cap Press for Cord	2	
33	Regulator Manifold	1	43359	67	Grounding Signal	1	
34	Safety Valve	1	40944	68	Tool Box	1	