

---

**Kaishan  
Rotary Screw  
Air Compressor**

---

**KRSL Series  
Instruction  
Manual**

---

**Direct Drive**

---

PN: 96002018000001

Release: August 2022, Version: B

(USA)

# TABLE OF CONTENTS

---

<b>Safety Information .....</b>	<b>4</b>
1.1 SAFETY ALERT SYMBOLS.....	4
1.2 SAFETY PRECAUTIONS .....	5
1.3 PRESSURE .....	5
1.4 FIRE AND EXPLOSION .....	5
1.5 MOVING PARTS .....	6
1.6 HOT SURFACES.....	6
1.7 PROPER COMPRESSED AIR APPLICATIONS.....	6
1.8 ELECTRICAL SHOCK .....	6
<b>General Information.....</b>	<b>8</b>
2.1 INTRODUCTION .....	8
2.2 THE COMPRESSION CYCLE.....	9
2.3 MOTOR.....	9
2.4 COMPRESSOR LUBRICATION AND COOLING SYSTEM.....	10
2.5 COMPRESSOR DISCHARGE SYSTEM.....	10
2.6 AIREND, INLETVALVE AND FILTRATION SYSTEM.....	12
<b>Fluid Information .....</b>	<b>13</b>
3.1 FLUID GUIDE .....	13
3.2 FLUID CHANGE RECOMMENDATIONS .....	13
<b>Installation .....</b>	<b>14</b>
4.1 COMPRESSOR MOUNTING, SUPPORT AND LOCATION.....	15
4.2 VENTILATION AND COOLING .....	15
4.3 PIPING CONNECTION .....	16
4.4 FLUID LEVEL INSPECTION .....	17
4.5 ELECTRICAL .....	18
4.6 MOTOR ROTATION INSPECTION .....	18
4.7 FAN ROTATION INSPECTION .....	19

<b>Compressor Controller Operation.....</b>	<b>20</b>
5.1 <i>BASIC OPERATION</i> .....	20
5.2 <i>PROGRAM STRUCTURE</i> .....	23
5.3 <i>TECHNICAL DATA</i> .....	32
5.4 <i>THROUBLESHOOTING</i> .....	33
<b>Servicing .....</b>	<b>33</b>
6.1 <i>FLUID CHANGE</i> .....	34
6.2 <i>AIR FILTER</i> .....	34
6.3 <i>FLUID FILTER</i> .....	35
6.4 <i>AIR/OIL SEPARATOR</i> .....	35
6.5 <i>FLUID SAMPLING PROCEDURE</i> .....	35
6.6 <i>MAINTENANCE SCHEDULE</i> .....	36
<b>Troubleshooting Guide.....</b>	<b>36</b>
<b>Standard Terms and Conditions.....</b>	<b>40</b>
<b>Contact Information .....</b>	<b>43</b>

# Safety Information

---

Thank you for choosing the KRSL Series Compressor. Please read this instruction manual carefully before using the compressor. This manual must be kept in the safe place for future reference. Kaishan USA authorized distributors provide maintenance service for KRSL series rotary screw compressors. A certified technician is required to ensure that compressor maintenance is safely handled. By following the instructions in this manual, the user will minimize possibility of an accident throughout the useful life of this equipment.

## 1.1 SAFETY ALERT SYMBOLS

Key hazards are used throughout this manual. The level of hazards seriousness is symbolized as follows:



This symbol identifies immediate hazards which **will** result in severe personal injury, death or substantial property damage.



This symbol identifies hazards or unsafe practices which **could** result in personal injury, death or substantial property damage.



This symbol identifies immediate electrical hazards which **will** result in severe personal injury, death or substantial property damage.



This symbol identifies hazards or unsafe practices which **could** result in personal injury or substantial property damage.



This symbol identifies immediate hot surface hazards which **will** result in severe personal injury.



**NOTICE**

Identifies important installation, operation or maintenance information which is not hazard related.

## ***1.2 SAFETY PRECAUTIONS***

This manual describes the safety precautions, structure and functions of all systems and components, as well as the operation and maintenance methods for the KRSL series rotary screw air compressors. The owner and operator shall read this manual carefully. Only after thorough understanding should the machine be operated for the first time. This manual gives you a general description of the mechanical and electrical systems and maintenance. However, if you have any questions about operating and maintenance of the compressor; please contact your authorized distributor or our service department personnel.

Do not modify the compressor and/or controls in any way except with written factory approval. While not specifically applicable to all types of compressors with all types of main movers, most of the precautionary statements contained herein are applicable to most compressors and the concepts behind these statements are generally applicable to all compressors.



Failure to follow any of these precautions may result in severe personal injury, death, property damage and/or compressor damage

## ***1.3 PRESSURE***

A properly sized pressure relief valve must be installed in the discharge piping ahead (upstream) of any shutoff valve (block valve), heat exchanger, orifice or any potential blockage point. Failure to install a pressure relief valve could result in the rupturing or explosion of some system component. Relieve all pressure internally to the compressor prior to servicing. Do not depend on check valves to hold system pressure. Do not change the pressure setting of the pressure relief valve, restrict the function of the pressure relief valve, or replace the pressure relief valve with a plug. Over pressurization of system or compressor components can occur, resulting in death, severe personal injury or property damage. Do not operate the compressor at pressures in excess of its rating. Never use plastic pipe, rubber hose, or soldered joints in any part of the compressed air system. Failure to ensure system compatibility with compressor piping is dangerous.

## ***1.4 FIRE AND EXPLOSION***

Clean up any spills of lubricant or combustible liquid immediately. Keep sparks and flame away from the compressor. Do not permit smoking during servicing, such as checking or adding fluid. Wipe down spills immediately using industrial cleaner as required. Do not use flammable material for cleaning purposes. Do not operate the compressor in a hazardous environment unless

the compressor has been specially designed for that environment. Wear personal protective equipment including safety goggles and clothing during servicing the compressor. Never use a flammable or toxic solvent for cleaning the air filter or any parts.

### ***1.5 MOVING PARTS***

Keep hands, arms and cloths away from the coupling and fans of the compressor. Do not remove any guards or cabinet panels or attempt to service any compressor part while the compressor is operating.

### ***1.6 HOT SURFACES***

Do not touch any hot surface and parts during the compressor's operation. Keep all body parts away from air/oil receiver tank, steel tubing, airend and after-cooler. Wear personal protective equipment including gloves while servicing the compressor.

### ***1.7 PROPER COMPRESSED AIR APPLICATIONS***

Air from this compressor will cause severe injury or death if used for breathing or food processing. Air used for those processes must meet OSHA and applicable industry regulations. This compressor is designed for use in the compression of normal atmospheric air only. No other gases, vapors or fumes should be exposed to the compressor intake, nor processed through the compressor. Keep personnel away from the compressed air discharge. Use compressed air for cleaning purpose, only with effective chip guarding and personal protective equipment which meet OSHA standard and/or any federal, state, local codes, standard and regulation.

### ***1.8 ELECTRICAL SHOCK***

Never start the compressor unless it is safe to do so. Do not attempt to operate the compressor with a known unsafe condition. Tag the compressor and render it inoperative by disconnecting and locking out all power at the source or otherwise disabling its prime mover so others who may not know of the unsafe condition cannot attempt to operate it until the condition is corrected. Install, use and operate the compressor only in full compliance with all pertinent OSHA regulations and/or any applicable Federal, State, and Local codes, standards and regulations. Never assume it is safe to work on the compressor because it is not operating. Many installations have automatic start/stop controls and the compressor may start at any time.



- Follow all maintenance procedures and check all safety devices on schedule.

- Use the correct compressor fluid at all time

**NOTICE**

- Do not rely on the discharge check valve to isolate the compressed air service line

- Keep panels closed at all times and stay away from hot surfaces to prevent hazards



These instructions, precautions and descriptions cover KRSL series air compressors.

As a service to our customers, we often modify or construct packages to the customer's specifications. This manual may not be appropriate in those cases.

**NOTICE**

Every effort has been taken to ensure complete and correct instructions have been included in this manual. However, possible product updates and changes may have occurred since printing this manual. Kaishan Compressor reserves the right to change specifications without incurring any obligation for equipment previously or subsequently sold.

## General Information

---

### ***2.1 INTRODUCTION***

The KRSL series offer models with power ranging from 30 hp to 200 hp (22 kw to 150 kw) These direct driven compressors have standard full load pressure rating from 100 psi to 175 psi (7 bar to 13 bar). The compressor is a single stage, positive displacement, fluid-flooded rotary screw. A complete package consists of following:

- Compressor (Air End)
- Electric motor
- Starter
- Air Inlet System
- Compressed Air Discharge System
- Lubrication and Cooling System
- Capacity Control System
- Instrumentation Panel
- Air and Fluid Cooling System
- Air/ Fluid separation tank (Reservoir)

All components are assembled on a structural steel base with enclosure. The control panel is located in the front of the enclosure door panel. Acoustical enclosure is one of the standard features for all compressors.



Dismantling the compressor's enclosure may void its warranty.

**NOTICE!**



## 2.2 THE COMPRESSION CYCLE

The rotary screw oil-injected vacuum pump is a specific form of rotary positive displacement pump using a dual screw airend as the principal element in air compression.

The compressor housing contains two rotors; Male and Female rotor. The male rotor has five lobes and female rotor has six flutes. They are constantly and precisely meshed and housed in the cylinder with two parallel adjoining bores. All parts are machined to exacting tolerances. The rotors provide positive-displacement internal compression smoothly and without surging. As the rotors rotate, air is drawn into the cylinder through the inlet port. A volume of air is filled and trapped as the rotor lobes pass the inlet port in the cylinders. Compression occurs as the male rotor rolls into the female flute, progressively reducing the space thereby raising the pressure. Compression continues until the lobe and flute pass the discharge port. The compressed air is then discharged into the air/oil separator tank. There are five complete compression cycles for each complete rotation of the male rotor.

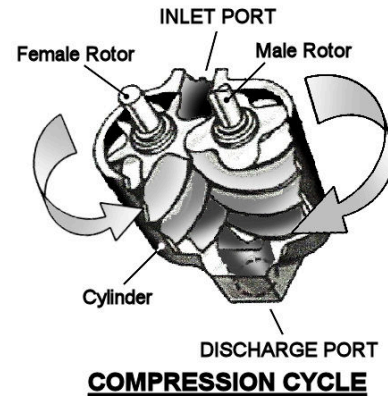

When the compressor is operating, a partial vacuum is produced at the compressor inlet. Fluid is injected into the compressor unit and mixed with the air. The fluid has three basic functions:

- As a coolant, it controls the rise in air temperature normally associated with the heat of compression.
- It seals the leakage paths between the rotors and stator and between the rotors themselves.
- It acts as a lubricating film between the rotors allowing one rotor to directly drive the other, which is an idler.

After air/fluid mixture is discharged from compressor to the reservoir, fluid is separated from the air in the separator tank. Compressed air then flows through the after-cooler for moisture removal while the lubricant is being cooled by the fluid-cooler for re-injection.

## 2.3 MOTOR

The main motor is a variable speed induction motor. Operating conditions of the variable speed motor are as follows (may vary with different countries).

Ambient temperature  $\leq 40^{\circ}\text{C}$

Altitude  $\leq 1000\text{m}$

Main motor transmit power to airend through a flexible, vibration-reducing coupling. There should be no intermittent or unusual noises or vibrations when the motor is running during unload or load condition.

The voltage and frequency of power source for the motor is indicated on the nameplate, the motor can be operated continuously at the rated power  $\times$  service factor. If the frequency of the power source deviates from the rating value indicated on the nameplate by 2% of this value, or under voltage/overvoltage exceeds 10%, there can be no guarantee that the motor will deliver rated output power.

## ***2.4 COMPRESSOR LUBRICATION AND COOLING SYSTEM***

The lubrication and cooling system consists of a reservoir, centrifugal fan, fan motor, aluminum finned fluid-cooler and after-cooler, thermal valve (or variable speed fan drive) and fluid filter. High pressure forces the lubricant through a series of direction changes in the reservoir where it is separated from the air. The fluid is then delivered to the thermal valve and fluid-cooler. Cooled fluid will be filtered before being re-injected back into the compressor.

The thermal valve is a directional valve with a temperature sensitive device. The thermal valve fully closes the access to the fluid cooler when the fluid temperature is below 70°C (158°F). Fluid (below 158°F) will bypass the fluid cooler, flow through fluid filter and re-inject into the airend. As the fluid temperature rises continually up to 80°C (176°F), due to heat of compression, the thermal valve begins to operate, and fluid will flow through the fluid cooler.

Ambient air is being forced through the cooler fins by the centrifugal fan, which cools the fluid and compressed air in the cooler tubes. The after-cooler helps separate the water content in the discharge air, and through the automatic condensate drain, the water will be drained. This avoids water contamination problems downstream (in service lines). Cooler fins must be kept clean at all times.

For the air-cooled units power in the range of 110kw to 250kw, fluid from reservoir circulates to oil fluid-cooler directly. There is no thermal valve equipped for these motor ranges. A fan drive controls the fan motor speed up and down to meet discharge target temperature.

## ***2.5 COMPRESSOR DISCHARGE SYSTEM***

Air/fluid mixture is forced into reservoir after compression. The reservoir has two basic functions:

- It acts as a primary fluid separator.

- It serves as the compressor fluid sump.

The compressed air/fluid mixture enters the reservoir and is directed against the internal baffle. Turbulent flow occurs, and velocity is significantly reduced, thus causing large droplets of fluid to form and fall to the bottom of reservoir. Fluid collected in the reservoir will then be returned to the compressor due to the pressure differential.

The sight glass enables the operator to visually monitor the reservoir fluid level. Fluid is added to the reservoir by removing the fluid filling cap after all system pressure is relieved. The fluid level should remain at the top red line on the sight glass. Fluid refill is required once its level drops below the lower red line.

The minimum pressure check valve of KRSL units assures the reservoir maintains a minimum pressure between 7psig and 15psig (0.5Bar and 0.7Bar) during unloading conditions. The minimum pressure check valve of KRSL units assures the reservoir maintains a minimum pressure between 15psig and 25psig (1Bar and 1.7Bar) during unloading conditions. This pressure is necessary for air/fluid separation and fluid circulation.

## 2.6 AIREND, INLETVALVE AND FILTRATION SYSTEM

The compressor inlet system consists of an air filter, inlet valve, & **SKY** airend. The inlet valve controls the air intake volume. It also acts as the check valve to prevent the reverse pressure and rotation when the compressor is shutting down.

① <b>SKY</b> air end
② inlet valve
③ Casing for air filter

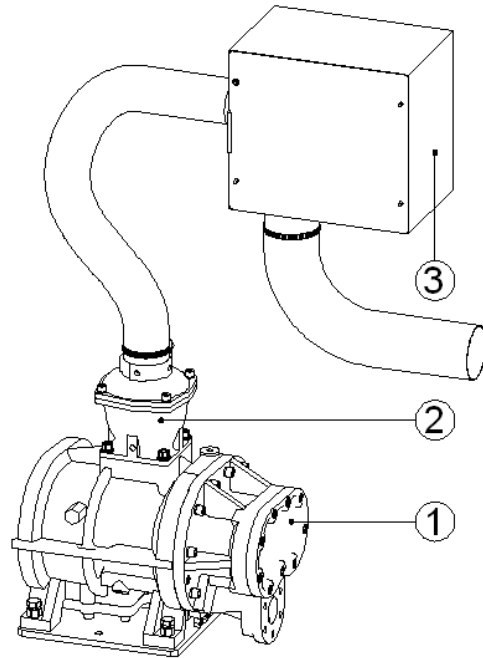

## Fluid Information

---

### 3.1 FLUID GUIDE

KRSL compressors are filled & tested with Kaishan lubricant. Refer *Figure 3-1* for filler port, sight glass, quarter-turn valve location on the reservoir. The compressor is filled with the manufacturer's recommended quantity of Kaishan fluid. Inspection of the reservoir fluid level during installation or operation is recommended.

①	Air/Oil Separator Tank
②	Fluid Fill Port
③	Sight Glass
④	Fluid Drain Valve

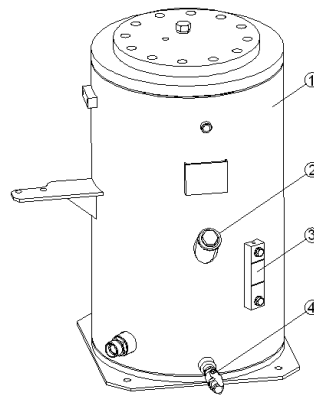

*Figure 3-1: Fluid Fill Location*



Do not use different fluid. Using different fluid will void compressor's warranty.

### 3.2 FLUID CHANGE RECOMMENDATIONS

<b>LUBRICANT</b>	<b>FLUID CHANGE</b>	<b>FLUID FILTER CHANGE</b>	<b>SEPARATOR CHANGE</b>
KTL8000	Every 8,000 hours or as indicated by sampling report	Every 2,000 hours or as indicated by Delta P	Every 8,000 hours or as indicated by Delta P
KTL4000 FG	Every 4,000 hours or as indicated by sampling report	Every 2,000 hours or as indicated by Delta P	Every 8,000 hours or as indicated by Delta P

## **Installation**

#### ***4.1 COMPRESSOR MOUNTING, SUPPORT AND LOCATION***

The compressor should be located on a flat surface in a clean, well-lit and well-ventilated area. The location must have sufficient access for maintenance equipment and lifting vehicle. Four feet (4') of clearance around the compressor is recommended for daily inspection and easy access to all compressor components. The area must have sufficient lighting for technicians to safely operate the compressor as well as perform maintenance work. The location should be free from standing water.

The compressor's base must be installed on a level surface that can support the gross dead weight of the machine. Rubber pad with 5 - 15mm thickness or pliable material should be placed under the bottom of the base if floor surface is uneven or irregular.



Brand new compressor has “Orange Color” shipping bracket installed under aircend assembly. Please remove the bracket after the unit is installed.

#### **NOTICE!**



**WARNING**

Removal or paint over of safety labels will be a safety hazard. This could result in personal injury or property damage. Warning signs and labels should be conspicuous and on a bright legible surface. Do not remove any warning, caution or instructional material attached with unit.

#### ***4.2 VENTILATION AND COOLING***

Ambient temperature should not exceed 40°C (104°F). High ambient temperatures may result in high air temperature shutdown.



Compressor must be equipped with high-ambient option if operating temperature exceeds 40°C (104°F).

#### **NOTICE!**



Do not install and operate compressor if the ambient temperature is below 5°C (41°F). Pre-heat option must be installed with the unit for lower ambient temperatures.

#### **NOTICE!**

The compressor air inlet must be located in the opposite direction to other compressors or heat generating equipment. The object is to avoid hot air being drawn into the system. Do not block the exhaust air from cooler or fan. Hot exhaust air must be vented outside through a duct to prevent high ambient room temperature. The compressor room must be properly ventilated to avoid compressor high temperature shutdown.



Maintain clean & fresh air, dust free, metal particle free and chemical vapor free in the compressor's room. Housing the compressor within a poorly ventilated enclosure will cause higher operating temperature.



Under no circumstances should a compressor be installed in an area exposed to toxic, volatile or corrosive atmosphere, nor should toxic, volatile or corrosive agents be stored near the compressor.

All models are intended for indoor installation; however, it is possible, with certain modifications, to accommodate some outdoor locations. Models with standard enclosure are water-resistant but not water tight. Shelter is needed to protect the unit from rain, snow and freezing temperatures. An optional weather hood or air grille could be installed to protect compressor against blowing rain and snow as well as cabinet heater additions if ambient temperature will be below 2°C (35 F).

### ***4.3 PIPING CONNECTION***

Before installation, review the complete air systems layout, which includes vacuum pump(s) and all related components. Never use PVC pipe or non-genuine rubber hose in the vacuum distribution system. Use flexible connections to prevent pipe load from being transmitted to the vacuum pump. It is very important to use adequate pipe diameter for the vacuum network, pipe size specified by the manufacturer for the vacuum pump unit is recommended.

A service line shut off valve must be installed after the compressor air outlet connection with a pressure relief valve installed to release compressed air to the atmosphere. For a single compressor and air receiver tank, manual shut off valves are typically being installed. A union connector must be installed after the ball valve (quarter turn, shut off valve) at the compressed air outlet. This will allow unit isolation for maintenance.





Release system pressure by opening manual pressure relief valve prior to servicing. Failure to relieve system pressure could result in death or serious injury and property damage.

The compressor after-cooler comes with an automatic condensate drain. The drain line should be installed to remove the condensate during compressor operation.

A receiver tank should be installed if compressed air demands fluctuate. Service line piping is recommended to be sized to match the compressor's discharge connector. All piping & fittings should be rated to withstand greater pressure than the discharge pressure. Isolation valves & drain valves are installed to isolate the compressor when service is required. These valves should have water drip legs with the drain direction facing downward to the floor. Piping should all line up properly with an adequate loop radius or bend radius given for easy installation and to prevent bending stress, flow restriction and damage due to thermal expansion. Piping support brackets must be mounted independent of the compressor and motor. This will avoid damage caused by vibration.

Pressure relief valves are sized to protect the system. Never change the pressure setting or tamper with the valve. Only the valve manufacturer and their authorized representatives are allowed to make such changes.



Pressure relief valves are used to protect system integrity in accordance with safety standards. Failure to provide properly sized valves will result in death or serious injury.

Pressure relief valves are installed prior to any potential blockage point such as shutoff valves, heat exchangers and discharge silencers. Ideally, the valve should be threaded directly into the pressure point it is sensing, not connected with tubing or pipe. Always direct discharge from relief valves to a safe area away from personnel.

#### ***4.4 FLUID LEVEL INSPECTION***

Inspect the fluid level when the compressor is in shut down mode to make sure fluid has not leaked from the unit during transport. Fluid level is indicated on the reservoir sight glass. When the compressor is running, the level should not exceed the top red mark on the sight glass.

## ***4.5 ELECTRICAL***

Before installation, the electrical supply should be checked for adequate wire size and capacity. User must comply with national & local electrical codes. The codes specify the surrounding clearance requirement for the electrical panel. Wiring work should be undertaken only by a qualified electrician in compliance with OSHA, national or local electrical code. KRSL compressors provide wiring diagrams for user reference. Refer to the electrical control schematic in the parts manual for wiring diagrams. A dedicated and fused disconnect switch or circuit breaker should be purchased for the installation. Any unreasonable voltage imbalance (5%) between phases must be eliminated and low voltage problems must be corrected to prevent excessive current draw. Air compressors must be grounded in accordance with applicable codes, regulations and requirement.



Kaishan Compressor would like to emphasize the importance of providing adequate grounding for air compressors. The common practice of grounding units to a building's structural steel may not provide adequate grounding protection, as paint and corrosion build-up may exist.



All electrical supply cables must be adequately sized to prevent overheating due to current draw.





Enclosure panels and drive grille must be fastened in place before starting the compressor and never removed before lock out / tag out of the main power supply.

A knock out is provided for an incoming power connection. If a different location for the starter hole is needed, the certified technician must make sure to keep control box clean after the hole is created. The original hole must be capped if another hole is used. Inspect incoming voltage to match the compressor's specification. Inspect motor starter and overload heater sizes. Check all electrical connections L1-L2-L3 for tightness and cleanliness.

## ***4.6 MOTOR ROTATION INSPECTION***

Motor rotation must be checked after the wiring has been installed. Operating the compressor in incorrect rotation will result in severe damage to the compressor and warranty coverage will be voided. Motor rotation can be viewed through the opening in the drive grille. The drive motor end of the compressor is marked with an arrow noting the proper rotation.

To inspect rotors rotation, pull out the EMERGENCY STOP  button and press once, quickly press the START  and STOP  button in sequence, allowing the motor to turn 2 or 3 revolutions. Observe the drive shaft for correct direction. If reverse rotation is observed, disconnect the power supply, reverse power input leads at the motor starter. Recheck for proper rotation.

#### ***4.7 FAN ROTATION INSPECTION***

Fan motor rotation should be inspected. KRSL compressors uses a centrifugal fan for cooling. Fan rotation is inspected through an arrow shaped observation hole above the fan motor. The fan must rotate in the direction indicated by the arrow.



Always inspect fan rotation through the observation hole. Never assume the fan rotation is correct based on the induced air flow across the coolers. A centrifugal fan can pull the airflow across the coolers when rotating in either direction; however, incorrect rotation will cause high discharge temperature.

#### **NOTICE!**

# Compressor Controller Operation

## 5.1 BASIC OPERATION

### 5.1.1. Screen display and basic operation

Power up screen:



Boot up screen, after 5 seconds:



Normal display screen:



- Line Pressure
- Discharge Temperature
- Current
- Voltage
- Fan Status
- Compressor Status
- Total Run Hours
- Total Load Hours

Icon touch screen display:



- Run Parameters
- User Parameters
- Factory Parameters
- Calibration Set
- Sequence Parameters
- Configuration Parameters
- Maintenance Parameters
- VSD Settings
- Touch Calibration
- Schedule Setup
- Schedule Activate
- Fault History
- Motor VSD
- Fan VSD
- Date and Time Set
- Return

## Controller LED indication

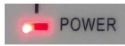

Power: Is on when controller is powered on.



Run: Is on when motor is running.

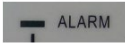

Alarm: Is blinking when compressor is alarmed. Is on when compressor is alarmed and stopped. Is off when errors have been cleared and reset.

### 5.1.2 Push button functionality



Push to Start Compressor.

When in Sequence Mode and Master Compressor, push to activate the Sequence Mode.



Push to Stop Compressor.

When in Sequence Mode and Master Compressor, push to de-activate the Sequence Mode.



Push to Load and Unload compressor when in running state.

Push to save data when modifying text box.

When on Icons Page, push to execute the corresponding function.



When Controller is in Alarm, press and hold for 5 seconds to Reset.

Push this button to allow data in textbox to be modified.

Push to return to previous menu.



Moves the cursor to the left.

On Icons page press to move to the next Icon.



Moves the cursor to the right.

When on the Icons page press to move to the previous Icon.



When on Icons page press to move down to the next row.

When modifying values press to decrease.

When viewing RUN data press to scroll down to the next page.



When on Icons page press to move up to the next row.

When modifying values press to increase.

When viewing RUN data press to scroll up a page.

### 5.1.3 Icons display and functions



If activated, the following Icons will appear on the Normal Run Screen:



A Time Schedule has been set.



A Pressure Schedule has been set.



Auto Restart is engaged.



Remote Stop/Start activated.



Computer Visualization set.



Multi-Unit Sequence Control activated.

## 5.2. PROGRAM STRUCTURE

Controller has 14 specific data zones; each zone is password protected.

Other than RUN and USER PASSWORDS, only authorized and trained personnel should have access to other specific zones.

FUNCTION	PASSWORD
RUN	NO PASSWORD
USER	9999
MAINTENANCE	6842

### 5.2.1 Run menu

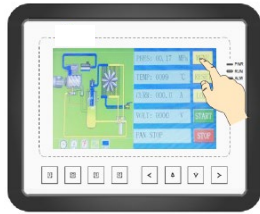

Press menu



Press RUN PARA

MENU	VALUE	FUNCTION
Air Pressure	00.80MPa	Display air pressure
Discharge Temperature	00075°C	Display discharge temperature
System Pressure	00.75MPa	Display system pressure
Oil Pressure Differential	00.55MPa	Display oil pressure differential
Front Rotor T	0065°C	Display front rotor temperature
Rear Rotor T	0065°C	Display rear rotor temperature
Oil Filter	0020H	Display Running Time of Oil Filter Element
Air/Oil Separator	0020H	Display Running Time of Air/Oil Separator Element
Air Filter	0020H	Display Running Time of Air Filter Element
Lube	0020H	Display Running Time of Compressor Lubricant
Grease	0020H	Display Running Time of Main Motor Grease
Serial Number	123456789	Compressor serial number
Drain Close Time (S)	0060	Time set for Condensate Drain to stay closed
Motor current	A: 000.0A B: 000.0A C: 000.0A	Display motor current
Fan current	A: 000.0A B: 000.0A	Display Fan current

	C: 000.0A	
MENU	VALUE	FUNCTION
Production Date:		Build Date
This run time	0000:00:00	Display Total run hours
This load time	0000:00:00	Display Total load hours
Software		Revision number
Check 1: 0000 0000		Check 2: 0000 0000
Digital inputs	1 2 3 4 5 6 7 8 9 10	
	o o o o o o o o o o	
	1: Refer to Digital Input 24	Emergency Stop
	2: Refer to Digital Input 23	Multi Functional
	3: Refer to Digital Input 22	Low Water Flow
	4: Refer to Digital Input 21	Oil Filter DP
	5: Refer to Digital Input 20	Separator DP
	6: Refer to Digital Input 19	Air Filter DP
	7: Refer to Digital Input 18	Multi Functional
8: Refer to Digital Input 17	Remote On/Off	
Digital outputs	1 2 3 4 5 6 7 8 9 10	
	o o o o o o o o o o	
	1: Refer to Digital Input 43	Emergency Stop
	2: Refer to Digital Input 42	Multi Functional
	3: Refer to Digital Input 41	Low Water Flow
	4: Refer to Digital Input 40	Oil Filter DP
	5: Refer to Digital Input 39	Separator DP
	6: Refer to Digital Input 38	Air Filter DP
	7: Refer to Digital Input 36	Multi Functional
	8: Refer to Digital Input 33	Compressor Running
9: Refer to Digital Input 32	Compressor Fault	
10: Refer to Digital Input 31	Compressor Alarm	
Motor Rated Speed	0000 RPM	Display Motor actual RPM based on the calculation of motor frequency read
Motor Rated Power	000.0 Hz	Display Inverter output Frequency
Motor Output Current	000.0 A	Display Inverter Output Current
Motor Output Voltage	000.0 V	Display Inverter Output Voltage
Motor Output Power	000.0 KW	Display Inverter Output Power
Motor Power Consumption	000.0 KW/Hr	Display Power Consumption in Real Time
Motor Power Total Consumption	000.0 KW/Hr	Display accumulative Power Consumption
Motor State Description	0000	Motor Running Status From Inverter data read
Error Description	0000	Motor Error Status from Inverter data read



Write Frequency	000.0	Motor Frequency based on PID calculations
MENU	VALUE	FUNCTION
Fan Speed	0000 RPM	Real Time Cooling Fan Speed based on frequency read
Fan Output Frequency	000.0 Hz	Display Output Frequency of Cooling Fan Inverter
Fan Output Current	000.0 A	Display Output Current of Cooling Fan Inverter
Fan Output Voltage	000.0 V	Display Output Voltage of Cooling Fan Inverter
Fan Output Power	000.0 KW	Real Time Cooling Fan Power from Inverter
Fan Power Consumption	000.0 KW/Hr	Display Fan Power Consumption in Real Time
Fan Power Total Consump.	000.0 KW/Hr	Display accumulative Fan Power Consumption
Fan State Description	0000	Fan Running Status from Inverter data read
Error Description	0000	Fan Error Status from Inverter data read
Write Frequency	000.0	Fan Frequency on PID calculations
PF Motor $\phi$ UI	000000.0VA	Display Motor Real Time kW
PF Motor This Elec.	000.0 KW/Hr	Display motor Real time power consumption
PF Motor Total Elec.	000.0 KW/Hr	Display motor Total run power consumption
PF Fan $\phi$ UI	0000.0VA	Display fan Real time KW
PF Fan This Elec.	000.0 KW/Hr	Display fan Real time power consumption
PF Fan Total Elec.	000.0 KW/Hr	Display fan total run power consumption

## 5.2.2 User menu

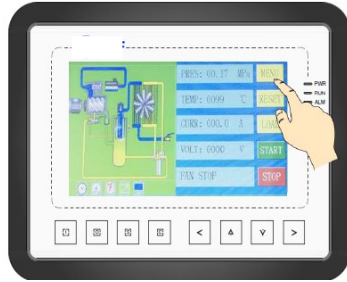

Press MENU



Press USER PARA

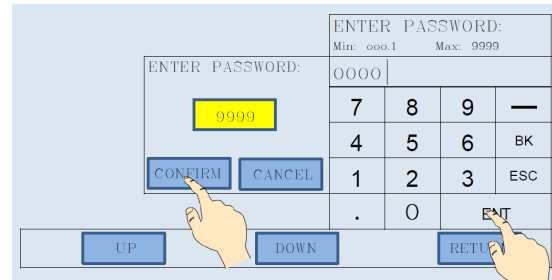
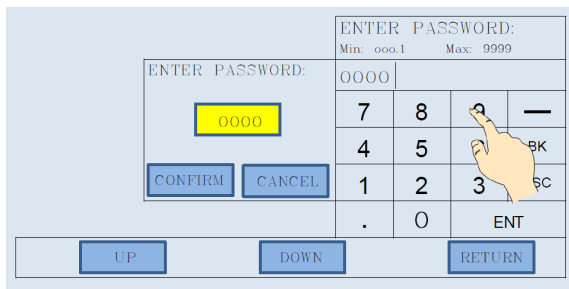

Enter the User password, press Enter and Confirm.

MENU	DEFAULT VALUE	FUNCTION
Load Pressure (MPa/PSI)	00.65/94.30	Load Pressure
Unload Pressure (MPa/PSI)	00.80/116.00	Unload Pressure
Fan Start T (°C/°F)	0080/176	Fan will start if Discharge Temperature is above this setting
Fan Stop T (°C/°F)	0070/158	Fan will stop if Discharge Temperature is below this setting
Motor Start Delay (S)	0008	Set to bypass Motor Overload protection on start up, the value here must be longer than the STAR DELAY TIME plus LOAD DELAY TIME
Fan Start Delay (S)	0003	Set to bypass Fan Motor Overload protection on start up
Star Delay (S)	0006	Star Delta changeover time
Load Delay (S)	0002	Delay to load after start running in Delta

MENU	DEFAULT VALUE	FUNCTION
Standby Delay (S)	0600	Compressor will stop after running continuously unloaded over this time
Stop Delay (S)	0010	Run on time after Stop Button pressed
Restart Delay (S)	0100	Will stop compressor from starting for the duration of this setting
Drain Open Time (S)	0002	Time set for Condensate Drain to open and purge
Drain Close Time (S)	0060	Time set for Condensate Drain to stay closed
Soft Start Delay (S)	0006	Controller starts Load delay time after this time setting
Load Mode	Manual/ Automatic	Manual Mode; Use Load/Unload Button. If pressure is above unload pressure compressor will unload automatically. Automatic Mode; Will load and Unload via Pressure Transducer.
Start Mode	Local/ Remote	Stop and start from MAM Controller/ Will start from MAM Controller and remote contacts
Run Mode	5 options	DOL, Motor VSD, Fan VSD, Motor Fan VSD, Soft Start
Comm Address	0001	Set the Communication address in Computer or Sequence Mode
Backlight Adjustment	0001	Set Controller backlight Level 1 - 4
Comm Mode	3 Options	Disable ~ Comm function not activated. Computer ~ Comm with computer or DCS with Modbus RTU Baud Rate 9600 Data Format 8NI Parity Bit. Even Sequence ~ Compressors work in a net.
Pressure Units	3 Options	MPa ~ PSI ~ Bar
Temperature	2 Options	°C or °F
Language	4 Options	English ~ Chinese ~ German ~ Spanish
User Password	****	Change User Password.
Sleep Backlight	0007	Turn off backlight if not in operation.
System P Delay	0060S	Check whether the system pressure is lower than the set low system pressure stop value after start delay lasts for this time.

To change a setting:

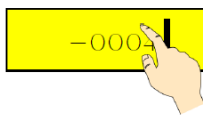
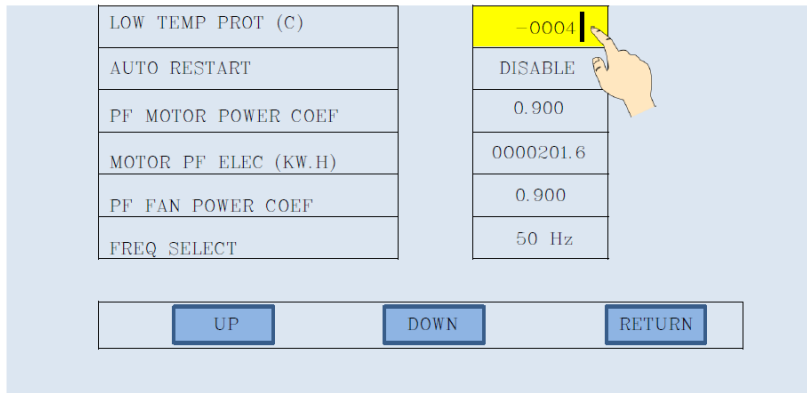

Highlight text to be modified



Press C to allow data modification – text will start flashing



Scroll values up or down



P Press S to set

### 5.2.3 Sequencing parameters

Press MENU, Press BLOCK PARA, enter the User password, press Enter and Confirm.

MAM 6090 has the capacity to control 16 compressors via a daisy chain RS485 series link utilizing RS485-1 terminals A1, B1 and GND1.

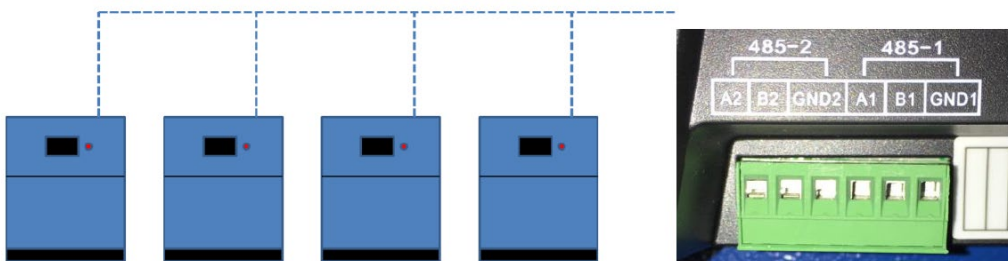

MENU	DEFAULT	FUNCTION
------	---------	----------

	VALUE	
Block Number	0002	Number of Compressors to Sequence.
Block Load Pressure (Mpa/PSI)	00.63 /91.00	In Sequence Mode One Compressor Will Start and Load when master air pressure is below this set data.
Block Unload Pressure (Mpa/PSI)	00.78 /113.00	In Sequence Mode One Compressor Will Stop or Unload when master air pressure is above this set data.
Block Delay (S)	0020	Delay to Start and Load More than One Compressor.
Turn Time (M)	0060	Time to Change Over Master and Slave Compressor.
Block Mode	PF – PF VSD – PF VSD - VSD	All Fixed compressors Variable and fixed combination All VSD's

To Set Master Control Compressor:

- a) Go to User Menu,
- b) Set COMM MODE to BLOCK
- c) Set COM ADD to 0001 for Master Unit
- d) After setting, turn off Controller and Reboot to save this setting.

To Set Slave Compressors:

- a) Go to User Menu
- b) Set COMMS MODE to BLOCK
- c) Set COM ADD to 0002 - 16 for Slave Unit
- d) The Sequence BLOCK Icon will appear on the Controller Screen

To Start / Stop Sequence BLOCK MODE:

- a) To activate BLOCK MODE start Master compressor first.
- b) Start each of the Slave units in turn.
- c) Allow the Compressors to Start and Stop themselves according to the settings already programmed.
- d) Stopping the Master compressor manually will deactivate the BLOCK Control.

Network Connection:

The MAM 6090 Controller supports MODBUS RTU protocol.

It supports 03, 06, 16 MODBUS commands.

Communication baud rate 9600 BPS

1 Start bit

8 Data bits

1 Stop bit  
Even Parity

### 5.2.4 Maintenance parameters

Press MENU, press MAIN PARA, enter the password, press Enter and Confirm.

MENU	DEFAULT VALUE	FUNCTION
Oil Filter Run Time (H)	0000	Service of Oil Filter Real Time. When replacing oil filter it has to be manually reset.
Air/Oil Separator Run Time (H)	0000	Service of Separator Element Real Time. When replacing separator it has to be manually reset.
Air Filter Run Time (H)	0000	Service of Air Filter Real Time. When replacing air filter it has to be manually reset.
Lubricant Run Time (H)	0000	Service of Lubricant Real Time. When replacing oil it has to be manually reset.
Grease Run Time (H)	0000	Service of Grease Real Time. When greasing it has to be manually reset.
Oil Filter Max Run Time (H)	2000	Alarm Prompt Hours. Set to OOOO and function is disabled
Air/Oil Separator Max Run Time (H)	2000	Alarm Prompt Hours. Set to OOOO and function is disabled
Air Filter Max Run Time (H)	2000	Alarm Prompt Hours. Set to OOOO and function is disabled
Lubricant Max Run Time (H)	2000	Alarm Prompt Hours. Set to OOOO and function is disabled
Grease Max Run Time (H)	2000	Alarm Prompt Hours. Set to OOOO and function is disabled

The following alarms will occur from this maintenance menu if set parameters are exceeded:

ALARM	MENU	MESSAGE
Air filter alarm	Digital # 19	AIR BLOCK
	Maintenance	AIR TIME END
Oil filter alarm	Digital # 21	OIL BLOCK
	Maintenance	OIL TIME END
Separator alarm	Digital # 20	O/A BLOCK
	Maintenance	O/A TIME END
Lubricant alarm	Maintenance	LUBE TIME END
Grease alarm	Maintenance	GREASE TIME END

### 5.2.5 Touch screen calibration

Touch calibration is used to adjust touch accuracy.

Press MENU, press TOUCH CALIB, enter the password, press Enter and Confirm.

After entering touch calibration menu, use fingertip to click A , B ,C ,D in sequence. Press “S” button to restart and save the modification.

### 5.2.6 Scheduled pressure

SCH PRES menu will run the compressor within the Pressure Band within the boundaries of the P START and P STOP times programmed.

Outside the time boundary the compressor will go into Standby Mode and will not start even if the pressure drops below minimum setting.

Press MENU, press SCH PRES, enter the password, press Enter and Confirm.

MENU	DEFAULT VALUE	FUNCTION
Load P (Mpa)	00.65	Will Start and Load if Between Start and Stop Schedule Time Set if air pressure is below this setting.
Unload P (Mpa/PSI)	00.80/116.00	Will Unload if Between Start and Stop Schedule Time Set if air pressure is above this setting.
Scheduled VSD P (Mpa/PSI)	00.70/101.50	VSD Optimum Pressure Between Start and Stop Schedule Time Set (This data is only available in MOTOR VSD or MOTOR/FAN VSD mode).
P Start Time	00.00	Set Time to Activate Schedule. 00.00 Means not Activated.
P Stop Time	00.00	Set Time to Deactivate Schedule. 00.00 Means not Activated.

### 5.2.7 Schedule ON-OFF

Press MENU, press SCH WORK, enter the password, press Enter and Confirm.

SCH WORK is Time specific and can be programmed for up to 4 scheduled on/off periods per day. When set to 0000, the function is disabled.

### 5.2.8 History record

Select FAULT REC. Stores 100 faults in history file. Can be Reset in Factory Menu.

### 5.2.9 Date and Time

Select DATE. Set real time and date.

### 5.3. TECHNICAL DATA

1. Ambient: -20 ~ 60°C (-4 ~ 140°F).
2. Digital Inputs: 8.
3. Digital Output relays: 10 (250VAC ~ 5A capacity).
4. Analog Inputs: 3 x PT100.
5. Transducer Inputs: 2 x 4-20ma.
6. CTs Input: 2 x 3 phase groups.
7. Voltage Options: 460 / 400 / 220 VAC.
8. Controller Power Supply: 16-28VAC, 20VA.
9. RTD Range: -50 ~ 350 °C (-58 ~ 284°F).

TEMP. °C	TEMP. °F	Ohms
-20	-4.0	92.16
-10	14.0	96.09
0	32.0	100
10	50.0	104
20	68.0	107.79
30	86.0	111.67
40	104.0	115.54
50	122.0	119.4
60	140.0	123.24
70	158.0	127.07
80	176.0	130.89
90	194.0	134.7
100	212.0	138.5
110	230.0	142.29
120	248.0	146.06

10. Running Time: 0 ~ 999999 hours
11. Current: 0 ~ 999.9 A
12. Pressure Transducer: 0 ~ 16 bar (0~232PSI), 4-20mA, 28VDC.
13. RS485 port 1: For Sequence or Computer communication.
14. RS 485 port 2: For Inverter control.
15. Phase reversal protection response time  $\leq 1$  s.



16. High temperature response time  $\leq 2$  s.

17. Overload protection response time:

I actual / I set	$\geq 1.2$	$\geq 1.3$	$\geq 1.5$	$\geq 1.6$	$\geq 2.0$	$\geq 3.0$
Response time (s)	60	48	24	8	5	1

#### 5.4. TROUBLESHOOTING

FAULT	PROBABLE REASON	REMEDY
High discharge temperature	Bad vent condition, Oil shortage etc.	Check the vent condition, lubricant level, etc.
Temperature Sensor Failure	Cable broken or PT100 failure	Check the wiring and PT100.
High Pressure	Pressure too high or pressure sensor failure	Check the pressure and the pressure sensor.
Pressure Sensor Failure	Cable broken, Sensor failure or the cables connect reversely	Check the wiring and pressure transmitter.
Open Phase	Power open phase or contactor failure	Check the power and contactors.
Overload	Voltage too low, tubes block, bearing wear off or other mechanical failure or wrong set data etc.	Check the set data, voltage, bearings, tubes and other mechanical system.
Unbalance	Current unbalance, contactor failure or the internal open loop of the motor	Check the power, contactor and the motor.
Wrong Phase Sequence	Phase sequence reversal or open phase	Check the wiring.
Motor overload during start	Master start time set to less than the star delta delay time	Reset the master start time longer than star delay + 2 seconds.
Main Contactor shakes frequently	The emergency stop button is loose or controller is reset by interference	Check if the coil of contactor connects with RC snubber or not.
Inverter Communication Fault	Wrong set of relatively parameter of controller and Inverter; Communication cable loose	Check the set data; Check the cable.

## Servicing

KRSL compressors require the minimum amount of inspection and maintenance. The controller and indicator alert the operator to perform required maintenance or repair unit problems.

## **6.1 FLUID CHANGE**

KRSL series compressors utilize a pressurized fluid drain. Use the following procedure to drain and replace the compressor fluid.

- i. Run the compressor for a while to warm the lubricant.
- ii. Stop the compressor, power off.
- iii. Open drain valve on separator tank and fluid cooler, plug in drain hose.
- iv. Drain oil in a container or waste dedicated pipeline
- v. Close drain valve
- vi. Unscrew the plug on airend discharge pipe and drain oil in a container or waste dedicated pipeline. Refit the plug.
- vii. Remove oil filter, drain oil, replace with a new part.
- viii. Remove the plug from the fluid fill port and refill the reservoir with the appropriate amount of KTL8000 fluid. Refit and tighten the plug.
- ix. Power on and start up compressor for a few minutes, shut down.
- x. Unscrew the plug from the fluid fill port and refill the reservoir to the adequate level



### **NOTICE**

The 1/4 turn valve on the blow-down valve **MUST** be open for the unit to blow down during regular unit operation.

## **6.2 AIR FILTER**

The standard Kaishan air filter is a single stage, dry type element. Air filter maintenance should be performed by the the maintenance gauge shows red with the compressor running full load, or every 4000 hours, or once a year, whichever comes first. Daily cleaning of the filter element is common in dirty conditions. If dirty conditions exist, it is advisable to relocate the intake air to an outside source. Each time the filter is serviced, inspect the filtered air side of the air cleaner canister and the suction manifold for dirt. If dirt is found, determine the cause and correct. Always make sure all gaskets, threaded connections, flange connections, and hose connections between the air filter and air compressor-are airtight. Dirty filters result in reduced airflow and can distort the element and allow dirt to bypass the filter element.



### **NOTICE**

Intake filtration equipment supplied from the factory may not be adequate for extremely dirty applications or some forms of dust or vapors. It is the customer's responsibility to provide adequate filtration for those conditions. Warranty will be voided if inadequate filtration causes a failure.

### 6.3 FLUID FILTER

The fluid filter is a spin on, full flow unit. Replacement of the filter requires spinning off the cartridge and replacing it with a new one. During normal service, the filter cartridge should be replaced under the following conditions, whichever occurs first:

- ◆ As indicated by the fluid filter maintenance indicator when the fluid is at normal operating temperature
- ◆ Every 2,000 hours
- ◆ Every fluid change



#### NOTICE

The fluid filter maintenance indicator may read high upon start up on cool mornings due to sluggish fluid creating higher than normal differential pressures. Monitor indicator after the fluid warms up.

### 6.4 AIR/OIL SEPARATOR

The air/oil separator is using coalescent filter element. Replacement requires unbolting and lifting the separator cover and replacing it with a new one. The air/oil separator should be replaced as indicated in the maintenance schedule or as follows:

- ◆ If excessive fluid carryover is observed.
- ◆ 8,000 hours MAX, or-as indicated by differential pressure indicator.
- ◆ As indicated by the gauge (if equipped).

### 6.5 FLUID SAMPLING PROCEDURE

KRSV models are required performing oil sample procedure every 2000 h. The following is a sampling procedure, with fixed sampling hardware installed.

- i. Take sample at normal operating conditions
- ii. Hold the oil drain hose into lubricant sample bottle.
- iii. Slowly open the sample valve.
- iv. Collect oil, avoid overfilling the sample bottle.
- v. Close the sample valve.
- vi. Seal the bottle tightly, wipe clean.
- vii. Pre-label or label sample bottle immediately after filling to avoid mix-ups. Make sure bottles are labelled with full sample details.

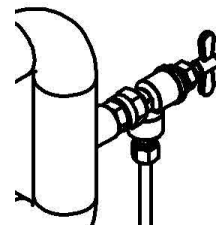

## 6.6 MAINTENANCE SCHEDULE

This Schedule is intended to be used as a guideline only. Depending on the specific operating conditions of your KRSL compressor, maintenance requirements may vary. The instructions in this section will give more details about determining when specific service should be performed.

First 500 hours	Change fluid filter and check fluid level
Every 500 hours	Drain water from air/oil separator tank. Check fluid level Clean air filter Clean after-cooler fins. Check for loose fluid and air tubing, electrical wiring connection.
Every 1000 hours	Clean air filter or replace with new element. Clean after-cooler fins.
Every 2000 hours	Check fluid level. Check safety valve Replace fluid filter. Perform fluid sampling
Every 4000 hours	Clean after-cooler fins. Check fluid level. Replace air filter.
Every 8000 hours	Check equipment power supply and earth-grounding. Replace air/oil separator. Replace fluid.

## Troubleshooting Guide

---

Information below is a troubleshooting guideline; it describes symptoms and possible cause. Do not assume that these are the only faulty condition that may occur.

**Table 8-1: TROUBLE SHOOTING GUIDE**

<b>Symptom</b>	<b>Possible Cause</b>	<b>Solution</b>
Fail to Start	Power failure	Check power supply to the unit
	Low incoming voltage	Check voltage and power source or contact local power company.
	Fuse blown	Replace Fuse
	Faulty start switch	Check the switch for malfunction or loose connection.
	Emergency button	Reset emergency button
	Motor starter overload tripped	Check motor starter wiring before removing motor. Remove motor and have tested at motor manufacturer repair center.
	Loose wire connections	Check all wiring terminals for contact and tightness
	Air-end failure	Contact a local authorized distributor.
Compressor shuts down during loaded condition	High ambient temperature	Make fresh air intake openings or install ducts to discharge the hot air.
	Low incoming voltage	Check voltage and power source or contact local power company.
	High operating pressure	Reset, check line pressure and ensure it does not exceed the compressor's maximum operating pressure.
	Low fluid level	Top-up fluid
	Display separator requires maintenance	Replace separator element.
Line pressure rises above unload pressure set-point	Control system air leakage	Check for leak
	Air filter blocking	Replace air filter element
	Air Intake valve stuck open	Remove the intake hose and check the inlet valve for proper operation
	Defective blow-down valve	Check the receiver tank to ensure that it is exhausting air to the atmosphere when the solenoid opens - repair or replace if necessary.
<b>Symptom</b>	<b>Possible Cause</b>	<b>Solution</b>
Compressor does not reload when service line pressure drops	Faulty solenoid	Repair or replace as necessary
	Loose wiring connection	Check and tighten wiring terminals
	Faulty proportional valve	Orifice plugged. Clean or replace as necessary
	Jammed air inlet valve assembly	Check and repair air inlet valve

to reset	Faulty air pressure sensor	Repair or replace as necessary
High air discharge temperature	Low Fluid Level	Check oil level
	Incorrect fluid brand	Check oil code number, replace as necessary
	High ambient temperature	Check air exhaust, reduce room temperature.
	Plugged oil filter	Change oil filter
	Plugged internal aftercooler	Chemical cleaning for after-cooler
	Dusty after-cooler fins	Chemical wash for after-cooler fins
	Fan motor setting	Adjust
	Temperature sensor failure	Check and replace as necessary
	Loose wire	Check and tighten
Low air capacity delivery	Plugged air filter	Clean air filter or replace with new element
	Air Intake valve failure	Remove the intake hose and check the inlet valve for proper operation
	Separator failure	Replace separator element
	Faulty indirect proportional valve	Adjust or replace as necessary
	Faulty solenoid	Repair or replace as necessary
	Faulty safety valve	Repair or replace as necessary
Excessive oil carry over in discharge compressed air.	High oil level	Check oil level
	Scavenging line blocked	Clean or replace as necessary
	Low discharge pressure	Adjust
	Air/oil separator element failure	Clean or replace as necessary
	Minimum pressure valve malfunction	Check for leaking, replace as necessary
Loading function Failure	Solenoid valve failure	Check and replace as necessary
	Pipe leak	Check and replace as necessary
	Proportional valve failure	Check and replace as necessary
	Air Intake valve stuck open	Remove the intake hose and check the inlet valve for proper operation
	Minimum pressure valve failure	Check for leaking, replace as necessary
<b>Symptom</b>	<b>Possible Cause</b>	<b>Solution</b>
Unloading failure at working pressure, causing safety	Pressure loading setting	Adjust as necessary
	Solenoid valve failure	Check and replace as necessary
	Plugged air/oil separator	Check and replace as necessary
	Air Intake valve stuck open	Remove the intake hose and check the inlet valve for proper operation
	Safety valve failure	Repair or replace as necessary

valve to release pressure	PLC controller failure	Check and replace as necessary
Compressor air discharge pressure below normal operating settings	Plugged air filter	Clean or replace as necessary
	Air Intake valve stuck closed	Remove the intake hose and check the inlet valve for proper operation
	Plugged air/oil separator	Check or replace as necessary
	Indirect proportional valve setting	Adjust or replace as necessary
	Solenoid valve failure	Check and replace as necessary
	Safety valve failure	Check and replace as necessary
Short period of load/unload	Pipe leak	Check and replace as necessary
	Pressure setting	Change setting above 1Bar
	Receiver tank too small	Check or increase volume of receiver tank
	Air flow into the main network restricted	Increase pipe size. Checks filter cartridge failure.
Oil vapor leak from air filter when compressor stops	Air inlet valve failure	Check and replace as necessary
	Minimum pressure valve failure	Check for leaks and replace as necessary
	Pressure relief valve failure	Check and replace as necessary
Excessive Fluid Consumption	Different oil is being used.	Use KRSL genuine fluid.
	Separator element damaged	Check and replace as necessary.
	Oil level too high	Drain off oil until the correct level.
	Fluid foaming	Drain off oil and change
	Oil return line or orifice clogged	Clean and replace as necessary.

## Standard Terms and Conditions

---

These terms and conditions govern the sale of Products (“Rotary Screw Air Compressors and parts”) and provisions of services by Kaishan Compressor USA (Seller) and its authorized representative or buyer. These terms and conditions (“Agreement”) take precedence over Buyer’s supplemental or conflicting terms and conditions to which notice of objection is hereby given. Neither Seller’s commencement of performance or delivery shall be deemed or construed as acceptance of Buyer’s supplemental or conflicting terms and conditions. Kaishan Compressor USA’s failure to object to conflicting or additional terms will not change or add to the terms of this agreement. Buyer’s acceptance of the Products and/or Services from Seller shall be deemed to constitute acceptance of the terms and conditions contained herein.

**Orders:** All orders placed by Buyer are subject to acceptance by Seller. Orders may not be canceled or rescheduled without Seller’s written consent. All orders must identify the products, unit quantities, part numbers, applicable prices and requested delivery dates of the Products being purchased. Seller may at its sole discretion allocate Product among its Buyer. Seller may designate certain Products and Services as non-cancelable, non-returnable and the sale of such Products shall be subject to the special terms and conditions contained in Seller’s Customer Acknowledgement or Non-Returnable Product Form, which shall prevail and supersede any inconsistent terms and conditions contained herein or elsewhere.

**Prices:** The prices of the Products are those prices specified on the front of the invoice or contained within an agreed written contract. Price quotations shall automatically expire in thirty (30) days from the date issued, or as otherwise stated in the quotation.

**Taxes:** Unless otherwise agreed to in writing by Seller, all prices quoted are exclusive of transportation and insurance costs, duties, and all taxes including federal, state and local sales, excise and value added, goods and services taxes, and any other taxes. Buyer agrees to indemnify and hold Seller harmless for any liability for tax in connection with the sale, as well as the collection or withholding thereof, including penalties and interest thereon. When applicable, transportation and taxes shall appear as separate items on Seller’s invoice.

**Payment:** Payment may be made by check, money order, credit card, or wire transfer (all fees are borne by the Buyer). Where Seller has extended credit to Buyer, terms of payment shall be net thirty (30) days from date of invoice, without offset or deduction. On any past due invoice, Seller may impose a monthly interest rate. If Buyer fails to make the required payments the Seller will impose the interest rate each month. If Buyer fails to make each payment when it is due, Seller reserves the right to withdraw credit and thereby suspend or cancel performance under any or all purchase orders or agreements in which Seller has extended credit to Buyer. In the event of default by Buyer, Seller shall be entitled to costs, fees, and expenses including but not limited to recovery of attorney fees, court costs and fees, and collections costs.



**Delivery and Title:** The locations of shipment delivery will be made according to the Seller and Buyer agreement. Title and risk of loss pass to the Buyer upon delivery of the Product to the carrier. Seller's delivery dates are estimates only and Seller is not liable for delays in delivery or for failure to perform due to causes beyond the reasonable control of the Seller, nor shall the carrier be deemed an agent of the Seller. A delayed delivery of any part of an Order does not entitle Buyer to cancel other deliveries. Kaishan Compressor USA will comply with various federal, state and local laws and regulation concerning occupational health, safety and environment concerns. Buyer has full responsibility to comply with those laws and regulations during the installation and operation of the equipment.

**Acceptance / Returns:** Shipments will be deemed to have been accepted by Buyer upon delivery of the said shipments to Buyer unless rejected upon receipt. Buyer shall perform all inspections and tests. Buyer deems necessary as promptly as possible but in no event later than 7 days after receipt of Products, at which time Buyer will be deemed to have irrevocably accepted the Products. Any discrepancy in shipment quantity must be reported within 7 days after receipt of Products. Buyer may not return Products without a Return Material Authorization ("RMA") number. RMA's valid for 30 days from the date issued.

**Standard Warranty:** Buyer will honor Product warranties and indemnities authorized by the manufacturer, including any transferable. 90 days warranty is given for service parts from receipt date. Seller warrants to Buyer that Products purchased hereunder will conform to the applicable manufacturer's specifications for such products and that any value-added work performed by Seller on such Products will conform to applicable Buyer's specifications. If Seller breaches this warranty, Buyer's remedy is limited to (at Seller's election) (1) refund of Buyer's purchase price for such Product (without interest), (2) repair of such Products, or (3) replacement of such Products provided that such Products must be returned to Seller, along with acceptable evidence of purchase within 13 days from date of delivery, transportation charges prepaid. No warranty will apply if the Product has been subject to misuse, neglect, accident or modification.

**Limitation of Liabilities:** Buyer shall not be entitled to, and Seller shall not be liable for, loss of profit or revenue, promotional or manufacturing expenses, overheads expenses, business interruption cost, loss of data, removal or reinstallation costs, injury to reputation of buyer, punitive damages, loss of contractor orders or any indirect, special, incidental or consequential damages of any nature. Buyer's recovery from seller for any claim shall not exceed the purchase price paid for the affected products irrespective of the nature of the claim whether in contract, tort, warranty, or otherwise. Buyer will indemnify, defend and hold seller harmless from any claims based on (a) Seller's compliance with buyer's designs, specifications, or instructions, (b) Modification of any products by anyone other than Seller, or (c) use in combination with other products not supplied by seller.

**Use of Products:** Unless otherwise specified. Products sold by Seller are not designed, intended or authorized for use in life support, life sustaining, nuclear, or other applications in which the failure of such Products could reasonably be expected to result in personal injury, loss of life or catastrophic property damage. If buyer uses or sales the Products for use in any such applications: (1) Buyer acknowledges that such use or sale is at Buyer's sole risk; (2) Buyer agrees that Seller and the manufacturer of the Products are not liable, in whole or in part, for any claim or damage arising from such use; and (3) Buyer agrees to indemnify, defend and hold Seller and the manufacturer of the Products harmless from and against any and all claims, damages, losses, costs, expenses and liabilities arising out of or in connection with such use or sale.

**Force Majeure:** Seller is not liable for failure to fulfill its obligations for any accepted Order or for delays in delivery due to causes beyond Seller's reasonable control including, but not limited to, acts of God, natural or artificial disaster, riot, war, strike, delay by carrier, shortage of Product, acts or omissions of other parties, acts or omissions of civil or military authority, Government priorities, changes in law, material shortages, fire, strikes, floods, epidemics, quarantine restrictions, acts of terrorism, delays in transportation or inability to obtain labor, materials or products through its regular sources, which shall be considered as an event of force majeure excusing Seller from performance and barring remedies for non-performance. In an event of force majeure condition, the Seller's time for performance shall be extended for a period equal to the time lost as a consequence of the force majeure condition without subjecting Seller to any liability or penalty. Seller may, at its option, cancel the remaining performance, without any liability or penalty, by giving notice of such cancellation to the Buyer.

**General:** (a) Seller will comply with state law for any dispute from buyer. (b) Buyer may not assign this Agreement without the prior written consent of Seller. Seller or its affiliates may perform the obligations under this Agreement. This Agreement is binding on successor and assigns, (c) Products, including software or other intellectual property, are subject to any applicable rights of third parties, such as patents, copyrights and/or user licenses.

## Contact Information

---

Kaishan Compressor, LLC.,  
Add.: 15445 Industrial Park Dr., Loxley, AL, Post code: 36551  
Office number: +1 251-202-0577