

OPERATION AND PARTS MANUAL



MODELS:

ST2037

ST2047

ST2047B

ST2038P

ST2040T

SUBMERSIBLE PUMPS

Revision #3 (06/15/10)

To find the latest revision of this
publication, visit our website at:
www.multiquip.com



THIS MANUAL MUST ACCOMPANY THE EQUIPMENT AT ALL TIMES.

ST2037, 47, 47B, 40T, 38P SERIES SUB. PUMPS — TABLE OF CONTENTS

Multiquip ST2037, ST2047, ST2047B ST2038P and ST2040T Submersible Pumps

Table Of Contents	2
Parts Ordering Procedures	3
Here's How to Get Help	4
Safety Message Alert Symbols	5
Rules For Safe Operation	6-7
Dimensions	8
Specifications (Pump/Control Box)	9
General Information	10
Components	11
Float Switches	12
Float Switch (Piggy-Back)	13
Float Switch (Control Box)	14
Operation	15
Control Box Installation	16-17
Clean-up	18
Maintenance	19
Troubleshooting	20
Performance Curves	21
Pump Wiring Diagram	22
Explanation Of Codes In Remarks Column	24
Suggested Spare Parts	25

Submersible Pump Component Drawings

ST2037,ST2047, 2047B Pump Assembly	26-27
ST2040T Pump Assembly	28-29
ST2038P Pump Assembly	30-31

Terms and Condition of Sale — Parts	32
---	----

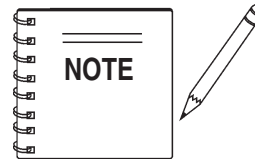

*As a continuing effort to update our parts book, contact the **MULTIQUIP** literature department for the latest revision of your "Operation and Parts Manual"*

PARTS ORDERING PROCEDURES

Ordering parts has never been easier! Choose from three easy options:

Effective:
January 1st, 2006

www.multiquip.com



Order via Internet (Dealers Only):

Order parts on-line using Multiquip's SmartEquip website!

- View Parts Diagrams
- Order Parts
- Print Specification Information



If you have an MQ Account, to obtain a Username and Password, E-mail us at: parts@multiquip.com.

To obtain an MQ Account, contact your District Sales Manager for more information.

Goto www.multiquip.com and click on **Order Parts** to log in and save!

Use the **internet** and qualify for a **5% Discount** on *Standard orders* for all orders which include complete part numbers.*

Note: Discounts Are Subject To Change



Order via Fax (Dealers Only):

All customers are welcome to order parts via Fax.

Domestic (US) Customers dial:
1-800-6-PARTS-7 (800-672-7877)

Fax your order in and qualify for a **2% Discount** on *Standard orders* for all orders which include complete part numbers.*

Note: Discounts Are Subject To Change



Order via Phone: Domestic (US) Dealers Call:
1-800-427-1244

Non-Dealer Customers:

Contact your local Multiquip Dealer for parts or call 800-427-1244 for help in locating a dealer near you.



International Customers should contact their local Multiquip Representatives for Parts Ordering information.

When ordering parts, please supply:

- | | |
|---|--|
| <input type="checkbox"/> Dealer Account Number | <input type="checkbox"/> Specify Preferred Method of Shipment: |
| <input type="checkbox"/> Dealer Name and Address | <input checked="" type="checkbox"/> UPS/Fed Ex <input checked="" type="checkbox"/> DHL |
| <input type="checkbox"/> Shipping Address (if different than billing address) | <input type="checkbox"/> Priority One <input checked="" type="checkbox"/> Truck |
| <input type="checkbox"/> Return Fax Number | <input type="checkbox"/> Ground |
| <input type="checkbox"/> Applicable Model Number | <input type="checkbox"/> Next Day |
| <input type="checkbox"/> Quantity, Part Number and Description of Each Part | <input type="checkbox"/> Second/Third Day |

NOTICE

All orders are treated as *Standard Orders* and will ship the same day if received prior to 3PM PST.

WE ACCEPT ALL MAJOR CREDIT CARDS!



ST2037, 47, 47B, 38P, 40T SUB. PUMP— SAFETY MESSAGE ALERT SYMBOLS

FOR YOUR SAFETY AND THE SAFETY OF OTHERS!

Safety precautions should be followed at all times when operating this equipment. Failure to read and understand the Safety Messages and Operating Instructions could result in injury to yourself and others.

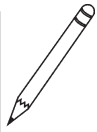
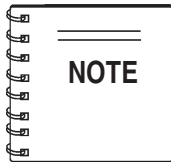

This Owner's Manual has been developed to provide complete instructions for the safe and efficient operation of the Multiquip *Model s* **ST2037, ST2047, ST2047B, ST2038P, and ST2040T Submersible Pumps.** Before using these pumps, ensure that the operating individual has read and understands all instructions in

this manual.

SAFETY MESSAGE ALERT SYMBOLS

The three (3) Safety Messages shown below will inform you about potential hazards that could injure you or others. The Safety Messages specifically address the level of exposure to the operator, and are preceded by one of three words: **DANGER**, **WARNING**, or **CAUTION**.

DANGER

You **WILL** be **KILLED** or **SERIOUSLY** injured if you **DO NOT** follow directions.

WARNING

You **CAN** be **KILLED** or **SERIOUSLY** injured if you **DO NOT** follow directions.

CAUTION

You **CAN** be **INJURED** if you **DO NOT** follow directions.

Potential hazards associated with the ST2037, ST2047, ST2047B, ST2038P, and ST2040T submersible pumps operation will be referenced with Hazard Symbols which appear throughout this manual, and will be referenced in conjunction with Safety Message Alert Symbols.

HAZARD SYMBOLS



Rotating Parts



NEVER operate equipment with covers, or guards removed. Keep fingers, hands, hair and clothing away from all moving parts to prevent injury.



Accidental Starting



ALWAYS place the power source circuit breaker or ON/OFF switch in the **OFF** position, when the pump is not in use.



Sight and Hearing hazard

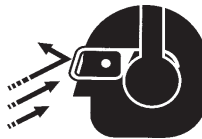

ALWAYS wear approved eye and hearing protection, if required.



Respiratory Hazard



ALWAYS wear approved respiratory protection, if required.



Equipment Damage Messages

Other important messages are provided throughout this manual to help prevent damage to your submersible pump, other property, or the surrounding environment.

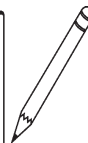
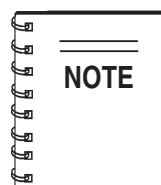

This submersible pump, other property, or the surrounding environment could be damaged if you do not follow instructions.

ST2037, 47, 47B, 38P, 40T SUB. PUMP — RULES FOR SAFE OPERATION

CAUTION

Failure to follow instructions in this manual may lead to serious injury or even death! This equipment is to be operated by trained and qualified personnel only! This equipment is for industrial use only.

The following safety guidelines should always be used when operating the ST2037, ST2047, ST2047B, ST2038P, and ST2040T Submersible Pump:

GENERAL SAFETY

- **DO NOT** operate or service this equipment before reading this entire manual.



- This equipment should not be operated by persons under 18 years of age.
- **NEVER** operate this equipment without proper protective clothing, shatterproof glasses, steel-toed boots and other protective devices required by the job.



- **NEVER** operate this equipment when not feeling well due to fatigue, illness or taking medicine.



- **NEVER** operate this equipment under the influence of drugs or alcohol.



- **NEVER** use accessories or attachments, which are not recommended by Multiquip for this equipment. Damage to the equipment and/or injury to user may result.
- Manufacture does not assume responsibility for any accident due to equipment modifications.
- Whenever necessary, replace nameplate, operation and safety decals when they become difficult read.
- **ALWAYS** check the machine for loosened threads or bolts before starting.
- **NEVER** operate the submersible pump in an explosive atmosphere or near combustible materials. An explosion or fire could result causing severe **bodily harm or even death**.
- **ALWAYS** make sure submersible pump is grounded.

- **NEVER** use gas piping as an electrical ground.
- **DO NOT** place hands or fingers inside pump when pump is running.
- **ALWAYS** make certain that the voltage supplied to the pump is correct. Always read the pump's nameplate to determine what the power requirements are. The ST2037, ST2047, ST2038P, and ST2040T submersible pumps require 115 VAC, 60 Hz (single-phase) for normal operation.
- **DO NOT** restrict the flow of the discharge hose as it may cause overheating.
- Be careful of discharge whipping under pressure.
- Make sure pump installation is accordance with national and local electrical codes.
- **ALWAYS** have a qualified electrician perform the pump wiring installation.
- **ALWAYS** mount the control box in a vertical position protected from the elements.
- **NEVER** handle pump's AC power cord with **wet hands**.
- **NEVER** let an extension cord or plug connection **lay in water**.
- **NEVER stand in water** while AC power cord is connected to a power source.
- **NEVER** use a pump with a defective, frayed power cord. Check the power cord on the pump for cuts in the insulation.
- **NEVER** use a extension cord that is frayed or damaged where the insulation has been cut.
- **ALWAYS** make certain that proper extension cord has been selected for the job See Table 4.
- **NEVER** attempt to use the power cord as a lifting or lowering device for the submersible pump.
- When raising or lowering of the submersible pump is required, always attach an adequate rope or lifting device to the correct lifting point (handle) on the pump.
- **ALWAYS** place the pump in an upright position on a platform before using. The platform will prevent the pump from burrowing itself on soft sand or mud.
- **NEVER** operate pump on its side.
- **DO NOT** allow the pump to freeze in water.
- **NEVER** leave an open pump chamber unattended.
- The electrical voltage required to operate the pump can cause severe injury or even death through physical contact with live circuits. **ALWAYS** disconnect the electrical power from the pump before performing maintenance on the pump.
- **ALWAYS** make sure that electrical circuits are properly **grounded** per the **National Electrical Code** (NEC) and

ST2037, 47, 47B, 38P, 40T SUB. PUMP — RULES FOR SAFE OPERATION

local codes before operating pump. **Severe injury or death** by **electrocution** can result from operating an **ungrounded** pump.

! WARNING- Risk of Electric Shock

This pump is supplied with a grounding conductor and grounding-type attachment plug. To reduce the risk of electric shock, be certain that it is connected only to a properly grounded, grounding-type receptacle.

- **NEVER** use this pump to remove water from a swimming pool when **people are in the water**.
- **ALWAYS** be sure the operator is familiar with proper safety precautions and operations techniques before using submersible pump.
- **ALWAYS** check pump oil level only when pump is cool. Expansion due to heat may cause hot! oil to spray from the oil plug when the oil plug is removed.
- **DO NOT** attempt to thaw-out a frozen pump by using a torch or other source of flame. Application of heat in this manner may heat the oil in the seal cavity above the critical point, causing pump damage.
- **DO NOT** pump water greater than 104 degrees Fahrenheit. Also **DO NOT** pump liquids containing acid or alkali.
- **ALWAYS** check strainer before pumping. Make sure strainer is not clogged. Remove any large objects, dirt or debris from the strainer to prevent clogging.
- **ALWAYS** use a large basket strainer when pumping water that contain large debris.
- **ALWAYS** flush pump after use when pumping water concentrated with heavy debris. **Flush with clean fresh water**. It is very important to always flush the pump before turning it off to prevent clogging.
- **ALWAYS** store equipment properly when it is not being used. Equipment should be stored in a clean, dry location out of the reach of children.
- **ALWAYS** read, understand, and follow procedures in Operator's Manual before attempting to operate equipment.

Maintenance Safety

- **NEVER** lubricate components or attempt service on a running machine.
- **ALWAYS** allow the machine a proper amount of time to cool before servicing.
- Keep the machinery in proper running condition.
- Fix damage to the machine immediately and always replace broken parts.

Emergencies

- **ALWAYS** know the location of the nearest **fire extinguisher**.



- **ALWAYS** know the location of the nearest and **first aid kit**.



- In emergencies **always** know the location of the nearest phone or **keep a phone on the job site**. Also know the phone numbers of the nearest **ambulance, doctor** and **fire department**. This information will be invaluable in the case of an emergency.

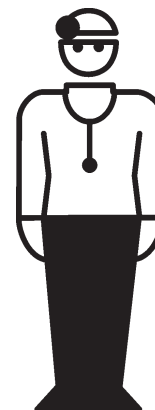
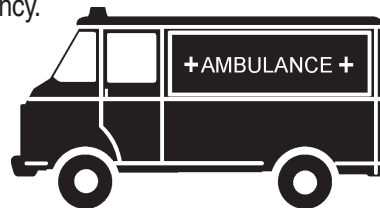

ST2037, 47, 47B, 38P, 40T SUB. PUMP — DIMENSIONS

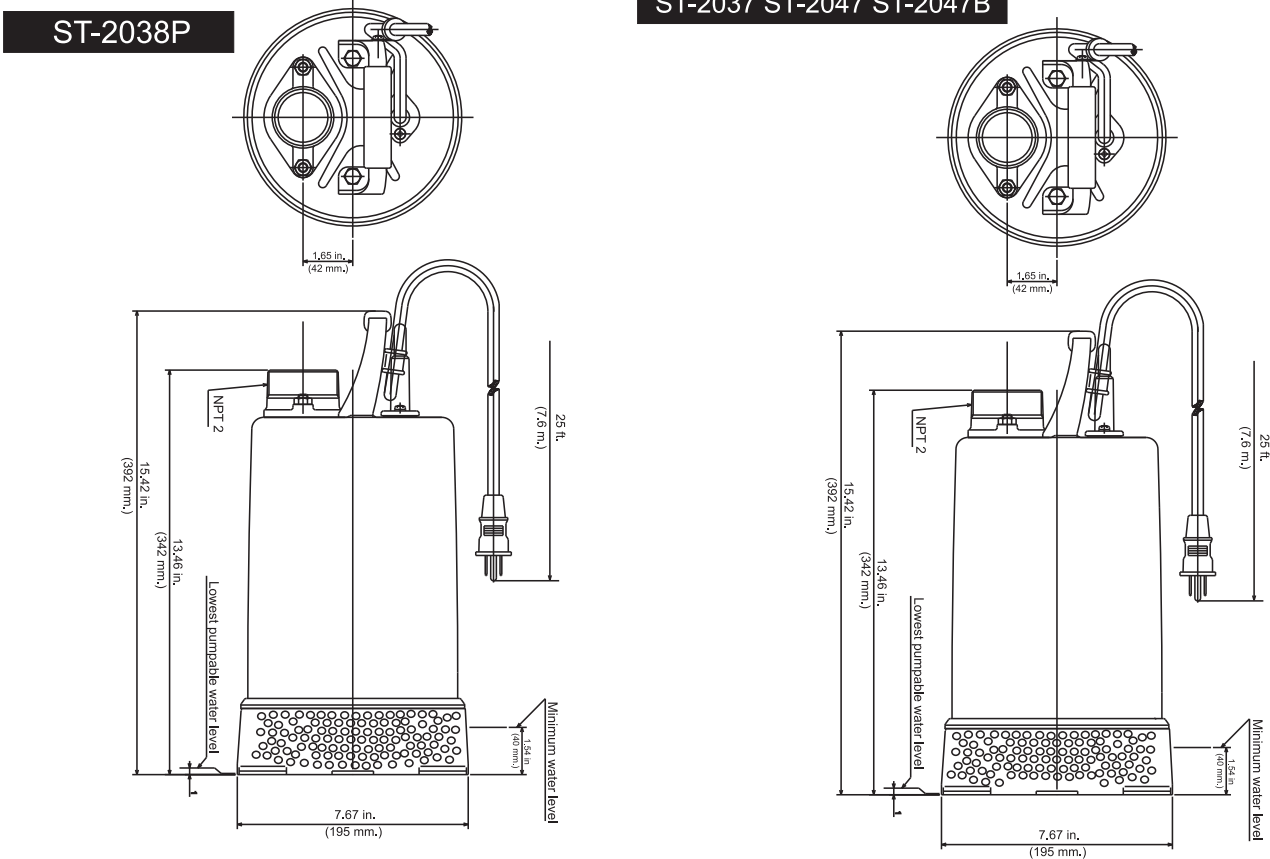
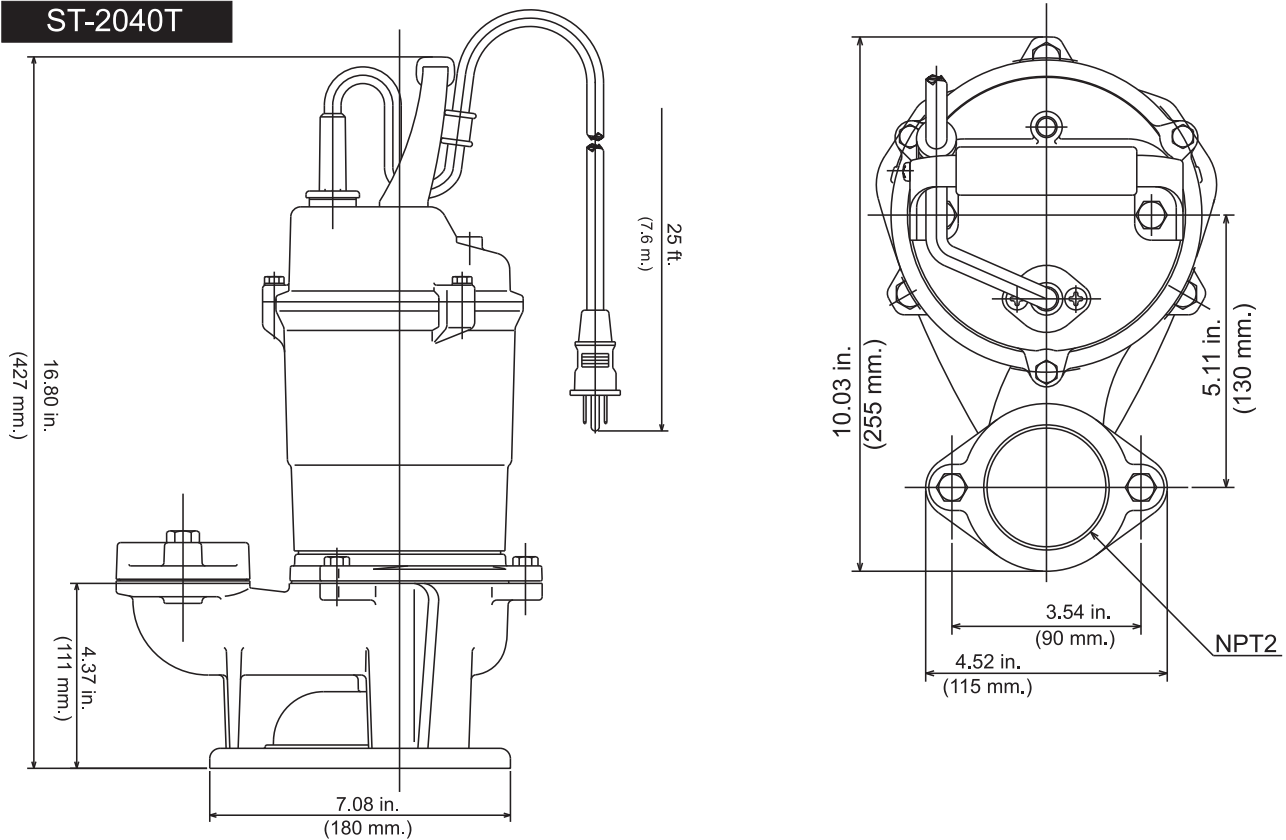

Figure 1. Submersible Pump Dimensions

ST2037, 47, 47B, 38P, 40T SUB. PUMP — SPECIFICATIONS

TABLE 1. SPECIFICATIONS

Model	ST-2037	ST-2047 / ST-2047B	ST-2038P	ST-2040T
Type	Centrifugal Submersible Pump	Centrifugal Submersible Pump	Centrifugal Submersible Pump	Submersible Trash Pump
Impeller	Nitorile Rubber over Steel	Nitorile Rubber over Steel	Nitorile Rubber over Steel	Nitorile Rubber over Steel
Suction & Discharge Size	2.00 in. (50 mm)	2.00 in. (50 mm)	2.00 in. (50 mm)	2.00 in. (50 mm)
Maximum Pumping Capacity	73 gallons/minute (272 liters/minute)	87 gallons/minute (322 liters/minute)	60 gallons/minute (227 liters/minute)	79 gallons/minute (299 liters/minute)
Max Head	37 ft. (10.6 meters)	47 ft (13.9 meters)	38 ft (11 meters)	40 ft. (11.4 meters)
Power	1 HP (0.75 kw)	1 HP (0.75 kw)	1 HP (0.75 kw)	1 HP (0.75 kw)
Voltage Phase	1Ø 115V	1Ø 115V / 1Ø 230V	1Ø 115V	1Ø 120V
Starting Amps	25	25 / 12.5	25	25
Running Amps	6.9	9.8 / 4.9	6.8	6.8
Control Box Required	See Note 3	See Note 3	See Note 3	See Note 3
Thermal Overload Protection	YES	YES	YES	YES
Rotation	CCW (Note 1)	CCW (Note 1)	CCW (Note 1)	CCW (Note 1)
Mechanical Seal Oil Capacity	120 cc. (Note 2)	120 cc. (Note 2)	120 cc. (Note 2)	133 cc. (Note 2)
Check Frequency	Monthly (300 hrs.)	Monthly (300 hrs.)	Monthly (300 hrs.)	Monthly (300 hrs.)
RPM (Speed)	3390 +/- 30	3250 +/- 30	3400 +/- 30	3390 +/- 30
Power Cable Length	25 FT. (7.6 m.)	50 FT. (15.2 m.)	25 FT. (7.6 m.)	25 FT. (7.6 m.)
Dry Net weight	31 lb (14 kg)	33 lb (15 kg)	31 lb (14 kg)	34 lb (15.4 kg)

- Motor Rotation** – Upon start-up, the pump "**kicks**" in the opposite direction of motor rotation. The correct rotation is counterclockwise (CCW) as viewed from the impeller end of the pump.
- Mechanical Seal Oil** – Use a good grade 10 weight non-detergent hydraulic oil (i.e. Shell Turbo 32 or equivalent). Fill oil cavity 75% to 85% full (allow air space for expansion).
- Control Box** - Control box (Table 2) may be required for certain pumping applications.

Table 2. Control Box Specifications

Model No.	VoltageType	UL/CSA Listed	Thermal Overload Protection	Float Switch Capability
CB3	115 VAC, 60 Hz Single-Phase	YES	YES	YES

ST2037, 47, 47B, 38P, 40T SUB. PUMP — GENERAL INFORMATION

Introduction

The Multiquip Model ST2037, ST2047, ST2047B, ST2038P, and ST2040T submersible pumps are designed to pump water and is used for the draining (de-watering) of swimming pools, well casings construction sites, cofferdams, manholes, transformer vaults and excavations.

A Nitorile rubber over steel impeller is attached to the output shaft of a 1HP electric motor which provides adequate power for general purpose pumping. This submersible pump is supplied complete with an electric power cable, and a discharge port located at the top of the pump which accepts a 2-inch hose.

This pump is ideal for portability because of its light weight and carrying handle. For reliability and long life, a mechanical seal provides shaft sealing, with an oil chamber separating the pump section from the motor.

The pump when in use, should be installed as free standing (upright position) on its strainer base. A 2-inch discharge hose (not supplied) should be connected to the discharge port located on top of the pump. The discharge hose should be adequately supported to avoid stress on the pump.

For maximum water flow, the discharge hose should be kept as short as possible, and with minimum elevation above the pump. Remember as the length and/or height of the discharge hose is increased, the flow of water will be reduced. Also any reduction in the hose size, and any fittings such as valves or outlet nozzles, will restrict the water flow.

To avoid back-siphonage when the pump is switched off, ensure that the end of the discharge hose is installed above the water level at the final discharge point.

When the pump is switched off, the water remaining in the hose will run back through the pump. This can be avoided by placing a non-return valve in the hose nearest the pump.

NEVER use this submersible pump to pump flammable liquids or operate in a explosive or flammable environment.

Avoid using this pump in conditions where mud, grit, silt or other debris are present. These conditions could cause blockage and cause excessive pump wear.

DO NOT install the pump directly into an area where there is a heavy buildup of mud, grit, silt or debris. If this condition is present, install the pump on a platform before operating.

This pump must always be positioned on a platform in an upright position. **NEVER** operate the pump by a suspended rope. To prevent large solids from entering the pump, install a wire mesh screen or similar barrier around the pump.

If the pump was used to pump water containing mud, silt, use clean water to flush out the pump after each use.

DO NOT allow the pump to run dry, as this will damage the pump. During maintenance, dry running is permissible but only for a few seconds.



NEVER lift the pump by its electrical power cord. **ALWAYS** lift the pump by its carrying handle or attach a rope to the carrying handle.

A pump fully submerged pump in liquid will not freeze, unless the liquid freezes. **DO NOT** allow a partially submerged pump to freeze. The expansion of water freezing in the volute may crack the pump, causing expensive repairs. If there is any danger of the pump being subjected to freezing temperatures, Lift the pump from water and allow it to drain thoroughly.



If the pump jams or the pump rotor locks for any reason, disconnect the pump from the power source immediately. Allowing the pump motor to cycle **ON** and **OFF** under an overload condition can burn out the motor.

When replacement of nuts and bolts is required, use only recommended parts as referenced in the parts section of this manual. This pump uses **metric** threads. **DO NOT** use English measurement threads.

Control Box Installation Warnings

**DANGER**

When installing the CB3 control box, the possibility exists of **electrical shock**, **electrocution** and possibly **death!** **NEVER** have untrained personnel perform the installation. **ALWAYS** have qualified service personnel (licensed electrician) perform the installation.

**WARNING**

Explosion or Fire Hazard exists if this pump is used with **flammable liquids**. **DO NOT** use this pump with **flammable liquids**. **DO NOT** install this pump in hazardous locations as defined by the National Electrical Code, ANSI/NFPA 70.

Failure to follow the above referenced precautions could result in serious injury or death! Replace pump cord immediately if cord becomes damaged or severed. This pump must be installed in accordance with National Electric Code ANSI/NFPA 70 so as to prevent moisture from entering or accumulating with the boxes, conduit bodies fittings, float housing or cable.

ST2037, 47, 47B, 38P, 40T SUB. PUMP — COMPONENTS

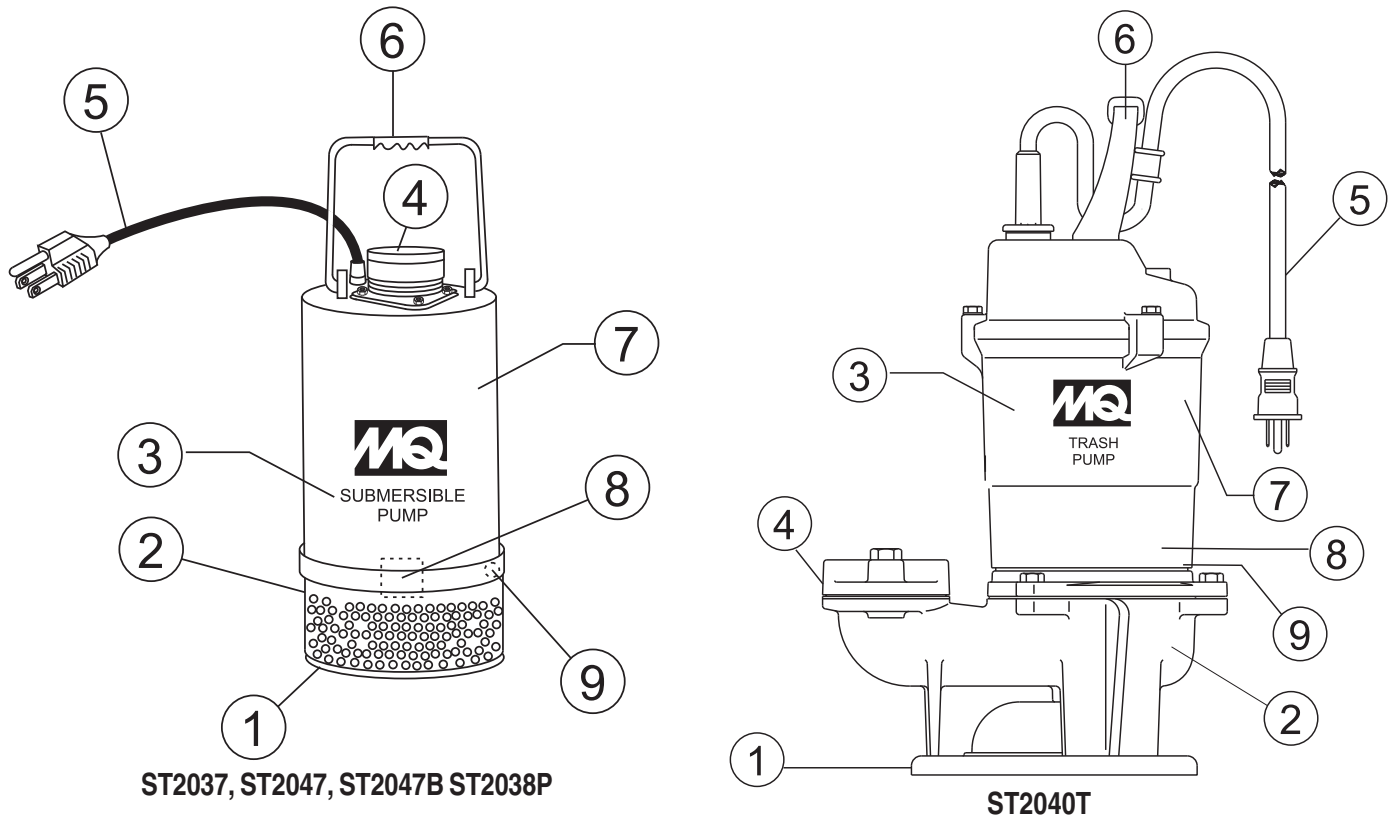

Figure 2. Submersible Pump Components

Figure 2 shows the location of the basic components, for the ST2037, ST2047, ST2047B, ST2038P, and ST2040T submersible pumps. Listed below is a brief explanation of each component.

1. **Strainer Base** – This strainer base is made of electrocating steel which is resistant to hardware corrosion. **DO NOT** pump large objects or debris with this pump. This pump is for pumping water only. For de-watering purposes, always place the strainer base on a platform.
2. **Volute/Impeller** – Impellers are constructed of Nitorile Rubber to minimize wear and prolong service life.
3. **Electric Motor** – These submersible pumps utilize a 60 Hz, single-phase, 115 VAC, 1 HP electric motor. Consult with a **licensed electrician** before connecting motor to a power source. Observe all city and local safety codes.
4. **Discharge Port** – Connect a 2-inch hose to this port. Remember to adequately support the discharge hose to avoid stress on the pump.
5. **AC Power Cable** – This unit is supplied with a 25 ft. (7.6 meters) or 50 ft. (15.2 meters) AC power cable. Always check the cable for signs of wear. **NEVER!** use a defective power cable. Replace the cable immediately if the cable is worn or defective.
6. **Carrying Handle** – Always carry the submersible pump by its handle. **NEVER!** carry the pump by its power cord. Carrying or lifting the pump by the power cord, will cause undue stress on the cord, and ultimately the cord will become dislodged from the pump.
7. **Thermal Overload Protection** – This pump is equipped with a thermal overload protection device that will shut down the motor in the event of high operating temperatures. The motor will automatically restart once the temperature returns to an acceptable operating temperature.
8. **Mechanical Seal Oil** – This oil filled seal provides lubrication when running the pump dry. **NEVER!** run the pump dry. Running the pump dry will cause severe damage to the pump.
9. **Mechanical Seal Oil Plug** – Remove this plug to check and add hydraulic oil (Shell 32 or equivalent) to the oil cavity. This oil protects the mechanical seal. Oil cavity should be full enough to cover seal spring.

ST2037, 47, 47B, 38P, 40T SUB. PUMP — FLOAT SWITCHES

Float Switch Theory

Mercury monitoring is a mercury-switch actuated, liquid level control that has proven to be more economical and longer lasting than other types of liquid-level control systems, easily replacing and improving upon diaphragm switches, air bubble systems and electromechanical switches most often relied upon in the past.

How It Works

There is a tilt-sensitive mercury switch hermetically sealed within each float. As the liquid level (water) rises or falls, the float changes its angle until the mercury switch makes (close, Figure 4) or breaks (open Figure 5) the circuit. Maximum pumping range is 120 degrees. See Figure 3 below.

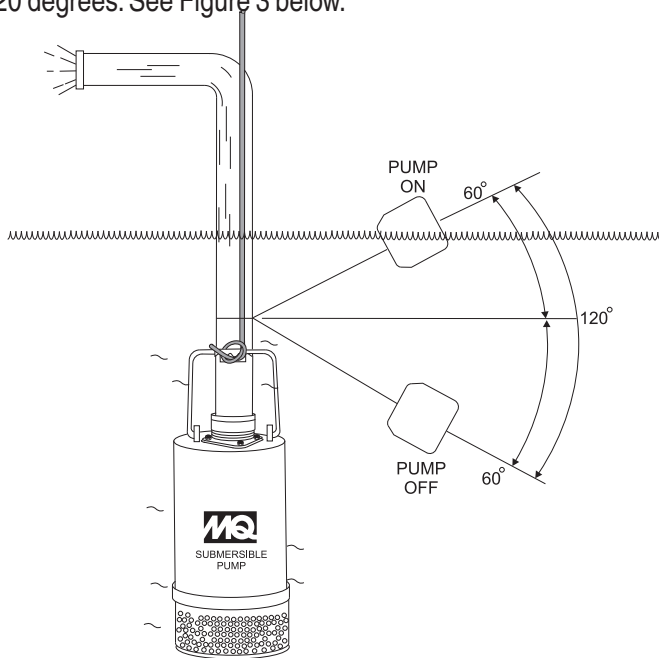

Figure 3. Pumping Range (Float Switch)

Pumping Range

The pumping range of the pump is determined by the float switch tether cord. Use Table 3 as guide line to determine your required pumping range. Pumping ranges are based on **non-turbulent** conditions. Range may vary due to water temperature and cord shape. Please note as the tether length increases, so does the variance of the pumping range.

Table 3. Pumping Range

Tether Length	2 in. 5.08 cm.	4 in. 10.16 cm.	6 in. 15.24 cm.	8 in. 20.32 cm.	10 in. 25.4 cm.	12 in. 30.48 cm.	14 in. 35.56 cm.	16 in. 40.64 cm.
Pumping Range	6 in. 15.24 cm.	10 in. 25.4 cm.	14 in. 35.56 cm.	18 in. 45.72 cm.	22 in. 55.88 cm.	27 in. 68.58 cm.	31 in. 78.74 cm.	35 in. 88.9 cm.

Design Features

Constructed of rigid, durable ABS polymer ultrasonically welded. The all-steel mercury switch is held by positioning pins. Interior is filled with cell foam.

- Suitable for most liquid environments.
- Hermetically sealed.
- Thick-walled non-corrosive PVC plastic enclosure.
- Pressure tested to 60 ft. (18.2 meters).
- Mercury switch reliability, proven to 500,000 cycles.
- Standard SJO, 16-gauge, 2 conductor cord (20 ft./6.09 m).

Pump Down / ON POSITION

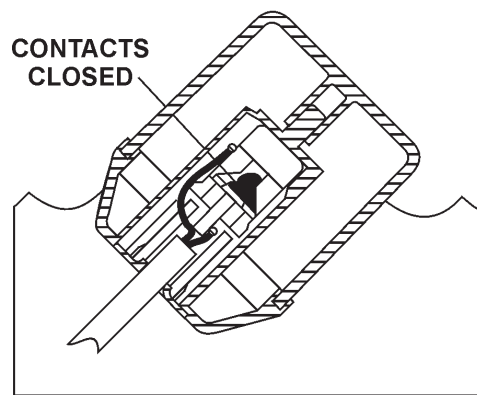

Figure 4. Float Switch (Closed)

Pump Down / OFF POSITION

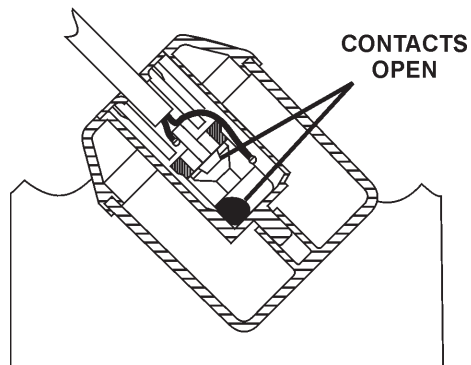

Figure 5. Float Switch (Open)

ST2037, 47, 47B, 38P, 40T SUB. PUMP — FLOAT SWITCH (PIGGY-BACK)

Float Switch

Single or **dual** control float switches (Figure 6) can be used for the unattended operation of the submersible pump. When using the **piggy-back power configuration** (plug), the pumps **DO NOT** require the use of a control box. In this configuration (piggy-back), the SW-1 (single float switch) or SW-2 (dual float switch) are required. The illustration below is an example of a single float switch application.

Mounting The Float Switch

1. Determine the required **cord tether length** as shown in Figure 6 and Table 3.
2. Place the cord into the clamp as shown in Figure 6.
3. Secure the clamp to the discharge hose as shown in Figure 5. **DO NOT** install cord under hose clamp.
4. Using a screwdriver, tighten the hose clamp. **DO NOT** over-tighten. Make sure the float cord is not allowed to touch the excess hose clamp band during operation.

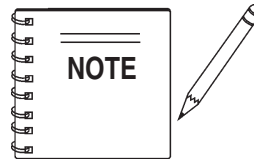

Figure 6 shows a **single float** switch application. For dual float switch capability use a **Model SW-2** mercury type float switch .

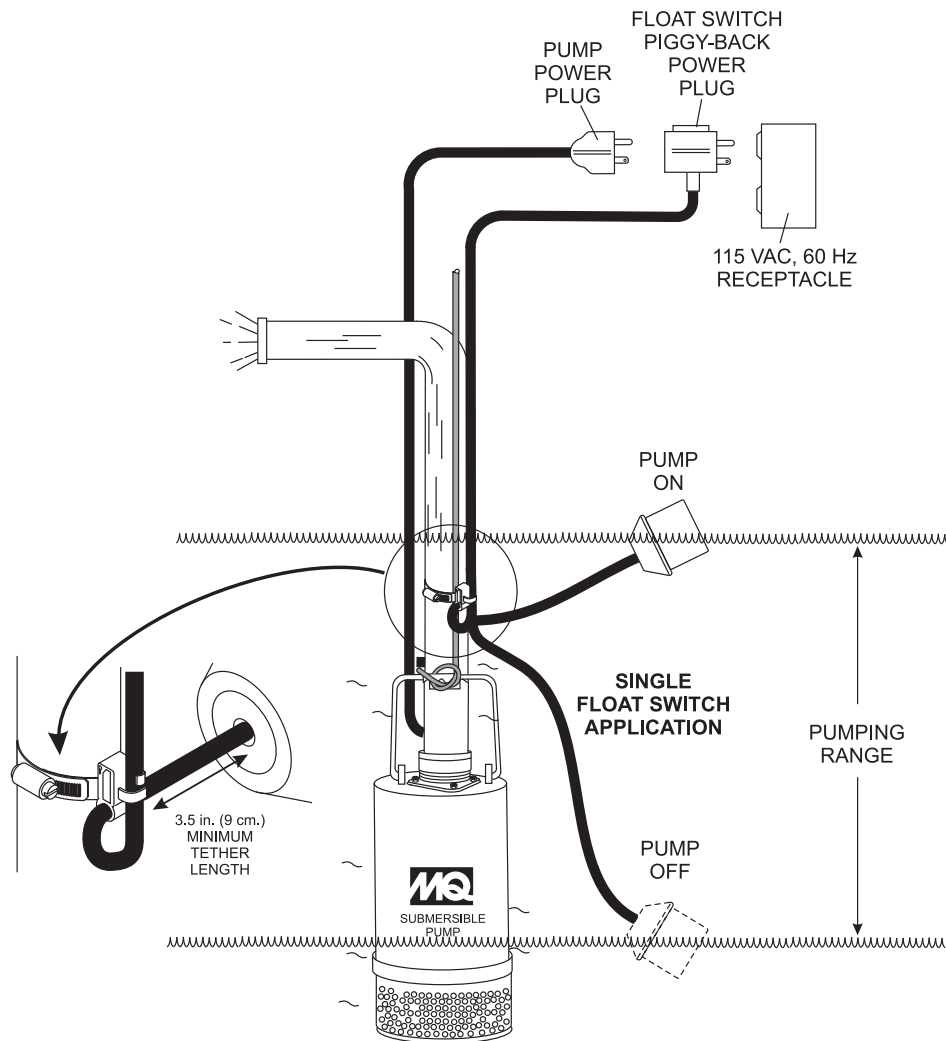

Figure 6. Single Float Switch Application Diagram

ST2037, 47, 47B, 38P, 40T SUB. PUMP — OPERATION

Hose Connections

1. Connect a 2-inch hose to the discharge port on the pump as shown in Figure 8. Make sure that the hose is attached correctly to the discharge port.

Pump Power Connections (Piggy-Back Cord Only)

1. Make sure the circuit breaker supplying power to the pump is in the **OFF** position.
2. Connect the float switch or switches to the AC power receptacle as shown in Figure 6.

Attaching Lifting Rope

1. Attach a suitable lifting cable (rope) to the carrying handle (Figure 8) on the pump and lower the pump into place. For applications where there is an excessive amount of mud, grit or silt, the use of a support platform is desirable. When pumping water from swimming pool type applications where there is little or no debris, the support platform is not required

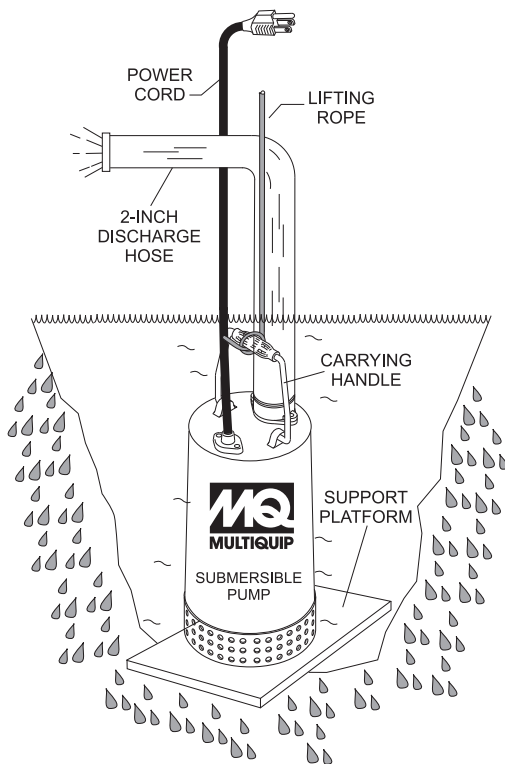

Figure 8. Submersible Pump Upright Position (Correct)

2. Make sure the pump is always placed in an upright position, not tilted (Figure 9). Never position the pump directly on a soft, loose bottom. Remember to attain maximum pumping capacity and prevent excessive wear, position the pump so it will not burrow itself into sand or clay.

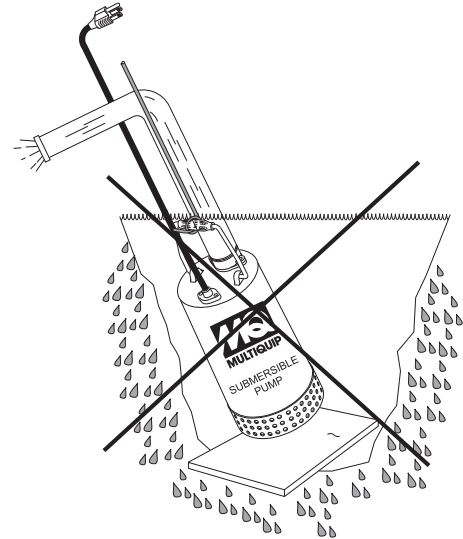

Figure 9. Submersible Pump Upright Position (Incorrect)

3. If all of the pump's electrical requirements have been met, place the **circuit breaker** or power **ON/OFF** switch in the **ON** position.
4. Wait a few seconds and water should begin to flow from the discharge hose.
5. If water is not flowing from the discharge hose or not flowing freely after a few minutes, remove the power from the pump and check the system for leaks.
6. To stop the pump from pumping, place the **circuit breaker** or **ON/OFF** switch in the **OFF** position.

! DANGER

NEVER! grab or touch a live power cord (Figure 10). **DO NOT** stand in water when connecting the pump's power cord into a voltage source. The possibility exists of **electrical shock, electrocution** and possibly **death!**

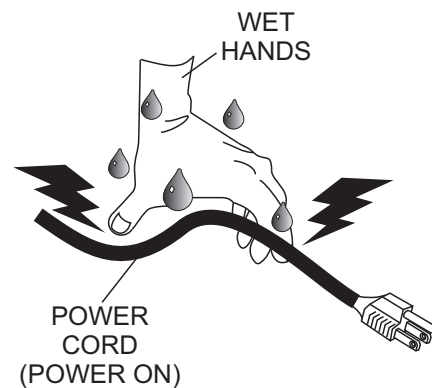

Figure 10. Power Cord (Wet Hands)

ST2037, 47, 47B, 38P, 40T SUB. PUMP— CONTROL BOX INSTALLATION

DANGER

The ST2037, ST2047, ST2047B, ST2038P, and ST2040T submersible pumps are also designed to work with a control box (**Model CB3**). This control box contains the necessary electronics (float switch connections) to operate the pump. Remember this control box contains hazardous voltages. Disconnect all sources of power before installing or servicing. There exists the possibility of electrocution, electric shock or burn, which can cause severe bodily harm or even **death!**



CAUTION

This control box should only be installed or serviced by a **licensed electrician or qualified personnel.**

Control Box Mounting

Mount the control box in an **upright vertical position**. Make sure the control box is securely fastened to a flat surface, that is free of dust, dirt, moisture or any elements that may contaminate or erode the electronic components of the control box.

Single-Phase Power Installation (Input)

All submersible pumps referred to in this manual require 115 V, 60 Hz., single-phase power for **normal operation**.

If you cannot determine what your pump's power requirements are, look at the vendor supplied identification name tag attached to the pump or please contact Multiquip's Service/Technical Assistance department.

CAUTION

Applying incorrect power (**voltage phasing**) to the submersible pump can cause severe damage to the pump. Please make sure that the correct voltage and phase are transferred to the pump at all times.

Power Cord Requirements

When routing the 115 VAC, 60 Hz., single phase power via a power cord to the control box, **ALWAYS** use the correct wire size. Please reference Table 4 below (Cord Length/Wire Size) to determine the correct wire size. Incorrect wire size can adversely affect the performance of the pump.

TABLE 4. CORD LENGTH AND WIRE SIZE

AMPS	50 FT.	100 FT.	150 FT.
6	16 AWG	16 AWG	14 AWG
8	16 AWG	14 AWG	12 AWG
10	16 AWG	14 AWG	12 AWG
12	14 AWG	14 AWG	12 AWG
14	14 AWG	12 AWG	10 AWG
16	12 AWG	12 AWG	10 AWG

Connecting Dual float Switch (SW-1WOP) To Control Box

1. Remove the float switch input connector housing, then route the float switch wires through the cable gland on the control box. Attach the wires of the float switch to the terminal block as indicated by Table 5. and Figure 6.

TABLE 5. FLOAT SWITCH CONNECTIONS

FLOAT SWITCH	TERMINAL BLOCK NUMBER
START	TERMINAL 1 (BLACK) TERMINAL 2 (WHITE)
STOP	TERMINAL 7 (WHITE) TERMINAL 8 (BLACK)

2. Tighten the connector housing to ensure a tight fit between the cord and the connector body. This will prevent the cable from pulling out of the terminal block and also prevent moisture from entering the control box.
3. Determine the length of the float switch wires, then secure float switch wires to pump discharge hose. See Figures 3 and 6 and Table 3 to determine the pumping range.

ST2037, 47, 47B, 38P, 40T SUB. PUMP— CONTROL BOX INSTALLATION

Connecting AC Power to the Control Box

1. The AC power cord (input) should have three wires. Each wire is color coded. The colors are **WHITE, BLACK** and **GREEN**.
2. Remove the AC input connector housing from the control box, then route the power cord through the cable gland on the control box.
3. Connect the AC power cord to the contactor as shown in Figure 7 and Table 6.

CABLE WIRE COLOR	CONTACTOR
BLACK	L1
WHITE	L2
GREEN	GROUND

3. Tighten the connector housing to ensure a tight fit between the power cord and the connector body. This will prevent the cable from pulling out of the terminal block and also prevent moisture from entering the control box.

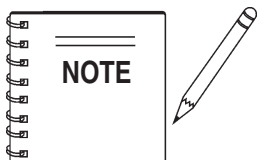

It is recommended that the power being supplied to the control box **ALWAYS** be connected to a **circuit breaker** or a **quick disconnect** switch. This safety feature allows for quick removal of power from the control box in the event of an emergency.

4. Connect the other end of the AC power cord to the voltage source. Remember to provide a means of disconnecting the power from the control box (circuit breaker or quick disconnect switch). Also make sure to provide a good earth ground to the control box.

Connecting AC Power to the Pump

1. AC power is transferred to the pump via a contactor. The coil of the contactor is energized or de-energized by the opening and closing of the float switch contacts. The power cord should have three wires. Each wire is color coded. The colors are **WHITE, BLACK** and **GREEN**.

2. Remove the pump AC input connector housing from the control box, then route the power cord through the cable gland on the control box.
3. Connect the pump power cord to the contactor as shown in Figure 7 and Table 7.

CABLE WIRE COLOR	CONTACTOR
BLACK	T1
WHITE	T2
GREEN	GROUND

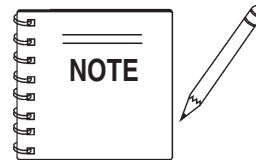

Electrical connections to the power source should only be performed by a **licensed electrician** or **qualified personnel**.

Turning On The Pump

1. If all of the pump's electrical requirements have been met, place the **circuit breaker** or power **ON/OFF** switch in the **ON** position.
2. The CB3 control box has an **operation switch** located on the front cover. This switch has 3 positions, **AUTO**, **MANUAL** and **OFF**. The **AUTO** position allows the pump to run in an un-attended mode. The **MANUAL** position will let the pump run without the float switches controlling the pump. When in the manual mode be careful not to let the pump run dry. Severe damage to the pump may occur if it is allowed to run dry. **NEVER** let the pump **run dry**.
3. Place the operation switch in the **AUTO** position. The AC power indicator lamp should be lit (**ON**).
4. Wait a few seconds and water should begin to flow from the discharge hose.
5. If water is not flowing from the discharge hose or not flowing freely after a few minutes, remove the power from the pump and check the system for leaks.
6. To stop the pump from pumping, place the operation switch in the **OFF** position.

ST2037, 47, 47B, 38P, 40T SUB. PUMP — CLEAN-UP AND MAINTENANCE

Pump Shut-Down/Clean-up

1. Remove the power from the pump by turning off the circuit breaker or switch that provides power to the pump. Remember to make sure that hands are dry (not wet), and feet are not standing in water when removing disconnecting power from the pump.
2. Using the lifting rope, lift the pump up from its current position. Remove the discharge hose from the discharge port on the pump.
3. Remove all power cables and float switches from the control box. Place cables and float switches in a suitable container where they will not get damaged.
4. If the pump was used to pump mud, grit or silt, flush vigorously with clean water.
5. Remove the pump from the water. Wipe off any mud or debris that might have attached itself to the pump.
6. Store pump in a clean dry place away from dirt and debris.

LUBRICATION

To check the oil level of the mechanical seal perform the following:

DISASSEMBLY

Refer to Figure 11 for location of parts to be removed.

For Model ST2040T:

1. Position pump upside down.
2. Remove casing.
3. Remove the pump impeller.
4. Remove the oil plug and packing.

For Model ST2037, ST2047, ST2047B and ST2038P:

1. Position pump upside down.
2. Remove strainer.
3. Remove casing.
4. Remove the pump impeller.
5. Remove the liner.
6. Remove the oil plug and packing.

OIL CHECK

1. Check pump oil at oil cavity plug (Figure 11). Check every 300 hours and change hydraulic oil every 6 months (1,000 hours) or as needed.
2. While checking the hydraulic oil level, also check the condition of the hydraulic oil in the seal cavity. Discolored milky oil indicates a failure of the water seal. If this occurs, replace water seal.
3. If oil level is low fill with SAE 10 weight non-detergent hydraulic oil (i.e. Shell Turbo 32 or equivalent). Fill oil cavity 75% to 85% full (allow air space for expansion). See Table 1 for mechanical seal oil capacity.

IMPELLER

1. If impeller is defective or badly worn, replace impeller immediately.

ST2037, 47, 47B, 38P, 40T SUB. PUMP — MAINTENANCE

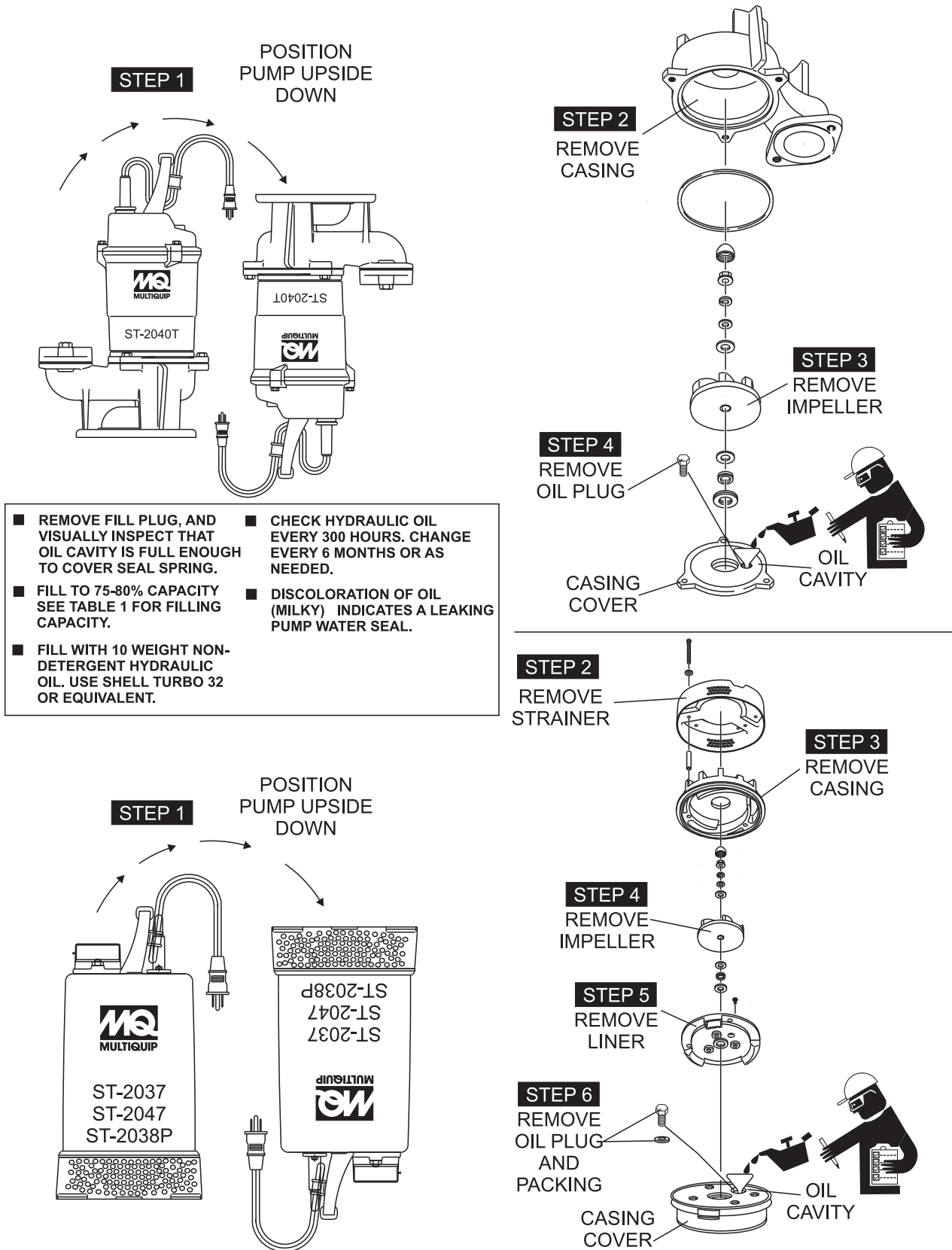

Figure 11. Checking Hydraulic Oil

ST2037, 47, 47B, 38P, 40T SUB. PUMP — TROUBLESHOOTING

Practically all breakdowns can be prevented by proper handling and maintenance inspections, but in the event of a breakdown, use Table 8 (Pump Troubleshooting) as a basic guideline for troubleshooting the pump. If the problem cannot be remedied, contact Multiquip's service department.

TABLE 8. PUMP TROUBLESHOOTING

SYMPTOM	POSSIBLE PROBLEM	SOLUTION
Pump Fails To Start	Incorrect voltage/amps?	Check that proper voltage (115 VAC, 60 Hz, single-phase) is being supplied to the pump. Also check that there is an adequate amount of current (amps) to run the pump. Check power source circuit breaker.
	Check electrical connections?	If using float switches check wiring, inspect power cord.
	Blown power fuse?	Replace fuse, check cause of blown fuse.
	Impeller locked?	Disconnect power cord and check for clogging. Unclog pump. Check overload protection device.
	Wet motor windings?	Use multimeter to check motor insulation. Insulation resistance must be approximately 15 megaohms. If resistance is low, disassemble pump motor and bake windings to dry them.
	Defective motor and pump bearings?	Check for excessive bearing wear, if worn replace bearings. Replace motor if defective.
Pump Fails to Deliver Full Output	Twisted or restricted discharge hose?	Lay hose flat un-kinked. Remove clog from hose line.
	Clogged pump strainer?	Clean strainer.
	Low voltage?	Use a voltmeter to check voltage while pump is energized. Voltage must be within $\pm 10\%$. Check power source (no load and load). If an extension cord is used, make sure it has adequate current-carrying capacity for the required length. See Table 4.
	Impeller worn?	Replace impeller.
Water in Seal Oil	Defective water seal?	Replace water seal.
	Loose Oil Fill Plug?	Tighten securely.

ST2037, 47, 47B, 38P, 40T SUB. PUMP — PERFORMANCE CURVES

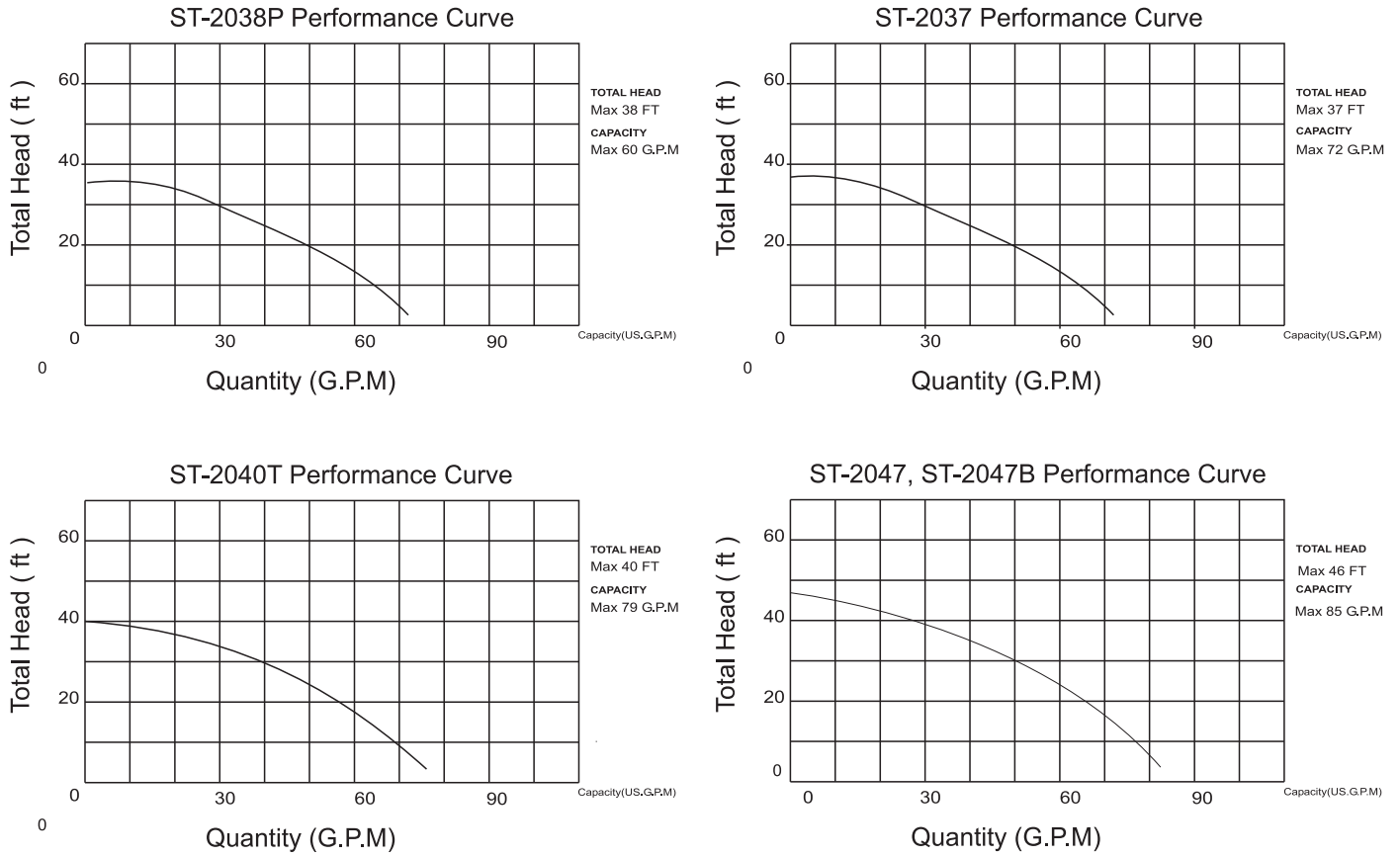

Figure 12. Pump Performance Curves

EXPLANATION OF CODE IN REMARKS COLUMN

The following section explains the different symbols and remarks used in the Parts section of this manual. Use the help numbers found on the back page of the manual if there are any questions.

NOTICE

The contents and part numbers listed in the parts section are subject to change **without notice**. Multiquip does not guarantee the availability of the parts listed.

SAMPLE PARTS LIST

NO.	PART NO.	PART NAME	QTY.	REMARKS
1	12345	BOLT.....	1	INCLUDES ITEMS W/%
2%		WASHER, 1/4 IN.....		NOT SOLD SEPARATELY
2%	12347	WASHER, 3/8 IN....	1	MQ-45T ONLY
3	12348	HOSE		A/R ...MAKE LOCALLY
4	12349	BEARING	1	S/N 2345B AND ABOVE

NO. Column

Unique Symbols — All items with same unique symbol

(@, #, +, %, or >) in the number column belong to the same assembly or kit, which is indicated by a note in the “Remarks” column.

Duplicate Item Numbers — Duplicate numbers indicate multiple part numbers, which are in effect for the same general item, such as different size saw blade guards in use or a part that has been updated on newer versions of the same machine.

NOTICE

When ordering a part that has more than one item number listed, check the remarks column for help in determining the proper part to order.

PART NO. Column

Numbers Used — Part numbers can be indicated by a number, a blank entry, or TBD.

TBD (To Be Determined) is generally used to show a part that has not been assigned a formal part number at the time of publication.

A blank entry generally indicates that the item is not sold separately or is not sold by Multiquip. Other entries will be clarified in the “Remarks” Column.

QTY. Column

Numbers Used — Item quantity can be indicated by a number, a blank entry, or A/R.

A/R (As Required) is generally used for hoses or other parts that are sold in bulk and cut to length.

A blank entry generally indicates that the item is not sold separately. Other entries will be clarified in the “Remarks” Column.

REMARKS Column

Some of the most common notes found in the “Remarks” Column are listed below. Other additional notes needed to describe the item can also be shown.

Assembly/Kit — All items on the parts list with the same unique symbol will be included when this item is purchased.

Indicated by:

“INCLUDES ITEMS W/(unique symbol)”

Serial Number Break — Used to list an effective serial number range where a particular part is used.

Indicated by:

“S/N XXXXX AND BELOW”

“S/N XXXX AND ABOVE”

“S/N XXXX TO S/N XXX”

Specific Model Number Use — Indicates that the part is used only with the specific model number or model number variant listed. It can also be used to show a part is NOT used on a specific model or model number variant.

Indicated by:

“XXXXX ONLY”

“NOT USED ON XXXX”

“Make/Obtain Locally” — Indicates that the part can be purchased at any hardware shop or made out of available items. Examples include battery cables, shims, and certain washers and nuts.

“Not Sold Separately” — Indicates that an item cannot be purchased as a separate item and is either part of an assembly/kit that can be purchased, or is not available for sale through Multiquip.

ST2037, 47, 47B, 38P, 40T SUB. PUMP — SUGGESTED SPARE PARTS

ST2037, ST2047, ST2047B ST2038P, ST2040T SUBMERSIBLE PUMP 1 TO 3 UNITS

Qty.	P/N	Description	Remarks
1	0201503UL120	AC CORD WITH GLAND	ST2037, ST2038P, ST2040T
1	0202010UL120	AC CORD WITH GLAND	ST2047
1	020S500UL060	MECHANICAL SEAL	
1	020S500UL074	PACKING	

ST2037, ST2047, ST2047B — ELECTRIC SUBMERSIBLE PUMP ASSY.

ST2037 AND ST2047 ELECTRIC SUBMERSIBLE PUMP ASSY.

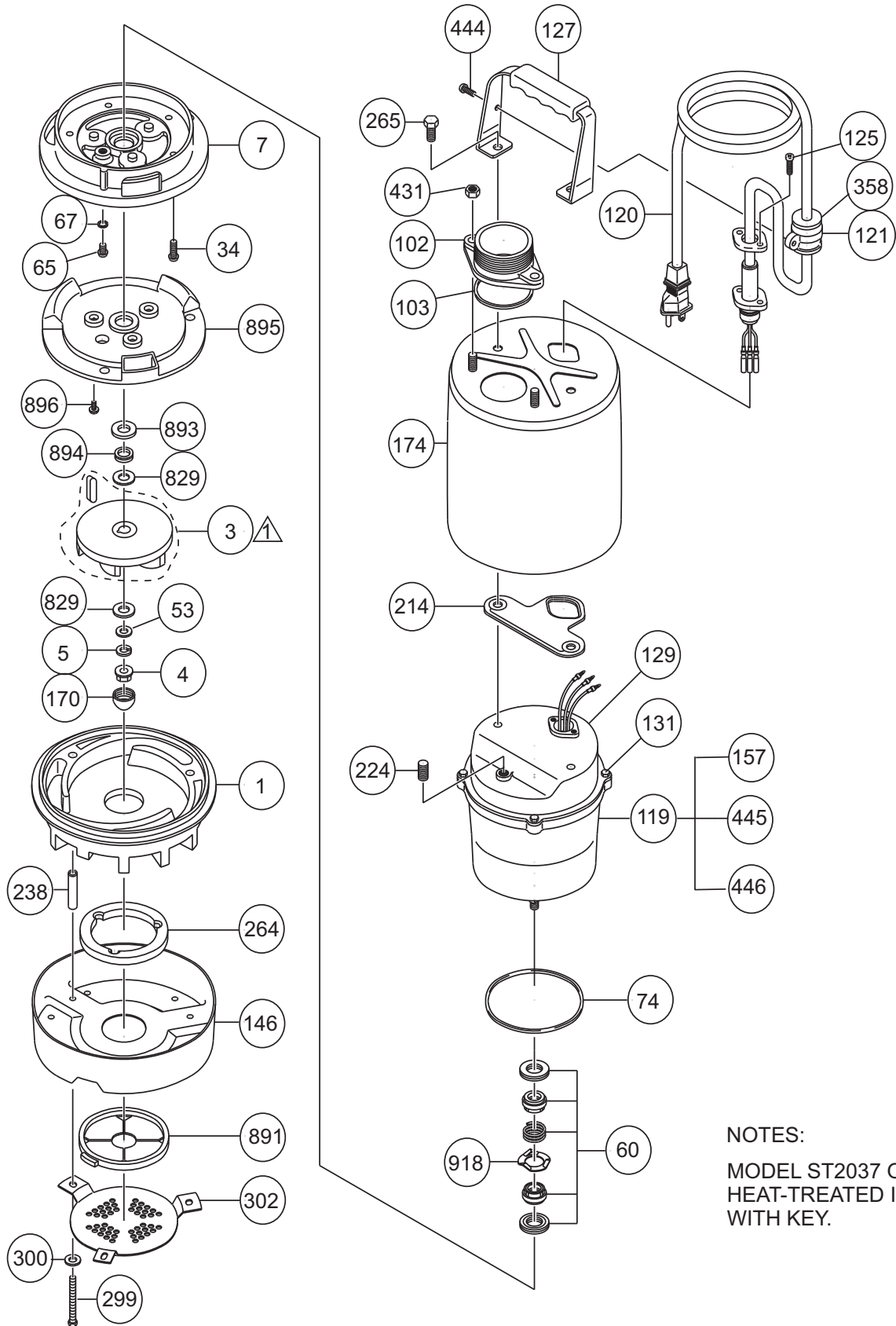

NOTES:
 MODEL ST2037 ONLY
 HEAT-TREATED IMPELLER
 WITH KEY.

ST2037, ST2047, ST2047B — ELECTRIC SUBMERSIBLE PUMP ASSY.

ST2037 AND ST2047 ELECTRIC SUBMERSIBLE PUMP ASSY.

<u>NO</u>	<u>PART NO</u>	<u>PART NAME</u>	<u>QTY.</u>	<u>REMARK</u>
1	020S500UL001	CASING	1	
3	020S500UL003	IMPELLER/W KEY	1	ST2037 ONLY
3	020S2047003	IMPELLER	1	ST2047 AND ST2047B ONLY
4	020S500UL004	IMPELLER NUT	1	
5	020S500UL005	SPRING WASHER	1	
7	020S500UL007	CASING COVER	1	
34	020S2037034	SCREW	3	
53	020S500UL053	WASHER	1	
60	020S500UL060	MECHANICAL SEAL	1	
65	020S500UL065	PLUG	1	
67	020S500UL067	PACKING	1	
74	020S500UL074	PACKING	1	
102	0202005A102	DISCHARGE PORT	1	
103	0201503A103	PACKING	1	
119	020S2047119	MOTOR	1	ST2037 AND ST2047 ONLY
119	020S2047B119	MOTOR	1	ST2047B ONLY
120	0201503UL120	AC CORD W/CORD GLAND	1	ST2037 ONLY
120	0202010UL120	AC CORD W/CORD GLAND	1	ST2047 ONLY
120	0202010B120	AC CORD W/CORD GLAND	1	ST2047B ONLY
121	0201503121	CORD CLAMP	1	
125	0201503125	SCREW	2	
127	020S500UL127	CARRYING HANDLE	1	
129	020S2047129	FRAME COVER	1	
131	020S2047131	BOLT	3	
146	020S500UL146	STRAINER	1	
157	020S2047157	PACKING	1	
170	020S500UL170	IMPELLER NUT CAP	1	
174	020S2037174	OUTER PIPE	1	
214	020S500UL214	PACKING	1	
224	0201503224	PLUG	1	
238	020S500UL238	SPACER	3	
265	020S500UL265	BOLT	2	
299	020S500UL299	BOLT	3	
300	020S500UL300	WASHER	3	
358	020S500UL358	AC CORD BAND	1	
431	020S500UL431	NUT	2	
444	020S500UL444	SCREW	1	
445	020S2047445	CAPACITOR	1	ST2037 AND ST2047 ONLY
445	020S2047B445	CAPACITATOR	1	ST2047B ONLY
446	020S2047446	THERMAL PROTECTOR	1	ST2037 AND ST2047 ONLY
446	020S2047B446	THERMAL PROTECTOR	1	ST2047B ONLY
829	020S500UL829	WASHER	2	
893	020S500UL893	SEAT	1	
894	020S500UL894	V-RING	1	
895	020S500UL895	LINER	1	
896	020S500UL896	SCREW	3	
918	020S500UL918	STIRRER	1	

ST2040T — ELECTRIC SUBMERSIBLE PUMP ASSY.

ST2040T ELECTRIC SUBMERSIBLE PUMP ASSY.

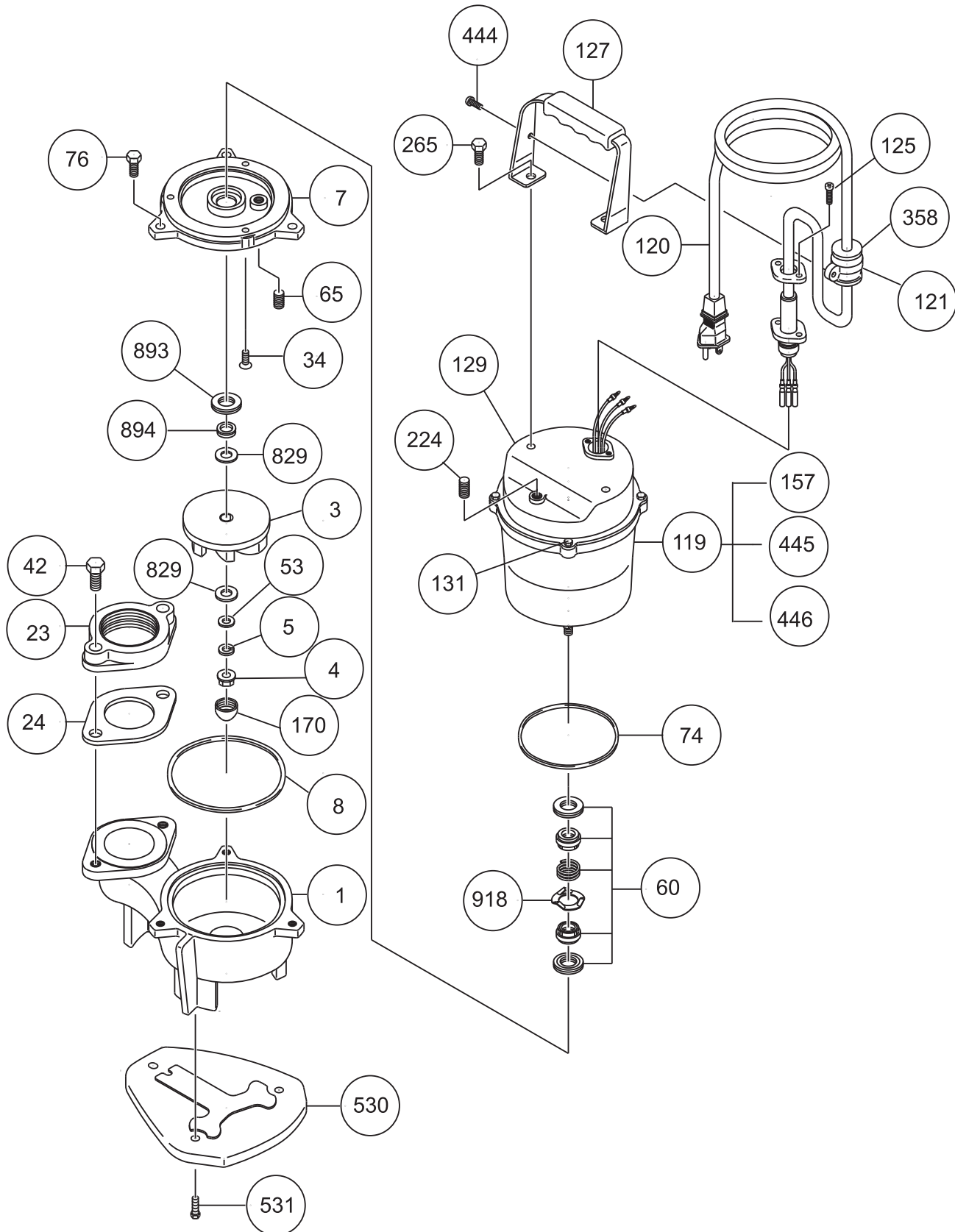

ST2040T — ELECTRIC SUBMERSIBLE PUMP ASSY.

ST2040T ELECTRIC SUBMERSIBLE PUMP ASSY.

<u>NO</u>	<u>PART NO</u>	<u>PART NAME</u>	<u>QTY.</u>	<u>REMARK</u>
1	020S2040T001	CASING	1	
3	020S500UL003	IMPELLER, NITRILE RUBBER	1	STANDARD
3	020S500UL003SP	IMPELLER, HEAT TREATED, ST2040T	1	OPTION
4	020S500UL004	IMPELLER NUT	1	
5	020S500UL005	SPRING WASHER	1	
7	020S2040T007	CASING COVER	1	
8	0202005T008	CASING PACKING	1	
23	020S2040T023	COMPANION FLANGE	1	
24	0202005T024	PACKING	1	
34	020S2037034	SCREW	3	
42	020S2040T042	BOLT	2	
53	020S500UL053	WASHER	1	
60	020S500UL060	MECHANICAL SEAL	1	
65	020S2040T065	PLUG	1	
74	020S500UL074	PACKING	1	
76	020S2040T076	BOLT	3	
119	020S2047119	MOTOR	1	
120	0201503UL120	AC CORD W/CORD GLAND	1	
121	0201503121	CORD CLAMP	1	
125	0201503125	SCREW	2	
127	020S500UL127	CARRYING HANDLE	1	
129	020S2047129	FRAME COVER	1	
131	020S2047131	BOLT	3	
157	020S2047157	PACKING	1	
170	020S500UL170	IMPELLER NUT CAP	1	
224	0201503224	PLUG	1	
238	020S500UL238	SPACER	3	
265	020S2040T265	BOLT	2	
358	020S500UL358	AC CORD BAND	1	
444	020S500UL444	SCREW	1	
445	020S2047445	CAPACITOR	1	
446	020S2047446	THERMAL PROTECTOR	1	
530	0202005T530	BOTTOM PLATE	1	
531	0202005T531	BOLT	3	
829	020S500UL829	WASHER	2	
893	020S2040T893	SEAT WITH PACKING	1	
894	020S500UL894	V-RING	1	
918	020S500UL918	STIRRER	1	

ST2038P— ELECTRIC SUBMERSIBLE PUMP ASSY.

ST2038P - ELECTRIC SUBMERSIBLE PUMP ASSY.

ST-2038P

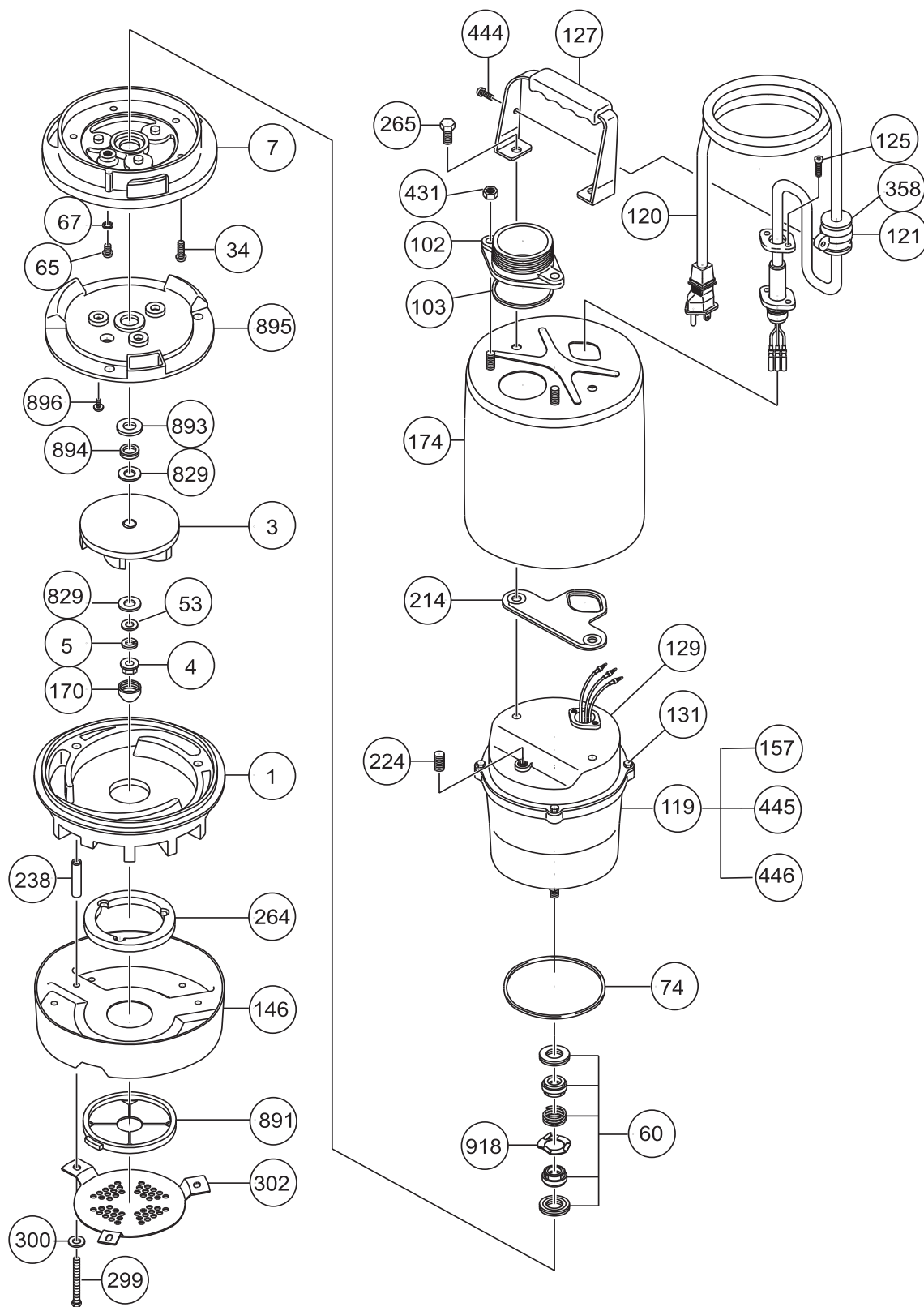

ST2038P— ELECTRIC SUBMERSIBLE PUMP ASSY.

ST2038P - ELECTRIC SUBMERSIBLE PUMP ASSY.

<u>NO</u>	<u>PART NO</u>	<u>PART NAME</u>	<u>QTY.</u>	<u>REMARK</u>
1	020S500UL001	CASING	1	
3	020S500UL003	IMPELLER	1	
4	020S500UL004	IMPELLER NUT	1	
5	020S500UL005	SPRING WASHER	1	
7	020S500UL007	CASING COVER	1	
34	020S2037034	SCREW	3	
53	020S500UL053	WASHER	1	
60	020S500UL060	MECHANICAL SEAL	1	
65	020S500UL065	PLUG	1	
67	020S500UL067	PACKING	1	
74	020S500UL074	PACKING	1	
102	0202005A102	DISCHARGE PORT	1	
103	0201503A103	PACKING	1	
119	020S2047119	MOTOR	1	
120	0201503UL120	AC CORD W/CORD GLAND	1	
121	0201503121	CORD CLAMP	1	
125	0201503125	SCREW	2	
127	020S500UL127	CARRYING HANDLE	1	
129	020S2047129	FRAME COVER	1	
131	020S2047131	BOLT	3	
146	020S500P146	STRAINER	1	
157	020S2047157	PACKING	1	
170	020S500UL170	IMPELLER NUT CAP	1	
174	020S2037174	OUTER PIPE	1	
214	020S500UL214	PACKING	1	
224	0201503224	PLUG	1	
238	020S500UL238	SPACER	3	
264	020S500P264	SPACER	1	
265	020S500UL265	BOLT	2	
299	020S500UL299	BOLT	3	
300	020S500UL300	WASHER	3	
302	020S500P302	CHECK VALVE COVER	1	
358	020S500UL358	AC CORD BAND	1	
431	020S500UL431	NUT	2	
444	020S500UL444	SCREW	1	
445	020S2047445	CAPACITOR	1	
446	020S2047446	THERMAL PROTECTOR	1	
829	020S500UL829	WASHER	2	
891	020S500P891	CHECK VALVE	1	
893	020S500UL893	SEAT	1	
894	020S500UL894	V-RING	1	
895	020S500UL895	LINER	1	
896	020S500UL896	SCREW	3	
918	020S500UL918	STIRRER	1	

TERMS AND CONDITIONS OF SALE — PARTS

PAYMENT TERMS

Terms of payment for parts are net 30 days.

FREIGHT POLICY

All parts orders will be shipped collect or prepaid with the charges added to the invoice. All shipments are F.O.B. point of origin. Multiquip's responsibility ceases when a signed manifest has been obtained from the carrier, and any claim for shortage or damage must be settled between the consignee and the carrier.

MINIMUM ORDER

The minimum charge for orders from Multiquip is \$15.00 net. Customers will be asked for instructions regarding handling of orders not meeting this requirement.

RETURNED GOODS POLICY

Return shipments will be accepted and credit will be allowed, subject to the following provisions:

1. A Returned Material Authorization must be approved by Multiquip prior to shipment.
2. To obtain a Return Material Authorization, a list must be provided to Multiquip Parts Sales that defines item numbers, quantities, and descriptions of the items to be returned.
 - a. The parts numbers and descriptions must match the current parts price list.
 - b. The list must be typed or computer generated.
 - c. The list must state the reason(s) for the return.
 - d. The list must reference the sales order(s) or invoice(s) under which the items were originally purchased.
 - e. The list must include the name and phone number of the person requesting the RMA.
3. A copy of the Return Material Authorization must accompany the return shipment.
4. Freight is at the sender's expense. All parts must be returned freight prepaid to Multiquip's designated receiving point.

5. Parts must be in new and resalable condition, in the original Multiquip package (if any), and with Multiquip part numbers clearly marked.
6. The following items are not returnable:
 - a. Obsolete parts. (If an item is in the price book and shows as being replaced by another item, it is obsolete.)
 - b. Any parts with a limited shelf life (such as gaskets, seals, "O" rings, and other rubber parts) that were purchased more than six months prior to the return date.
 - c. Any line item with an extended dealer net price of less than \$5.00.
 - d. Special order items.
 - e. Electrical components.
 - f. Paint, chemicals, and lubricants.
 - g. Decals and paper products.
 - h. Items purchased in kits.
7. The sender will be notified of any material received that is not acceptable.
8. Such material will be held for five working days from notification, pending instructions. If a reply is not received within five days, the material will be returned to the sender at his expense.
9. Credit on returned parts will be issued at dealer net price at time of the original purchase, less a 15% restocking charge.
10. In cases where an item is accepted, for which the original purchase document can not be determined, the price will be based on the list price that was effective twelve months prior to the RMA date.
11. Credit issued will be applied to future purchases only.

PRICING AND REBATES

Prices are subject to change without prior notice. Price changes are effective on a specific date and all orders received on or after that date will be billed at the revised price. Rebates for price declines and added charges for price increases will not be made for stock on hand at the time of any price change.

Multiquip reserves the right to quote and sell direct to Government agencies, and to Original Equipment Manufacturer accounts who use our products as integral parts of their own products.

SPECIAL EXPEDITING SERVICE

A \$35.00 surcharge will be added to the invoice for special handling including bus shipments, insured parcel post or in cases where Multiquip must personally deliver the parts to the carrier.

LIMITATIONS OF SELLER'S LIABILITY

Multiquip shall not be liable hereunder for damages in excess of the purchase price of the item with respect to which damages are claimed, and in no event shall Multiquip be liable for loss of profit or good will or for any other special, consequential or incidental damages.

LIMITATION OF WARRANTIES

No warranties, express or implied, are made in connection with the sale of parts or trade accessories nor as to any engine not manufactured by Multiquip. Such warranties made in connection with the sale of new, complete units are made exclusively by a statement of warranty packaged with such units, and Multiquip neither assumes nor authorizes any person to assume for it any other obligation or liability whatever in connection with the sale of its products. Apart from such written statement of warranty, there are no warranties, express, implied or statutory, which extend beyond the description of the products on the face hereof.

Effective: February 22, 2006

OPERATION AND PARTS MANUAL

HERE'S HOW TO GET HELP

PLEASE HAVE THE MODEL AND SERIAL
NUMBER ON-HAND WHEN CALLING

UNITED STATES

Multiquip Corporate Office

18910 Wilmington Ave. Tel. (800) 421-1244
Carson, CA 90746 Fax (800) 537-3927
Contact: mq@multiquip.com

Mayco Parts

800-306-2926 Fax: 800-672-7877
310-537-3700 Fax: 310-637-3284

Service Department

800-421-1244 Fax: 310-537-4259
310-537-3700

MQ Parts Department

800-427-1244 Fax: 800-672-7877
310-537-3700 Fax: 310-637-3284

Warranty Department

800-421-1244, Ext. 279 Fax: 310-537-1173
310-537-3700, Ext. 279

Technical Assistance

800-478-1244 Fax: 310-631-5032

MEXICO

MQ Cipsa

Carr. Fed. Mexico-Puebla KM 126.5 Tel: (52) 222-225-9900
Momoxpan, Cholula, Puebla 72760 Mexico Fax: (52) 222-285-0420
Contact: pmastretta@cipsa.com.mx

UNITED KINGDOM

Multiquip (UK) Limited Head Office

Hanover Mill, Fitzroy Street, Tel: 0161 339 2223
Ashton-under-Lyne, Fax: 0161 339 3226
Lancashire OL7 0TL
Contact: sales@multiquip.co.uk

CANADA

Multiquip

4110 Industriel Boul. Tel: (450) 625-2244
Laval, Quebec, Canada H7L 6V3 Tel: (877) 963-4411
Contact: jmartin@multiquip.com Fax: (450) 625-8664

© COPYRIGHT 2010, MULTIQUIP INC.

Multiquip Inc and the MQ logo are registered trademarks of Multiquip Inc. and may not be used, reproduced, or altered without written permission. All other trademarks are the property of their respective owners and used with permission.

This manual MUST accompany the equipment at all times. This manual is considered a permanent part of the equipment and should remain with the unit if resold.

The information and specifications included in this publication were in effect at the time of approval for printing. Illustrations, descriptions, references and technical data contained in this manual are for guidance only and may not be considered as binding. Multiquip Inc. reserves the right to discontinue or change specifications, design or the information published in this publication at any time without notice and without incurring any obligations.

Your Local Dealer is:

