



PRESSURE WASHER BREAKDOWN

BE275HAS





PRESSURE WASHER BREAKDOWN

BE275HAS

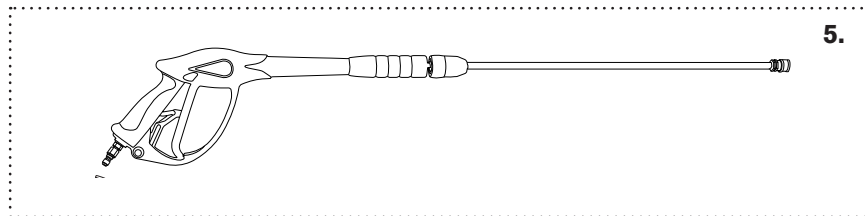
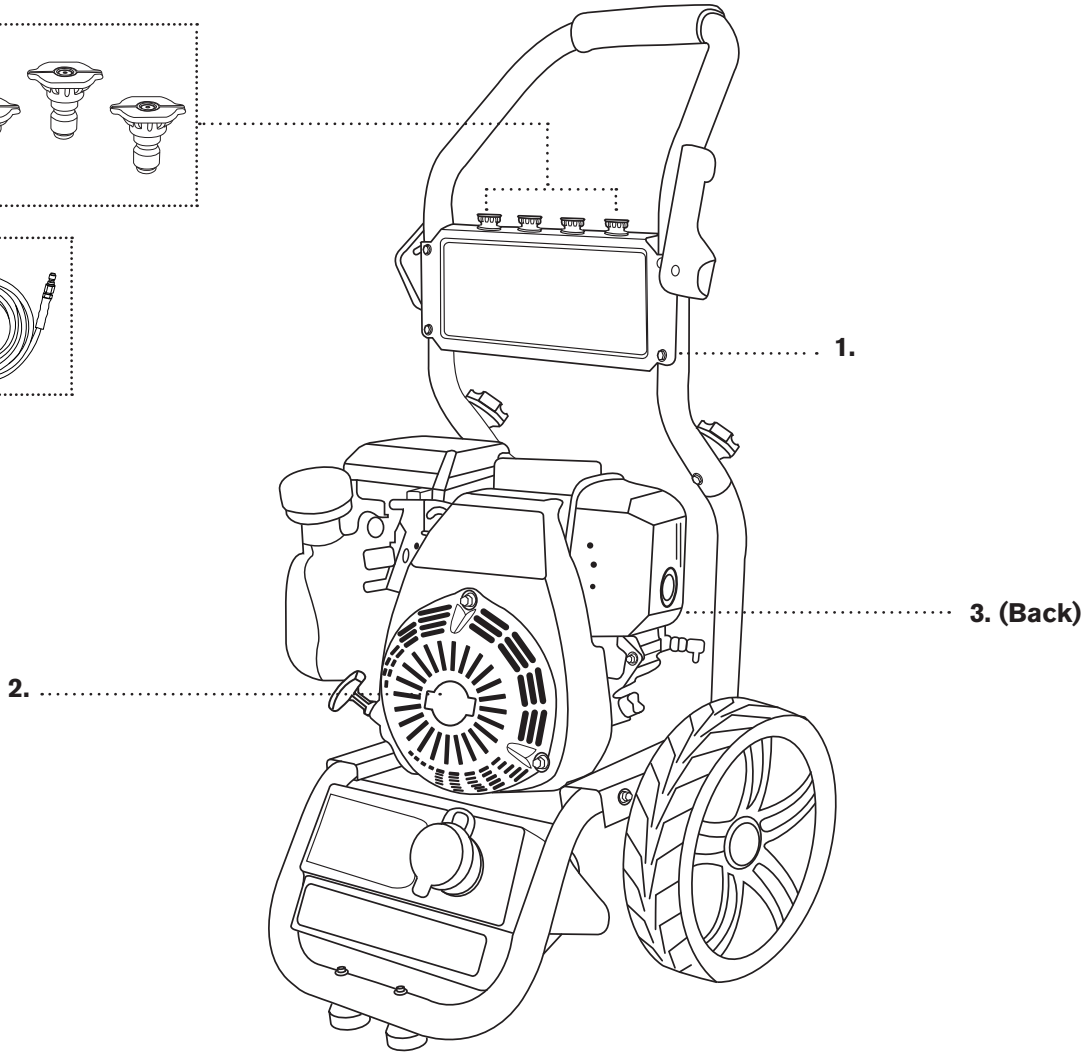
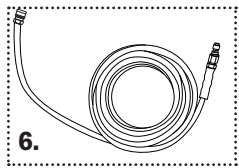
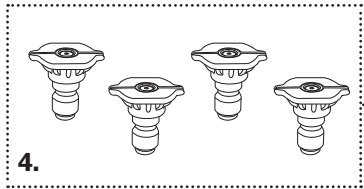

REF #	DESCRIPTION	PART #
1	Frame (wheels included)	85.600.122H
2	Engine - Honda GC160	85.510.052R
3	Pump - AR RMV25G24D	85.120.039B
4	Nozzle Set	85.210.030
5	Gun Wand	85.205.051
6	Hose 25' x 1/4"	85.225.125



PRESSURE WASHER BREAKDOWN

BE275HAS

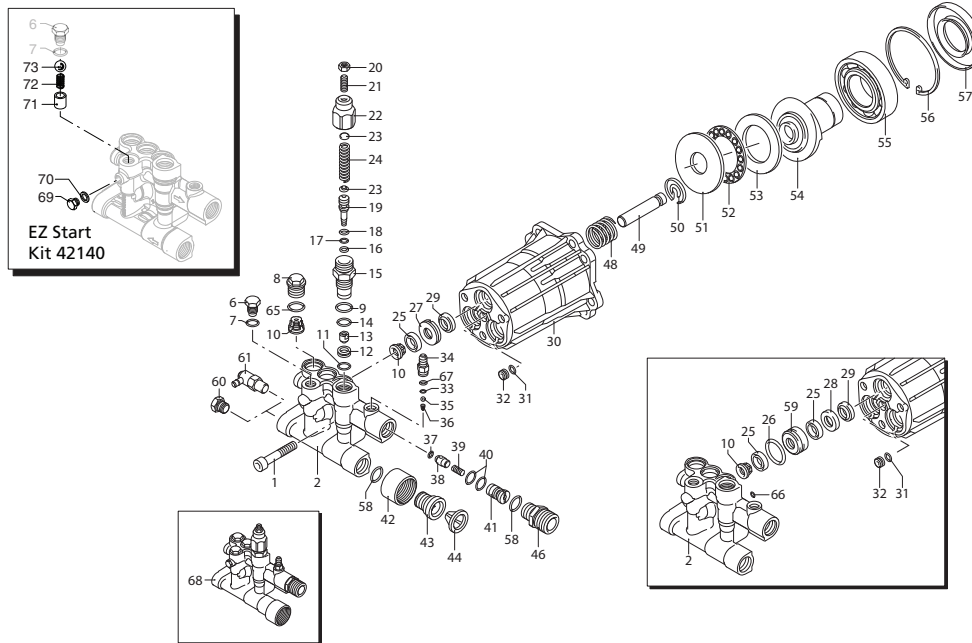

Repair Kits

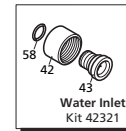
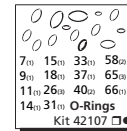
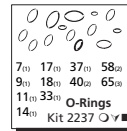
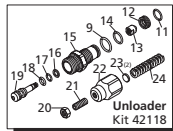

Pos	Code	Description	Qty	Pos	Code	Description	Qty	Pos	Code	Description	Qty
1	380410	Screw	(221 in/lbs) √ 3	30	2840230	Pump body	1	57	2841050	Ring	1
	800220	Screw	(221 in/lbs) □ 3	31	480560	O-Ring ø 6.75x1.78	1	58	2840890	O-Ring ø 14x2	2
	2841730	Head	∇ 1	32	2840710	Plug	1	59	1683500	Oil seal	3
	2840022	Head	■ 1	33	480480	O-Ring ø 4.48x1.78	1	2840840	Plug	∇ 1	
	2840870	Head	○ 1	34	1982520	Hose tail ø 8	(35 in/lbs) 1	60	480650	Washer	1
	2841620	Head	□ 1	34	3700240	Hose tail ø 8	(35 in/lbs) √ 1	61	TPP1401/4A	Thermal relief valve	1
6	2840830	Screw	(89 in/lbs) 1	35	1250280	Ball	1	62	1060100	Ball	∇ 1
7	600180	O-Ring	ø 7.66x1.78	1	1560520	Spring	1	63	2840440	Seat	∇ 1
8	2841530	Valve cap	(221 in/lbs) 3	37	1460431	O-Ring ø 4x2.5	1	64	2840450	Spring	∇ 1
9	740290	O-Ring	ø 14x1.78	1	2841150	Shutter	1	65	2841520	O-Ring ø 13.5x1.8	3
10	2849051	Complete Valve	● 6	38	3700220	Jet	∇ 1	66	3400650	Plug	1
	2849050	Complete Valve	∇ ■ □ 6	39	1343580	Spring	1	67	480650	Washer	∇ 1
11	1470210	O-Ring	ø 9x1	1	800560	O-Ring ø 8.73x1.78	2	68	2849284	Complete head assembly	∇ ■ 1
12	2840770	Seat	● 1	40	2840340	Injector	1	69	2840840	Plug (EZ start pump only)	1
	2841080	Seat	∇ ■ □ 1	41	3700200	Detergent injector	∇ 1	70	480650	Washer (EZ start pump only)	1
13	2840760	Shutter	(27 in/lbs) 1	42	2840270	Fitting	○ ■ 1	71	2840441	Seat (EZ start pump only)	1
14	820510	O-Ring	ø 10.82x1.78	1	2841220	Fitting 3/4" NH	∇ □ 1	72	2840450	Spring (EZ start pump only)	1
15	2840750	Piston guide	(177 in/lbs) 1	43	2841230	Fitting Aluminium	(221 in/lbs) ∇ ● □ 1	73	1060100	Ball (EZ start pump only)	1
16	2760210	Ring	1	43	2840390	Fitting Brass	(221 in/lbs) □ 1				
17	660190	O-Ring	ø 6.07x1.78	1	44	7369	Filter	1			
18	2260100	O-Ring	ø 6.02x2.62	1	46	2840400	Fitting 3/8" G M	(221 in/lbs) □ 1			
19	2841140	Piston	1	46	2841380	Fitting	(221 in/lbs) ■ 1				
20	1060120	Nut M6	1	46	2841120	Fitting	(221 in/lbs) □ ∇ 1				
21	392840	Screw M6x16	1	48	2840060	Spring	3				
22	2760480	Insert	1	49	2840040	Piston ø 12	∇ □ 3				
23	1980220	Wobble plate	2	49	2840530	Piston ø 12	■ □ 3				
24	2760410	Spring	1	50	2840050	Lock	3				
25	2200141	Water seal	∇ □ 3	51	1980130	Fifth wheel	1				
	2200141	Water seal	□ 6	52	1980250	Fifth wheel	1				
26	770260	O-Ring	ø 23.52x1.78	3	53	1980240	Fifth wheel	1			
	770590	O-Ring	ø 21.95x1.78	3	54	2840050	Wobble plate	■ 1			
27	2840561	Bushing ø 12	3		2840900	Wobble plate	○ 1				
	2840550	Bushing ø 12	3		2840720	Wobble plate	∇ 1				
	2840540	Bushing ø 12	3		2840730	Wobble plate	□ 1				
28	2840561	Bushing	∇ 3	55	161060	Bearing	1				
29	1683500	Oil seal	∇ □ 3	56	161050	Ring ø 72	1				

AR64545 Oil
OIL CAPACITY - 2.2 OZ

Legend

∅ 12	∅ 12	∅ 12
For ○	For ●	For □
RMV2G25 (Brass)	RMV25G30 (Brass)	RMV22G25-EZ (Brass)
		RMV25G30-EZ (Brass)
For ■		For ∇
RMV25G24 (Alum)		RMV22G24 (Alum)



PRESSURE WASHER BREAKDOWN

BE275HAS

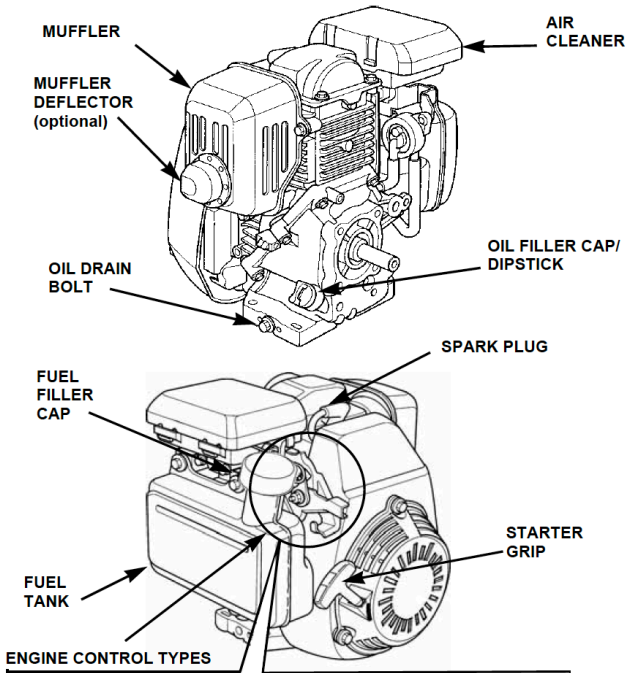

TYPE 1: MANUAL THROTTLE / MANUAL CHOKE

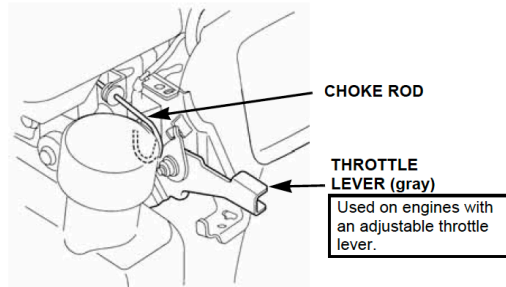

TYPE 2: FIXED THROTTLE / IGNITION SWITCH LEVER / MANUAL CHOKE

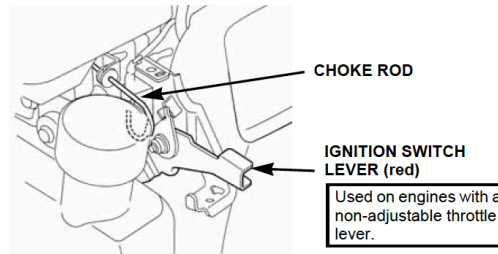

TYPE 3: FIXED THROTTLE / ENGINE STOP SWITCH / MANUAL CHOKE

