



# ***PRESSURE WASHER***

**OPERATION MANUAL**



## **TABLE OF CONTENTS**

### **Introduction**

- 4 Using the Operators Manual

### **Product Identification**

- 5 Pressure Washer
- 5 Engine

### **Safety**

- 6 Understanding the Machine Safety Decal
- 7 Safety Rules
- 7 Hazard Symbols and Meanings

### **Gas Washer Components**

- 14 Component Chart

### **Assembly**

- 15 Unpack the Pressure Washer
- 15 Attach Handle

### **Pre-Operation Checklist**

- 16 Follow the Checklist Below
- 16 Connect Hose and Water Supply to Pump

### **Starting Your Washer**

- 17 How to Start your Pressure Washer

### **Shutting Down Your Washer**

- 21 How to Shut Down your Pressure Washer

### **Electric Washer Components**

- 22 Component Chart



## **Power Cord Connection**

23 Connection Safety

## **Starting Your Electric Washer**

25 How to Start your Pressure Washer

## **Shutting Down Your Electric Washer**

28 How to Shut Down your Pressure Washer

## **Spray Tips**

29 How to Use Spray Tips

29 Change Spray Tips

29 Usage Tips

## **Using Black Soap Nozzle**

30 Apply Detergent

## **Trouble Shooting**

31 Gas Engine Trouble Shooting Chart

32 Electric Motor Trouble Shooting Chart

33 Pump Trouble Shooting Chart

## **Storage**

34 Winter Storage

34 Long Term Storage

34 Protect Fuel System

34 Storing the Engine

35 Other Storage Tips



## INTRODUCTION



**Attention: Read through the complete manual prior to the initial use of your pressure washer.**

### **Using the Operator's manual**

The operating manual is an important part of your pressure washer and should be read thoroughly before initial use, and referred to often to make sure adequate safety and service concerns are being addressed.

Reading the owner's manual thoroughly will help avoid any personal injury or damage to your machine. The information in this manual will offer you the most effective tools for cleaning as well as the safest. By knowing how best to operate this machine you will be better positioned to show others who may also operate the unit.

This manual contains information for the complete range of BE pressure washers, and is placed in order starting from the safety requirements to the operating functions of your machine. You can refer back to the manual at any time to help troubleshoot any specific operating functions, so store it with the machine at all times.

### **Notice**

Actual pressure released at the point of discharge may vary by machine due to varying factors including: Volume of water being fed to the machine by the water source, the inclusion of a Chemical injector in the line, or variations in Engine performance



## **Record Identification Numbers**

### **Pressure Washer**

If you need to contact an Authorized Dealer or Customer Service line (1-866-850-6662) for information on servicing, always provide the product model and identification numbers.

You will need to locate the model and serial number for the machine and record the information in the places provided below.

**Date of Purchase:**

**Dealer Name:**

**Dealer Phone:**

## **Product Identification Numbers**

**Model Number:**

**Serial Number:**

## **Engine**

**Horse Power:**

### Understanding the Machine Safety Labels

The machine safety label shown below is placed on your machine to draw attention to potential safety hazards.

## WARNING!



Do not leave unit running longer than 1 minute without using or pump will overheat. *Ne pas laisser fonctionner inutilement l'unité pendant plus d'une minute.*



Do not let unit freeze. *La pompe risquerait de surchauffer.*



Always wear eye protection. *Porter toujours des lunettes de sécurité.*



High pressure sprays can cause serious bodily injury. Use with Caution. *Les jets à haute pression peuvent causer de graves blessures corporelles. Soyez prudent.*



Warranty is void if you exceed preset pressure causing severe damage to gauge and unloader. *Ne pas exposer cette unité au gel la garantie n'est pas applicable si vous exédez la mesure de pression PSI indiqué. Causez beaucoup de dommage à la indicateur et la dechargeur.*

## Save these Instructions

### Safety Rules



This is the safety alert symbol. It is used to alert you to potential personal injury hazards. Obey all safety messages that follow this symbol to avoid possible injury or death.

The safety alert symbol (▲) is used with a signal word (DANGER, CAUTION, WARNING), a pictorial and/or a safety message to alert you to hazards.













**DANGER** indicates a hazard which, if not avoided, will result in death or serious injury.

**WARNING** indicates a hazard which, if not avoided, could result in death or serious injury.

**CAUTION** indicates a hazard which, if not avoided, might result in minor or moderate injury.

**NOTICE** indicates a situation that could result in equipment damage. Follow safety messages to avoid or reduce the risk of injury or death.

### Hazard Symbols and Meanings

			
EXPLOSION	FIRE	ELECTRIC SHOCK	TOXIC FUMES
			
KICKBACK	HOT SURFACE	FLYING OBJECTS	SLIPPERY
			
FALL	FLUID INJECTION	MOVING PARTS	READ MANUAL

**⚠ WARNING**



Running engine gives off carbon monoxide, an odorless, colorless, poison gas.

Breathing carbon monoxide can cause headache, fatigue, dizziness, vomiting, confusion, seizures, nausea, fainting or death.

Some chemicals or detergents may be harmful if inhaled or ingested, causing severe nausea, fainting, or poisoning.

- Operate pressure washer **ONLY** outdoors.
- Keep exhaust gas from entering a confined area through windows, doors, ventilation intakes, or other openings.
- **DO NOT** start or run engine indoors or in an enclosed area, even if windows and doors are open.
- Use a respirator or mask whenever there is a chance that vapors may be inhaled.
- Read all instructions with mask so you are certain the mask will provide the necessary protection against inhaling harmful vapors.

**⚠ WARNING**



Use of pressure washer can create puddles and slippery surfaces.



Kickback from spray gun can cause you to fall.

- Operate pressure washer from a stable surface.
- The cleaning area should have adequate slopes and drainage to reduce the possibility of a fall due to slippery surfaces.
- Be extremely careful if you must use the pressure washer from a ladder, scaffolding, or any other similar location.
- Firmly grasp spray gun with both hands when using high pressure spray to avoid injury when spray gun kicks back.



### WARNING



Fuel and its vapors are extremely flammable and explosive.



Fire or explosion can cause severe burns or death.

#### **When Adding or Draining Fuel**

- Turn pressure washer OFF and let it cool at least 2 minutes before removing fuel cap. Loosen cap slowly to relieve pressure in tank.
- Fill or drain fuel tank outdoors.
- DO NOT overfill tank. Allow space for fuel expansion.
- If fuel spills, wait until it evaporates before starting engine.
- Keep fuel away from sparks, open flames, pilot lights, heat, and other ignition sources.
- DO NOT light a cigarette or smoke.

#### **When Starting Equipment**

- Ensure spark plug, muffler, fuel cap, and air cleaner are in place.
- DO NOT crank engine with spark plug removed.

#### **When Operating Equipment**

- DO NOT tip engine or equipment at angle which causes fuel to spill.
- DO NOT spray flammable liquids.

#### **When Transporting or Repairing Equipment**

- Transport/repair with fuel tank EMPTY or with fuel shutoff valve OFF.
- Disconnect spark plug wire.

#### **When Storing Fuel or Equipment with Fuel in Tank**

- Store away from furnaces, stoves, water heaters, clothes dryers, or other appliances that have pilot light or other ignition source because they can ignite fuel vapors.

### WARNING



Risk of electrocution.

Contact with power source can cause electric shock or burn.

- NEVER spray near power source.

**⚠ WARNING**



Starter cord kickback (rapid retraction) can result in bodily injury. Kickback will pull hand and arm toward engine faster than you can let go.

Broken bones, fractures, bruises, or sprains could result.

- NEVER pull starter cord without first relieving spray gun pressure.
- When starting engine, pull cord slowly until resistance is felt and then pull rapidly to avoid kickback.
- After each starting attempt, where engine fails to run, always point spray gun in safe direction and squeeze spray gun trigger to release high pressure.
- Firmly grasp spray gun with both hands when using high pressure spray to avoid injury when spray gun kicks back.

**⚠ WARNING**



Contact with muffler area can result in serious burns.

Exhaust heat/gases can ignite combustibles, structures or damage fuel tank causing a fire.

- DO NOT touch hot parts and AVOID hot exhaust gases.
- Allow equipment to cool before touching.
- Keep at least 5 feet (1.5 m) of clearance on all sides of pressure washer including overhead.

 **WARNING**

Unintentional sparking can result in fire or electric shock.

**When Adjusting or Making Repairs to Your Pressure Washer**

- Disconnect the spark plug wire from the spark plug and place the wire where it cannot contact spark plug.

**When Testing for Engine Spark**

- Use approved spark plug tester.
- **DO NOT** check for spark with spark plug removed.

 **WARNING**

The high pressure stream of water that this equipment produces can cut through skin and its underlying tissues, leading to serious injury and possible amputation.

Spray gun traps high water pressure, even when engine is stopped and water is disconnected, which can cause injury.

- **DO NOT** allow **CHILDREN** to operate pressure washer.
- **NEVER** repair high pressure hose. Replace it.
- **NEVER** repair leaking connections with sealant of any kind. Replace o-ring or seal.
- **NEVER** connect high pressure hose to nozzle extension.
- Keep high pressure hose connected to pump and spray gun while system is pressurized.
- **ALWAYS** point spray gun in safe direction and squeeze spray gun trigger, to release high pressure, every time you stop engine.
- **NEVER** aim spray gun at people, animals, or plants.
- **DO NOT** secure spray gun in open position.
- **DO NOT** leave spray gun unattended while machine is running.
- **NEVER** use a spray gun which does not have a trigger lock or trigger guard in place and in working order.
- Always be certain spray gun, nozzles and accessories are correctly attached.

**⚠ WARNING**



Starter and other rotating parts can entangle hands, hair, clothing, or accessories.

- NEVER operate pressure washer without protective housing or covers.
- DO NOT wear loose clothing, jewelry or anything that may be caught in the starter or other rotating parts.
- Tie up long hair and remove jewelry.

**⚠ WARNING**



Risk of eye injury.

Spray can splash back or propel objects.

- Always wear safety goggles when using this equipment or in vicinity of where equipment is in use.
- Before starting the pressure washer, be sure you are wearing adequate safety goggles.
- NEVER substitute safety glasses for safety goggles.

**NOTICE**

High pressure spray may damage fragile items including glass.

- DO NOT point spray gun at glass when using red 0° spray tip.
- NEVER aim spray gun at plants.

**NOTICE**

Improper treatment of pressure washer can damage it and shorten its life.

- If you have questions about intended use, ask dealer or contact nearest authorized dealer.
- NEVER operate units with broken or missing parts, or without protective housing or covers.
- DO NOT by-pass any safety device on this machine.
- DO NOT tamper with governed speed.
- DO NOT operate pressure washer above rated pressure.
- DO NOT modify pressure washer in any way.
- Before starting pressure washer in cold weather, check all parts of the equipment to be sure ice has not formed there.
- NEVER move machine by pulling on hoses. Use handle provided on unit.
- Check fuel system for leaks or signs of deterioration, such as chafed or spongy hose, loose or missing clamps, or damaged tank or cap. Correct all defects before operating pressure washer.



Read this operator's manual and safety rules before operating your pressure washer.

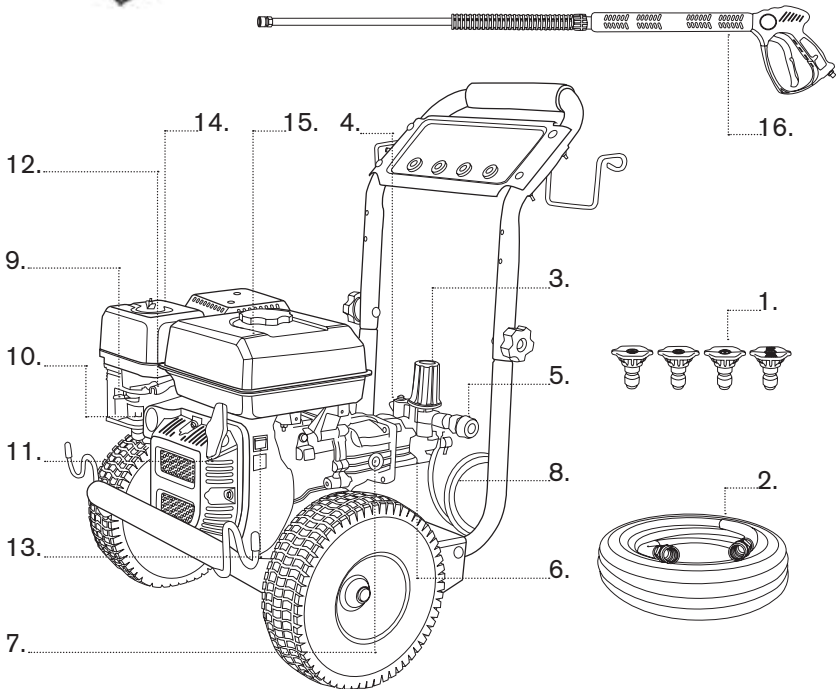

1. **Spray Tips** Detergent, 0°, 15°, and 40°: for various high pressure cleaning applications.
2. **High Pressure Hose** Connect one end to water pump and the other end to spray gun.
3. **Pressure Control Knob** Varies pressure of high pressure spray.
4. **Water Inlet** Connection for garden hose.
5. **High Pressure Outlet** Connection for high pressure hose.
6. **Pump** Develops high pressure.
7. **Oil Level Indicator** Level should be at halfway
8. **Detergent Siphoning Tube/Filter** Use to siphon pressure washer safe detergent into the low pressure stream.
9. **Choke Lever** Prepares a cold engine for starting.
10. **Fuel Valve** Used to turn fuel supply on and off to engine.
11. **Recoil Starter** Used for starting the engine manually.
12. **Throttle Lever** Sets engine in starting mode for recoil starter.
13. **Engine Switch** Set switch to "On" for recoil starting. Set switch to "Off" to stop a running engine.
14. **Air Filter** Protects engine by filtering dust and debris out of intake air.
15. **Fuel Tank** Fill tank with regular unleaded fuel. Always leave room for fuel expansion.
16. **Spray Gun Extension with Quick Connect Nozzles** Controls the application of water onto cleaning surface with trigger device. Includes trigger lock. Allows you to switch between five different spray tips.

Your pressure washer requires some assembly and is ready for use after it has been properly serviced with the recommended oil and fuel.

If you have any problems with the assembly of your pressure washer, please call the pressure washer help line at **1-866-850-6662**. If calling for assistance, please have the model and serial number from the data tag available.

### Unpack the Pressure Washer

1. Remove the parts bag, accessories, and inserts included with pressure washer.
2. Open box completely by cutting each corner from top to bottom.
3. Ensure you have all included items prior to assembly.

### Attach Handle

1. Place handle (A) onto handle supports (B) connected to main unit. Make sure holes (C) in handle align with holes on handle supports.

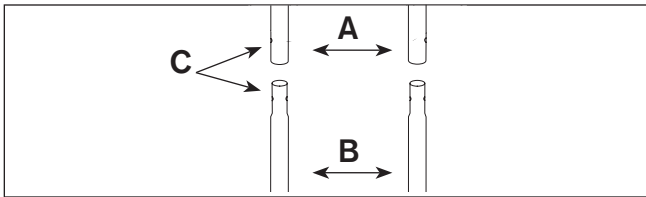

**NOTE:** It may be necessary to move the handle supports from side to side in order to align the handle so it will slide over the handle supports.

2. Insert carriage bolts through holes from outside of unit and attach a plastic knob from inside of unit. Tighten by hand.

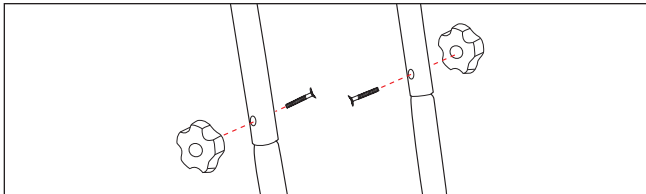

3. Insert multi-colored quick connect spray tips and other supplied accessories in spaces provided on handle.

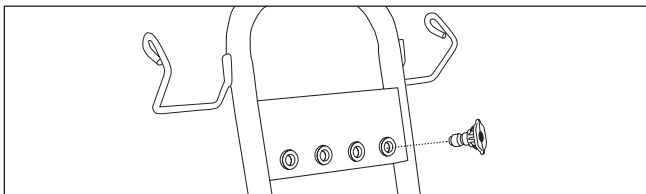



## PRE-OPERATION CHECKLIST

### Follow the Checklist Below Prior to Using the Machine Each Time

1. Check to ensure the engine oil is at the proper level.

#### Use SAE 10W30 Oil

2. Check the 2 handle knobs to ensure they are tight and will not vibrate loose.
3. Add fuel to the gas tank.
4. Connect and tighten the garden hose to the GHA (garden hose inlet) connection.

**\*\* Water must be turned on prior to starting the washer, pull the spray trigger to ensure water is moving through the lines and out the nozzle without any leaks before starting the unit.\*\***

5. Review the safety guidelines in the manual prior to starting the unit.

If you have any issues operating the pressure washer, call the customer service line at **1-866-850-6662**.

### WARNING



Always check the level of the engine oil prior to starting the washer.

- Failure to do so could cause the engine to seize if the oil is low or empty.

### Connect Hose and Water Supply to Pump Before Starting

### WARNING



DO NOT start your pressure washer without the water supply turned on.

- Failure to do so will result in damaging the pump from overheating and void the warranty.



## How to Start Your Pressure Washer

To start your pressure washer for the first time, follow these instructions step-by-step. This starting information also applies if you have let the pressure washer sit idle for at least a day.

1. Place pressure washer near an outside water source capable of supplying water at a flow rate greater than 3.8 gallons per minute and no less than 20 PSI at pressure washer end of garden hose. **DO NOT** siphon supply water.
2. Make sure unit is in a level position.
3. Connect garden hose to water inlet on pressure washer pump.

### NOTICE

**DO NOT** run the pump without the water supply connected and turned on.

- Damage to equipment resulting from failure to follow this instruction will void warranty.

4. Attach wand extension to spray gun. Tighten by hand.

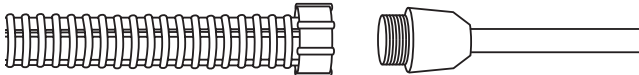

5. Choose desired spray tip, pull back nozzle extension collar, insert spray tip and release collar. Tug on spray tip to make sure it is securely in place. See *Spray Tips*.

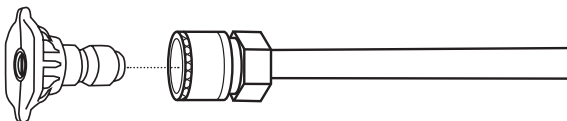

6. Uncoil high pressure hose and attach quick connect end of hose to base of spray gun. Pull down on collar of quick connect, slide onto spray gun and let go of collar. Tug on hose to be sure of tight connection.

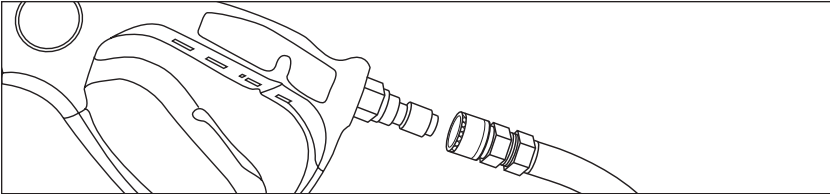

### **⚠ WARNING**



The high pressure stream of water that this equipment produces can cut through skin and its underlying tissues, leading to serious injury and possible amputation.

- NEVER connect high pressure hose to nozzle extension.
- Keep high pressure hose connected to pump and spray gun while system is pressurized.
- Always be certain spray gun, nozzles and accessories are correctly attached.

7. Similarly, attach other end of high pressure hose to high pressure outlet (A) on pump. Pull down on collar of quick connect, slide onto pump and let go of collar. Pull on hose to be sure of tight connection.

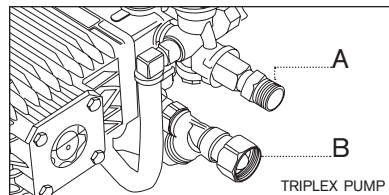
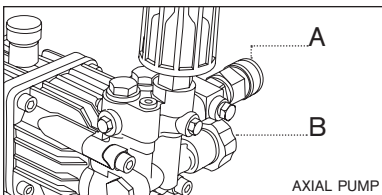

### **Pump Uses 30W Non-Detergent Mineral Oil**

8. Turn Water Supply on, point gun in a safe direction and squeeze the trigger to purge the pump of air and debris. Do this for at least 30 seconds.
9. Take a look at all connections to make sure there are no leaks or loose connections.

**IMPORTANT: DO NOT** siphon standing water for the water supply. Use **ONLY** cold water (less than 100°F).

10. Connect the garden hose to the water inlet. Tighten by hand.
11. To start the machine, locate the engine switch on the side of the engine, and switch it to the ON position. (see component chart to locate switch) Check to ensure fuel valve is in the ON position and if starting cold apply the choke.
12. Pull recoil cord slowly until resistance is felt and then pull rapidly to avoid kickback. Make sure to position yourself in a balanced position. **DO NOT** place hand on engine muffler for balance, this will result in severe burn.

## **WARNING**



Running engine gives off carbon monoxide, an odorless, colorless, poison gas.

Breathing carbon monoxide can cause headache, fatigue, dizziness, vomiting, confusion, seizures, nausea, fainting or death.

- Operate pressure washer **ONLY** outdoors.
- Keep exhaust gas from entering a confined area through windows, doors, ventilation intakes, or other openings.
- **DO NOT** start or run engine indoors or in an enclosed area, even if windows and doors are open.

**IMPORTANT:** Before starting the pressure washer, be sure you are wearing adequate safety goggles.

## **WARNING**



Risk of eye injury.

Spray can splash back or propel objects.

- Always wear safety goggles when using this equipment or in vicinity of where equipment is in use.
- Before starting the pressure washer, be sure you are wearing adequate safety goggles.
- **NEVER** substitute safety glasses for safety goggles.

**⚠ WARNING**

Starter cord kickback (rapid retraction) can result in bodily injury. Kickback will pull hand and arm toward engine faster than you can let go.

Broken bones, fractures, bruises, or sprains could result.

- NEVER pull starter cord without first relieving spray gun pressure.
- When starting engine, pull cord slowly until resistance is felt and then pull rapidly to avoid kickback.
- After each starting attempt, where engine fails to run, always point spray gun in safe direction and squeeze spray gun trigger to release high pressure.
- Firmly grasp spray gun with both hands when using high pressure spray to avoid injury when spray gun kicks back.

**⚠ WARNING**

The high pressure stream of water that this equipment produces can cut through skin and its underlying tissues, leading to serious injury and possible amputation.

Spray gun traps high water pressure, even when engine is stopped and water is disconnected, which can cause injury.

- DO NOT allow CHILDREN to operate pressure washer.
- NEVER repair high pressure hose. Replace it.
- NEVER repair leaking connections with sealant of any kind. Replace o-ring or seal.
- NEVER connect high pressure hose to nozzle extension.
- Keep high pressure hose connected to pump and spray gun while system is pressurized.
- ALWAYS point spray gun in safe direction and squeeze spray gun trigger, to release high pressure, every time you stop engine.
- NEVER aim spray gun at people, animals, or plants.
- DO NOT secure spray gun in open position.
- DO NOT leave spray gun unattended while machine is running.
- NEVER use a spray gun which does not have a trigger lock or trigger guard in place and in working order.
- ALWAYS be certain spray gun, nozzles and accessories are correctly attached.



<b>⚠ WARNING</b>	
	Contact with muffler area can result in serious burns. Exhaust heat/gases can ignite combustibles, structures or damage fuel tank causing a fire.
<ul style="list-style-type: none"><li>▪ DO NOT touch hot parts and AVOID hot exhaust gases.</li><li>▪ Allow equipment to cool before touching.</li><li>▪ Keep at least 5 feet (1.5 m) of clearance on all sides of pressure washer including overhead.</li></ul>	

### How to Shut Down Your Pressure Washer

1. Release spray gun trigger and let engine idle down.
2. Turn the engine switch to the OFF position.
3. ALWAYS point spray gun in a safe direction, squeeze spray gun trigger to release retained high water pressure.

**IMPORTANT:** Spray gun traps high water pressure, even when engine is stopped and water is disconnected. Couplings will not release if under pressure.

<b>⚠ WARNING</b>	
	The high pressure stream of water that this equipment produces can cut through skin and its underlying tissues, leading to serious injury and possible amputation.  Spray gun traps high water pressure, even when engine is stopped and water is disconnected, which can cause injury.
<ul style="list-style-type: none"><li>▪ Keep high pressure hose connected to pump and spray gun while system is pressurized.</li><li>▪ ALWAYS point spray gun in safe direction and squeeze spray gun trigger, to release high pressure, every time you stop engine.</li></ul>	



Read this operator's manual and safety rules before operating your pressure washer.

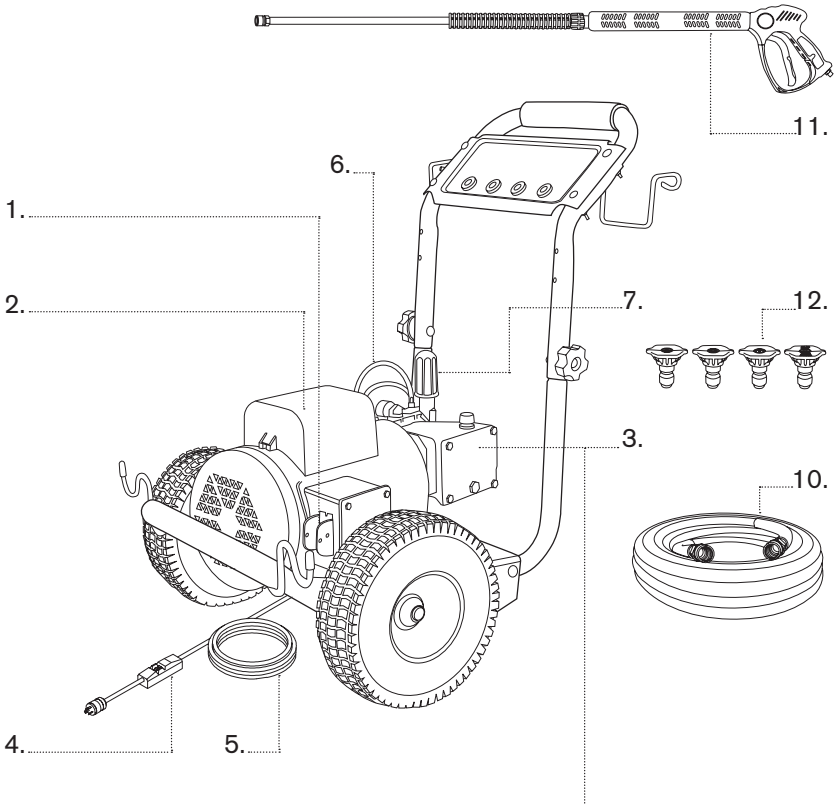

1. ON/OFF Switch
2. Motor
3. Pump
4. GFCI
5. Power Cord
6. Detergent Hose
7. Adjustable Unloader Knob
8. Water Inlet
9. Water Outlet
10. High Pressure Hose
11. Gun/Wand Assembly
12. Quick Connect Nozzles

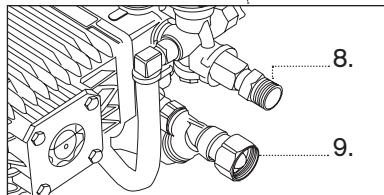

## **WARNING**



Risk of electrocution.

This unit must be connected to a properly grounded outlet.

- DO NOT use an adapter or remove the third grounding prong.
- To reduce the risk of electrocution, keep all connections dry and off the ground.
- DO NOT touch plug with wet hands.

1. Make certain the motor switch is in the “OFF” position.
2. Ensure electrical supply is identical to the specifications listed on the pressure washer data plate.
3. **GROUNDING INSTRUCTIONS:** This product must be grounded. If it should malfunction or breakdown, grounding provides a path of least resistance for electric current to reduce the risk of electric shock. This product is equipped with a cord having an equipment-grounding conductor. The plug must be plugged into an appropriate outlet that is properly installed and grounded in accordance with all local codes and ordinances.
4. **DANGER:** Improper connection of the equipment-grounding conductor can result in a risk of electrocution. Check with a qualified electrician or service personnel if you are in doubt as to whether the outlet is properly grounded. Do not modify the plug - if it will not fit the outlet, have a proper outlet installed by a qualified electrician. Do not use any type of adaptor with this product.
5. **GROUND FAULT CIRCUIT INTERRUPTER PROTECTION:** This pressure washer may be provided with a Ground Fault Circuit Interrupter (GFCI) built into the plug or the power supply cord, test the GFCI each time it is plugged into an outlet according to instructions on the GFCI. DO NOT use the pressure washer if the test fails! The GFCI provides additional protection from the risk of electric shock. Should replacement of the plug or cord become necessary, use only identical replacement parts that include GFCI protection.



## **POWER CORD CONNECTION**

6. WE DO NOT RECOMMEND THE USE OF EXTENSION CORDS. If use of an extension cord is unavoidable, it must be plugged into a GFCI found in circuit boxes or protected receptacles. Use only 3-wire extension cords that have 3-prong grounding-type plugs and 3-pole cord connectors that accept the plug from the product. Use only extension cords that are intended for outdoor use. These extension cords are identified by a marking "Acceptable for use with outdoor appliances; store indoors while not in use." Use only extension cords having an electrical rating not less than the rating of the product. Do not use damaged extension cords. Examine extension cord before using and replace if damaged. Do not abuse extension cord and do not pull on any cord to disconnect. Keep cord away from heat and sharp edges. Always connect or disconnect the extension cord from the receptacle before connecting or disconnecting the product from the extension cord.
7. Ensure the area between the pressure washer cord and outlet is kept dry.
8. Insert the male plug into a grounded AC outlet. **DO NOT** use an adapter **OR** remove the grounding plug!



## How to Start Your Pressure Washer

To start your pressure washer for the first time, follow these instructions step-by-step. This starting information also applies if you have let the pressure washer sit idle for at least a day.

1. Place pressure washer near an outside water source capable of supplying water at a flow rate greater than 3.8 gallons per minute and no less than 20 PSI at pressure washer end of garden hose. **DO NOT** siphon supply water.
2. Make sure unit is in a level position.
3. Connect garden hose to water inlet on pressure washer pump.

### NOTICE

**DO NOT** run the pump without the water supply connected and turned on.

- Damage to equipment resulting from failure to follow this instruction will void warranty.

4. Attach wand extension to spray gun. Tighten by hand.

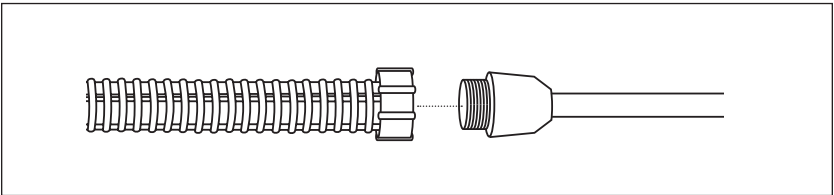

5. Choose desired spray tip, pull back nozzle extension collar, insert spray tip and release collar. Tug on spray tip to make sure it is securely in place. See *Spray Tips*.

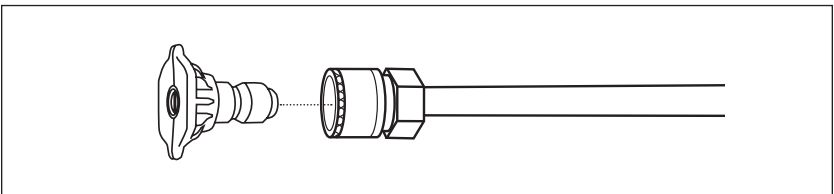

6. Uncoil high pressure hose and attach quick connect end of hose to base of spray gun. Pull down on collar of quick connect, slide onto spray gun and let go of collar. Tug on hose to be sure of tight connection.

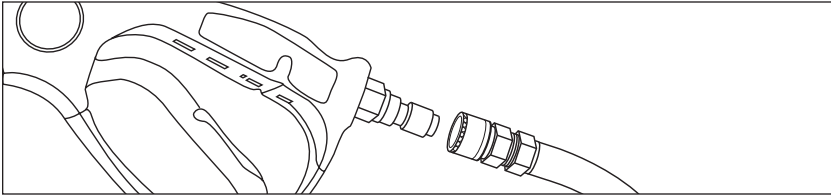

### **⚠ WARNING**



The high pressure stream of water that this equipment produces can cut through skin and its underlying tissues, leading to serious injury and possible amputation.

- NEVER connect high pressure hose to nozzle extension.
- Keep high pressure hose connected to pump and spray gun while system is pressurized.
- Always be certain spray gun, nozzles and accessories are correctly attached.

7. Similarly, attach other end of high pressure hose to high pressure outlet (A) on pump. Pull down on collar of quick connect, slide onto pump and let go of collar. Pull on hose to be sure of tight connection.

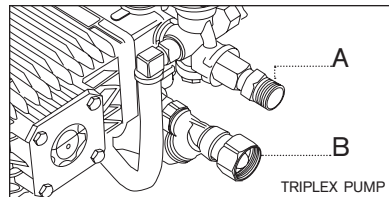
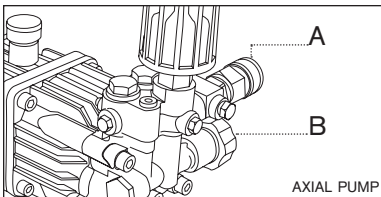



8. Turn Water Supply on, point gun in a safe direction and squeeze the trigger to purge the pump of air and debris. Do this for at least 30 seconds.
9. Take a look at all connections to make sure there are no leaks or loose connections.



**IMPORTANT: DO NOT** siphon standing water for the water supply. Use **ONLY** cold water (less than 100°F).

10. Connect the garden hose to the water inlet. Tighten by hand.

11. To start the machine, locate the ON/OFF switch on the side of the motor, and switch it to the ON position. (see component chart to locate switch)

**IMPORTANT:** Before starting the pressure washer, be sure you are wearing adequate safety goggles.

 <b>WARNING</b>	
	Risk of eye injury. Spray can splash back or propel objects.
<ul style="list-style-type: none"><li>▪ Always wear safety goggles when using this equipment or in vicinity of where equipment is in use.</li><li>▪ Before starting the pressure washer, be sure you are wearing adequate safety goggles.</li><li>▪ <b>NEVER</b> substitute safety glasses for safety goggles.</li></ul>	

 <b>WARNING</b>	
	The high pressure stream of water that this equipment produces can cut through skin and its underlying tissues, leading to serious injury and possible amputation.  Spray gun traps high water pressure, even when engine is stopped and water is disconnected, which can cause injury.
<ul style="list-style-type: none"><li>▪ <b>DO NOT</b> allow <b>CHILDREN</b> to operate pressure washer.</li><li>▪ <b>NEVER</b> repair high pressure hose. Replace it.</li><li>▪ <b>NEVER</b> repair leaking connections with sealant of any kind. Replace o-ring or seal.</li><li>▪ <b>NEVER</b> connect high pressure hose to nozzle extension.</li><li>▪ Keep high pressure hose connected to pump and spray gun while system is pressurized.</li><li>▪ <b>ALWAYS</b> point spray gun in safe direction and squeeze spray gun trigger, to release high pressure, every time you stop engine.</li><li>▪ <b>NEVER</b> aim spray gun at people, animals, or plants.</li><li>▪ <b>DO NOT</b> secure spray gun in open position.</li><li>▪ <b>DO NOT</b> leave spray gun unattended while machine is running.</li><li>▪ <b>NEVER</b> use a spray gun which does not have a trigger lock or trigger guard in place and in working order.</li><li>▪ <b>ALWAYS</b> be certain spray gun, nozzles and accessories are correctly attached.</li></ul>	



### How to Shut Down Your Pressure Washer

1. Release spray gun trigger.
2. Turn the motor switch to the OFF position.
3. ALWAYS point spray gun in a safe direction, squeeze spray gun trigger to release retained high water pressure.

**IMPORTANT:** Spray gun traps high water pressure, even when motor is stopped and water is disconnected. Couplings will not release if under pressure.

### **WARNING**



The high pressure stream of water that this equipment produces can cut through skin and its underlying tissues, leading to serious injury and possible amputation.

Spray gun traps high water pressure, even when engine is stopped and water is disconnected, which can cause injury.

- Keep high pressure hose connected to pump and spray gun while system is pressurized.
- ALWAYS point spray gun in safe direction and squeeze spray gun trigger, to release high pressure, every time you stop engine.

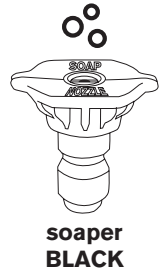
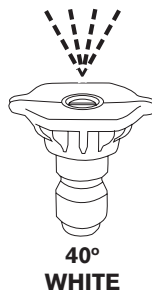
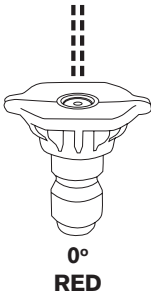

## How to Use Spray Tips

The quick-connect on the nozzle extension allows you to switch between four different quick connect spray tips. Spray tips can be changed while pressure washer is running once spray gun trigger safety lock is engaged. The spray tips vary the spray pattern as shown above.

### WARNING



The high pressure stream of water that this equipment produces can cut through skin and its underlying tissues, leading to serious injury and possible amputation.

- NEVER exchange spray tips without the trigger safety lock engaged on the spray gun.
- DO NOT twist spray tips while spraying.

## Follow these instructions to change spray tips:

1. Pull back collar on quick-connect and pull current spray tip off. Store spray tips in holder provided on the handle. Storing nozzles in the designated holder will help prevent debris clogging the tip.
2. Select desired spray tip:
  - For gentle rinse, select white 40° spray tip.
  - To scour surface, select yellow 15° or red 0° spray tip.
  - To apply detergent, select black spray tip.
3. Pull back on collar, insert new spray tip and release collar. Tug on spray tip to make sure it is securely in place.

## Usage Tips

- For most effective cleaning, keep spray tip from 8 to 24 inches away from cleaning surface.
- If you get spray tip too close, especially using a high pressure spray tip, you may damage surface being cleaned.



## USING BLACK SOAP NOZZLE

### To apply detergent, follow these steps:

1. Review use of spray tips.
2. Prepare detergent solution as required by job.
3. Place small filter end of detergent siphoning tube into detergent container.

**NOTE:** Make sure the filter is fully submerged in detergent while applying detergent.

**THIS WASHER WILL ONLY DRAW SOAP WITH THE BLACK SOAPER NOZZLE. WHITE, RED, AND YELLOW NOZZLE WILL NOT DRAW SOAP.**

4. Make sure black spray tip is installed.
5. Make sure garden hose is connected to water inlet. Check that high pressure hose is connected to spray gun and pump. Turn on water.

### NOTICE

You must attach all hoses before you start the engine.

- Starting the engine without all the hoses connected and without the water turned ON will damage the pump.
- Damage to equipment resulting from failure to follow this instruction will void warranty.

6. Start engine following instructions *Starting Your Washer*.
7. Apply detergent to surface, using long, even, overlapping strokes.
8. Allow detergent to “soak in” for 5 minutes before washing and rinsing. Reapply as needed to prevent surface from drying. **DO NOT** allow detergent to dry on.

**IMPORTANT:** You must flush the detergent siphoning system after each use by placing the filter into a bucket of clean water, then run the pressure washer in low pressure for 1-2 minutes.

### CAUTION

Chemicals can cause bodily injury and/or property damage.

- NEVER use caustic liquid with pressure washer.
- Use ONLY pressure washer safe detergent/soaps. Follow all manufacturers instructions

## Troubleshooting Chart

If you are experiencing a problem that is not listed in this chart, or have checked all the possible cause listed and you are still experiencing the problem, see your authorized dealer.

### GASOLINE ENGINES

Problem	Cause	Correction
Unit has following problems: failure to produce pressure, erratic pressure, chattering, loss of pressure, low water volume.	<ol style="list-style-type: none"> <li>1. Low pressure spray tip installed.</li> <li>2. Water inlet is blocked.</li> <li>3. Inadequate water supply.</li> <li>4. Inlet hose is kinked or leaking.</li> <li>5. Clogged inlet hose screen.</li> <li>6. Water supply is over 100°F (38°C).</li> <li>7. High pressure hose is blocked or leaks.</li> <li>8. Spray gun leaks.</li> <li>9. Spray tip is obstructed.</li> <li>10. Pump is faulty.</li> </ol>	<ol style="list-style-type: none"> <li>1. Replace with high pressure spray tip.</li> <li>2. Clear inlet.</li> <li>3. Provide adequate water flow.</li> <li>4. Straighten inlet hose, patch leak.</li> <li>5. Check and clean inlet hose screen.</li> <li>6. Provide cooler water supply.</li> <li>7. Clear blocks in outlet hose.</li> <li>8. Replace spray gun.</li> <li>9. Clean spray tip.</li> <li>10. Contact local service facility.</li> </ol>
Detergent fails to mix with spray.	<ol style="list-style-type: none"> <li>1. Detergent siphoning tube is not submerged.</li> <li>2. Detergent siphoning tube/filter is clogged or cracked.</li> <li>3. High pressure spray tip installed.</li> </ol>	<ol style="list-style-type: none"> <li>1. Insert detergent siphoning tube into detergent.</li> <li>2. Clean or replace filter/detergent siphoning tube.</li> <li>3. Replace with low pressure spray tip.</li> </ol>
Engine lacks power.	<ol style="list-style-type: none"> <li>1. Dirty air filter.</li> </ol>	<ol style="list-style-type: none"> <li>1. Replace air filter.</li> </ol>
Engine will not start	<ol style="list-style-type: none"> <li>1. Throttle lever on/off switch in OFF position</li> <li>2. No fuel in engine</li> <li>3. Worn fouled or dirty spark plug</li> <li>4. Pressure build up in pump</li> </ol>	<ol style="list-style-type: none"> <li>1. Turn throttle lever to ON position</li> <li>2. Fill fuel tank or turn on fuel supply</li> <li>3. Replace with factory recommended spark plug</li> <li>4. Squeeze trigger on spray wand (refer to operating instructions in owner's manual)</li> </ol>
Units with Oil Alert	<p>Engine not level or Engine oil level too low</p>	<p>Place engine on level surface or Fill crankcases with SAE 10W30 oil (refer to engine manufacturers instruction manual)</p>
Engine runs well at no load but "bogs" down under full load	<ol style="list-style-type: none"> <li>1. Engine speed is too slow</li> </ol>	<ol style="list-style-type: none"> <li>1. Adjust Throttle Lever back to full throttle.</li> </ol>



## TROUBLESHOOTING

Engine will not start; or starts and runs rough	<ol style="list-style-type: none"> <li>1. Low oil level</li> <li>2. Dirty air cleaner</li> <li>3. Out of gasoline</li> <li>4. Stale gasoline</li> <li>5. Spark plug wire not connected to spark plug</li> <li>6. Bad spark plug</li> <li>7. Water in gasoline</li> <li>8. Over-choking</li> </ol>	<ol style="list-style-type: none"> <li>1. Fill crankcase to proper level</li> <li>2. Clean or replace air cleaner</li> <li>3. Fill fuel tank</li> <li>4. Drain gas tank, fill with fresh fuel</li> <li>5. Connect wire to spark plug</li> <li>6. Replace spark plug</li> <li>7. Drain gas tank, fill with fresh fuel</li> <li>8. Open choke fully and crank engine</li> </ol>
Engine shuts down during operation	<ol style="list-style-type: none"> <li>1. Out of gasoline</li> <li>2. Low oil level</li> </ol>	<ol style="list-style-type: none"> <li>1. Fill fuel tank</li> <li>2. Fill crankcase with oil, to proper level</li> </ol>
Engine lacks power	<ol style="list-style-type: none"> <li>1. Dirty air filter</li> </ol>	<ol style="list-style-type: none"> <li>1. Replace air filter</li> </ol>
Engine "putts" or falters	<ol style="list-style-type: none"> <li>1. Choke is opened too soon</li> </ol>	<ol style="list-style-type: none"> <li>1. Move choke to halfway position until engine runs smoothly</li> </ol> <p>* All engine servicing to be taken to manufacturer's authorized service outlet</p>

## ELECTRIC MOTOR

Problem	Causes	Correction
Motor will not start and there is no humming sound	<ol style="list-style-type: none"> <li>1. Not plugged in</li> <li>2. "RESET" button on GFCI not pushed</li> <li>3. Circuit breaker has tripped or fuse is blown</li> </ol>	<ol style="list-style-type: none"> <li>1. Plug in</li> <li>2. Push "RESET" button</li> <li>3. Reset breaker or replace fuse</li> </ol>
Power source circuit continues to trip or blow fuses	<ol style="list-style-type: none"> <li>1. Too much load already on circuit</li> <li>2. Extension cord is too long or of improper gauge, causing voltage drop</li> <li>3. Pump is stuck due to dirt, mineral build up, or ice</li> <li>4. Motor malfunction</li> </ol>	<ol style="list-style-type: none"> <li>1. Reduce load on circuit and try another compatible amp circuit</li> <li>2. See section on extension cords</li> <li>3. Unplug unit. If temp. is below freezing do not use. Thaw in warm area.</li> <li>4. Take it to your closest Baldor dealer for servicing</li> </ol> <p>* All motor servicing to be taken to manufacturer's authorized service outlets</p>





## PUMP

Problem	Causes	Correction
No low pressure detergent delivery	<ol style="list-style-type: none"> <li>Using wrong nozzle</li> <li>Siphon hose or filter is plugged</li> </ol>	<ol style="list-style-type: none"> <li>Insert black soaper nozzle</li> <li>Unplug siphon hose</li> </ol>
Unit does not reach required pressure	<ol style="list-style-type: none"> <li>Restricted or insufficient water supply</li> <li>Unsuitable or worn out nozzle</li> <li>Regulator set too low</li> </ol>	<ol style="list-style-type: none"> <li>Check supply hose, faucet and inlet water filter. Must be connected to water source which provides 6GPM</li> <li>Replace nozzle</li> <li>Reset unloader by turning knob (clockwise increases pressure)</li> </ol>
Thermal Relief Valve is open and discharging water from side of pump	<ol style="list-style-type: none"> <li>Water temperature is too high</li> <li>Pump has operated more than 3 mins without pulling trigger</li> </ol>	<ol style="list-style-type: none"> <li>Use cool water only.</li> <li>Pull trigger at least 30 seconds every 3 mins</li> </ol>
Leak in the fittings	<ol style="list-style-type: none"> <li>Water leak in high pressure fittings, hose or gun</li> </ol>	<ol style="list-style-type: none"> <li>Use teflon tape or pipe sealant to tighten hose fitting, replace hose or gun</li> </ol> <p>**If problem continues, take to your pressure washer dealer</p>
Pump oil is low?	<ol style="list-style-type: none"> <li>Normal use consumes oil over time</li> </ol>	<ol style="list-style-type: none"> <li>To gauge the oil level, look directly into the sight glass. Oil level should always be at the center dot. Do not overfill replace w/30W non detergent mineral oil</li> </ol>
Oil is milky color	<ol style="list-style-type: none"> <li>Seals have worn from us and water has leaked in</li> </ol>	<ol style="list-style-type: none"> <li>Bring Unit local service center to have seals replaced</li> </ol>



### Winter Storage

#### NOTICE

You must protect your unit from freezing temperatures.

- Failure to do so will permanently damage your pump and render your unit inoperable.
- Freeze damage is not covered under warranty.

#### To protect the unit from freezing temperatures:

1. Use Pump Saver to treat pump. This minimizes freeze damage and lubricates pistons and seals. Contact your local dealer for Pump Saver Solution.
2. If pump saver is not available, connect a 3 ft. section of garden hose to water inlet adapter. Pour RV-antifreeze (antifreeze without alcohol) into hose. Pull recoil handle twice. Disconnect 3 ft. hose.
3. Store unit in a clean, dry area (heated area preferred).

#### Long Term Storage

If you do not plan to use the pressure washer for more than 30 days, you must prepare the engine and pump for long term storage.

#### Protect Fuel System

##### *Fuel Additive:*

Fuel will become stale when stored over 30 days. Stale fuel causes acids and gum deposits to form in the fuel system or on essential carburetor parts. Prior to storage, if gasoline has not been treated with a fuel stabilizer, it must be drained from the engine into an approved container. Then run engine until it stops from lack of fuel.

When fuel stabilizers are used according to their instructions, there is no need to drain the gasoline from the engine prior to storage. Run the engine for a short time to circulate stabilizer throughout the fuel system. Engine and fuel can then be stored up to 24 months.

If gasoline is drained, the use of a fuel stabilizer in the storage container is still recommended to maintain freshness.

#### Storing the Engine

See the engine operator's manual for instructions on how to properly prepare the engine for storage.



## NOTICE

You must protect your unit from freezing temperatures.

- Failure to do so will permanently damage your pump and render your unit inoperable.
- Freeze damage is not covered under warranty.

**NOTE:** Pump Saver is available as an optional accessory. It is not included with the pressure washer. Contact the nearest authorized dealer to purchase Pump Saver.

To use Pump Saver, make sure the pressure washer is turned off and disconnected from supply water. Read and follow all instructions and warnings given on the Pump Saver container.

### Other Storage Tips

1. DO NOT store fuel from one season to another unless it has been treated as described in Protect Fuel System.
2. Replace fuel container if it starts to rust. Rust and/or dirt in fuel can cause problems if it's used with this unit.
3. Cover unit with a suitable protective cover that does not retain moisture.

## WARNING



Storage covers can be flammable.

- DO NOT place a storage cover over a hot pressure washer.
- Let equipment cool for a sufficient time before placing the cover on the equipment.

4. Store unit in a clean and dry area.



**If you need assistance with the  
assembly or operation of this  
Pressure Washer please call**

**1-866-850-6662**