



EAGLE

GENERAL PURPOSE
UTILITY SPRAY GUN

**MODEL EGS100
OWNERS MANUAL**



www.eaglecompressor.com
1-800-551-2406

READ THE ENTIRE MANUAL BEFORE PUTTING THIS TOOL IN SERVICE

Limited Air Tool Warranty

Eagle warrants air tools of its own manufacture against defects in workmanship and materials under normal use and service for twelve(12) months from date of purchase by original purchaser. Parts are covered by this warranty for ninety(90) days from date of purchase.

The following expandable items are warranted against defects in workmanship and materials for ninety(90) days from date of purchase: sockets, screw driver bits and accessories, sanding and back-up pads, impact mechanism, chisels and their retainers, cutting and grinding accessories and any other expandable items not specifically mentioned.

Normal wear and tear, service or maintenance items such as O-rings, springs, gaskets, packing or seals, fluid needles and nozzles, motor vanes or blades, collets, chucks or any such item not specifically mentioned are covered for ninety(90) days from date of purchase warranty only.

Eagle will, at its sole discretion, repair or replace the tool or parts that have failed within the warranty period. If repairs are considered, they will be scheduled in the normal course of the workflow at its service centre.

Not covered under this warranty:

- Indirect or consequential loss or damage or expenses resulting from the failure or malfunction of this tool.
- Accidents or failures resulting from owners neglect, abuse or failure to operate and maintain the tool in accordance with the instructions provided in the owner's manual.
- Tampering, removal or alterations of safety devices will void this warranty.
- Blemishes or cosmetic defects which do not effect the tool's operation.
- Tools used industrially, commercially or in rental applications.

To claim warranty the owner/purchasers must provide proof of purchase and maintenance records, and when requested ship or deliver at owner/purchasers expense and cost to Eagle's factory or service centre

DESCRIPTION

Eagle Air tools are manufactured in accordance with our strict specifications and designed to be used in light duty professional or serious DIY applications. When used in accordance with warnings and instructions given in this manual, and when properly applied and maintained they should give you many years of productive and trouble free service.

This tool is NOT designed for professional, production or industrial use, when used in these applications its life expectancy will be significantly shortened and the warranty will be void.



Wear hearing protection.
Wear eye protection.
Wear respiratory protection.



Read the instruction manual

TABLE OF CONTENTS

Limited Warranty	2
Description.....	2
Inspection	3
Safety Instructions	3
Maintenance	4
Operation.....	4
Troubleshooting.....	5
Parts Breakdown	6
Tool Specifications.....	7

INSPECTION

Upon receipt of your new tool, carefully check for any shipping damage. If your new tool is damaged in shipping you need to file a claim with the carrier at once, and before contacting Eagle's customer service department.

Also carefully check to make sure all accessories (if included) are with the tool. Make sure any loose bolts, fittings etc. are tightened before you put this tool into service.

SAFETY INSTRUCTIONS

You should operate this air tool only if you have read this entire manual, and understand its content, and you are familiar with safety and proper use when operating this equipment. This air tool is part of a high pressure compressed air system, the following safety precautions must be followed at all times.

1)	All persons in the work area must always wear approved eye and ear protection and approved breathing apparatus when this spray gun is in operation.
2)	Never aim spray gun at anyone. Do not spray near sparks, open flame, lit cigarettes, pilot lights, space heaters or any other potential ignition source. DO NOT SMOKE IN WORK AREA.
3)	Follow manufacturers instructions and safety information to ensure safe handling and proper use of paints, lacquers, thinners, base coats, etc. Do not use latex or other heavy paints. They are not recommended for this spray gun.
4)	WARNING! Solvents trichloroethane and methylene chloride (dichloromethane - sometimes called methylchloride) can chemically react with aluminum used in most spray equipment creating an explosion hazard. Read the label or data sheet from the materials you intend to spray. NEVER USE ANY MATERIALS CONTAINING THESE SOLVENTS. If unsure as to the composition of your material, check with your supplier. Do not use acids for cleaning.
5)	Always keep work area free from obstructions and well ventilated.
6)	Always disconnect spray gun from air source before disassembly.



Wear hearing protection.
Wear eye protection.
Wear respiratory protection.

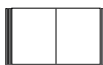

Read the instruction manual

MAINTENANCE

Clean gun before and after each use. To protect the precision machined internal parts and fittings in this gun from corrosion during shipping, some oils or other corrosion resistant agents may have been applied. It is important to remove any such residue before attempting to use the gun. To clean, place a small amount of appropriate thinner into paint cup and spray through gun while pulling and releasing trigger repeatedly. Wipe exterior of gun, nozzles and paint cup. In some cases if the gun becomes clogged, disassemble completely and soak all parts in thinner. After soaking, use a thin cleaning brush to clear small internal passages. Check and clean paint cup filter, when installed. Replace if worn.

A clean air source is imperative to ensure peak performance. The use of an in-line air filter is highly recommended to keep any contaminants from entering the spray gun.

In some painting applications proper air drying and filtration equipment may be required.

Inspect all fittings and hardware to ensure proper seating. Be sure air line fittings are tight with no leaks. Replace any worn parts as necessary.

Check needle and nozzles for nicks, scratches or burrs. Any such conditions will seriously impair performance. Replace as necessary.

OPERATION



Air and fluid volume controls: These two controls are used in conjunction with each other to accurately adjust air/fluid (Paint) ratio and will vary for different paints. Changing one control affects the other so alternating back and forth between them to fine tune your adjustment will yield optimum results

Air volume control: Air volume is adjusted by turning the air knob control. Turning knob in reduces volume, turning knob out increases volume.

Fluid volume control: Fluid volume is adjusted by turning the fluid volume control knob. Turning knob in decreases volume, turning knob out increases volume. Once a satisfactory volume is set, you can lock the adjustment by turning the lock nut in tight.



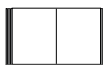

Wear hearing protection.
Wear eye protection.
Wear respiratory protection.



Read the instruction manual

TROUBLESHOOTING

Your spray gun was constructed with quality materials and workmanship and will give you many years of trouble free use when cared for and described in the maintenance section of this manual. However, as with any mechanical device periodic adjustments are necessary to maintain a peak level of performance. Should your spray gun be displaying any of the following symptoms, the simple procedures below will correct the problem.

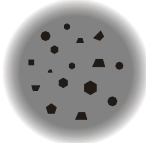
PROBLEM	CAUSE	SOLUTION
	<p>Half-Moon shaped pattern. This is usually caused by clogged air holes on the air nozzle ears.</p>	<p>Carefully clean out holes with wire after soaking in thinner</p>
	<p>Irregular or offset pattern. 1) A dirty or damaged needle tip or fluid nozzle. 2) Clogged atomization holes on air nozzle around the center.</p>	<p>1) Clean or replace needle or fluid nozzle. 2) Clean air nozzle.</p>
	<p>Spitting. 1) Too little material in cup. 2) Loose fluid nozzle. 3) Damaged needle packing. 4) Dirty or damaged needle and nozzle set.</p>	<p>1) Refill cup. 2) Tighten nozzle. 3) Replace packing. 4) Clean or replace parts.</p>
	<p>Material in cup bubbles or boils. 1) Loose, clogged or damaged fluid nozzle. 2) Loose, clogged or damaged air nozzle.</p>	<p>1) Clean, tighten or replace. 2) Clean, tighten or replace.</p>



Wear hearing protection.
Wear eye protection.
Wear respiratory protection.

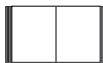

Read the instruction manual

PARTS BREAKDOWN

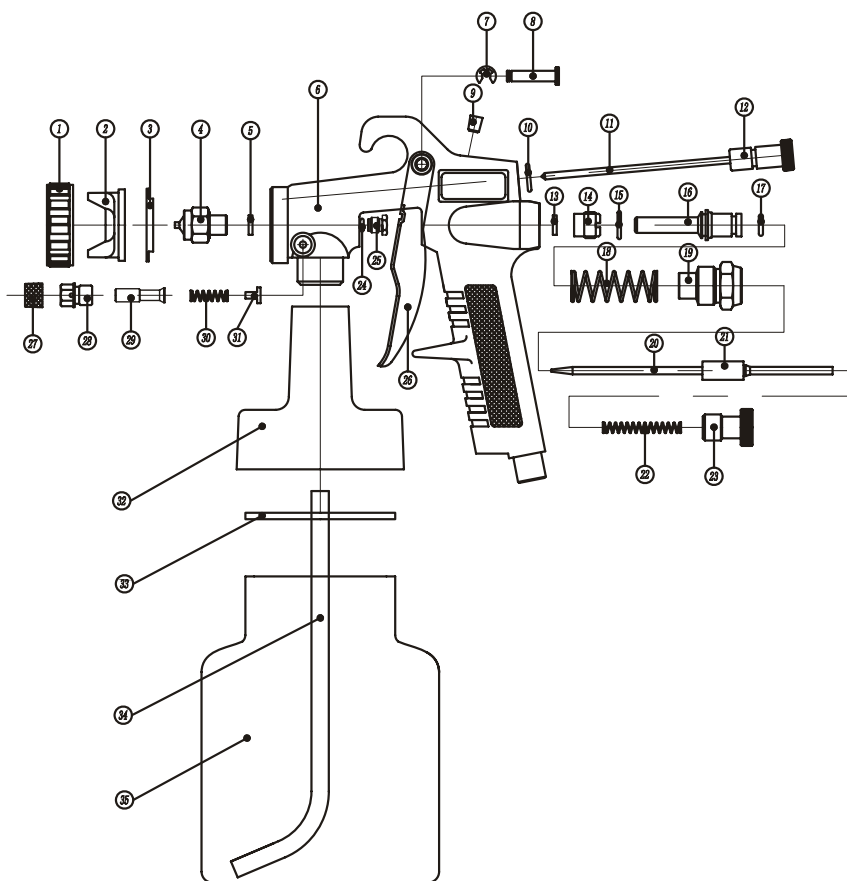

INDEX	PART	DESCRIPTION	QTY
1	29601	Cap	1
2	29602	Air Cap	1
3	29603	Air Cap Packing	1
4	29604	Nozzle	1
5	29605	Nozzle Packing	1
6	29606	Gun Body	1



Wear hearing protection.
Wear eye protection.
Wear respiratory protection.

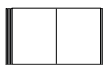

Read the instruction manual

7	29607	Stop Ring	1
8	29608	Pin	1
9	29609	Screw	1
10	29610	Sealing Packing	1
11	29611	Control Stem	1
12	29612	Control Knob	1
13	29613	Bush Packing	1
14	29614	Bushing Screw	1
15	29615	Valve O-Ring	1
16	29616	Bushing	1
17	29617	Bushing Packing	1
18	29618	Bushing Spring	1
19	29619	Nut	1
20	29620	Needle Valve	1
21	29621	Needle Socket	1
22	29622	Needle Spring	1
23	29623	Spray Regulator	1
24	29624	Valve Packing	1
25	29625	Needle Screw	1
26	29626	Trigger	1
27	29627	Function Cap	1
28	29628	Function Nut	1
29	29629	Function Screw	1
30	29630	Screw	1
31	29631	Packing	1
32	29632	Cover	1
33	29633	Cover Packing	1
34	29634	Fluid Tube	1
35	29635	Container	1

Air Pressure.....20-60 PSI
 Spray Head & Needle.....1.3 mm
 Cup Capacity.....850 ml
 Average air consumption (CFM).....8-9
 Fluid Inlet (NPT)3/8"
 Air inlet (NPT).....1/4"
 Hose size (ID).....3/8"



Wear hearing protection.
 Wear eye protection.
 Wear respiratory protection.

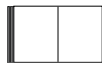

Read the instruction manual



Wood Industries, Inc.
manufactures and distributes
top of the line, high quality

**AIR COMPRESSORS
AIR COMPRESSOR PARTS
AIR POWERED ACCESSORIES**



1-800-551-2406
www.eaglecompressor.com