



EB6000 CORDLESS BLOWER (w/ battery and charger)

EB6000W CORDLESS BLOWER (w/o battery and charger)

Instruction Manual

WARNING

Some of the dust created by this product contains chemicals known to the State of California to cause cancer, birth defects or other reproductive harm.

WARNING



Users of this equipment risk injury to themselves and others if the unit is used improperly and/or safety precautions are not followed. ECHO provides an instruction manual. It must be read and understood for proper and safe operation. Failure to do so could result in serious injury.

Specifications, descriptions and illustrative material in this literature are as accurate as known at the time of publication, but are subject to change without notice. Illustrations may include optional equipment and accessories, and may not include all standard equipment.

TABLE OF CONTENTS

Table of Contents 2

Introduction 3

 The Instruction Manual 3

Servicing Information 3

 Parts/Serial Number 3

 Service 3

 Shindaiwa Consumer Product Support 3

 Warranty Registration 3

 Additional or Replacement Manuals 3

Safety 4

 IMPORTANT SAFETY INSTRUCTIONS 4

 Manual Safety Symbols and Important Information 4

 International Symbols 5

 Important Information - **Read All Instructions** 6

 Personal Condition and Safety Equipment 6

 Equipment 9

Description 13

 Safety Decals 13

Contents 14

Assembly 15

 Install Blower Pipes 15

 Remove Blower Pipes 16

 Battery Installation 17

Operation 18

 Starting Cordless Electric Blower 19

 Cruise Control 20

 Stopping Cordless Electric Blower 20

Maintenance 22

 Unit Body 22

 Battery Removal 22

 Cleaning Battery and Battery Compartment 22

 Charging Battery 22

Troubleshooting 24

Storage 25

 Electric Blower 25

 Battery 25

 Battery Charger 25

Disposal 26

 Blower 26

 Battery 26

Specifications 27

Warranty Statements 28

Notes 30

Product Registration 31

Notes 32

INTRODUCTION

Welcome to the Shindaiwa family. This Shindaiwa product was designed and manufactured to provide long life and on-the-job dependability. Read and understand this manual. You will find this manual both easy to use and full of helpful operating tips and SAFETY messages.

The Instruction Manual

Keep it in a safe place for future reference. Contains specifications and information for safety, operation, maintenance, storage, and assembly specific to this product.

SERVICING INFORMATION

Parts/Serial Number

Genuine Shindaiwa Parts and Assemblies for your Shindaiwa products are available only from an Authorized Shindaiwa Dealer. When you do need to buy parts **always** have the Model Number and Serial Number of the unit with you. You can find these numbers on the housing. For future reference, write them in the space provided below.

Model No. _____ SN. _____



Service

Service of this product during the warranty period must be performed by an authorized Shindaiwa servicing dealer. For the name and address of the authorized Shindaiwa servicing dealer nearest you, ask your retailer or call: 1-877-986-7783. Dealer information is also available on our Web Site. When presenting your unit for Warranty service/repairs, proof of purchase is required.

Shindaiwa Consumer Product Support

If you require assistance or have questions concerning the application, operation or maintenance of this product you may call the Shindaiwa Consumer Product Support Department at 1-877-986-7783 from 8:00 am to 5:00 pm (Central Standard Time) Monday through Friday. Before calling, please know the model and serial number of your unit.

Warranty Registration

To ensure trouble-free warranty coverage it is important that you register your Shindaiwa equipment on-line at www.Shindaiwa-USA.com or by filling out the warranty registration sheet in this manual. Registering your product confirms your warranty coverage and provides a direct link between you and Shindaiwa if we find it necessary to contact you.

Additional or Replacement Manuals

Replacement Instruction and Parts Catalogs are available from your authorized Shindaiwa dealer or at www.Shindaiwa-USA.com or by contacting ECHO Inc., 400 Oakwood Road, Lake Zurich, IL 60047 (1-877-986-7783). Always check the Shindaiwa Web Site for updated information.

SAFETY

IMPORTANT SAFETY INSTRUCTIONS**Manual Safety Symbols and Important Information**

Throughout this manual and on the product itself, you will find safety alerts and helpful, informational messages preceded by symbols or key words. The following is an explanation of those symbols and key words and what they mean to you.

 **DANGER**

The safety alert symbol accompanied by the word “DANGER” calls attention to an act or condition which WILL lead to serious personal injury or death if not avoided.

 **WARNING**

The safety alert symbol accompanied by the word “WARNING” calls attention to an act or condition which CAN lead to serious personal injury or death if not avoided.

 **CAUTION**

The safety alert symbol accompanied by the word “CAUTION” calls attention to an act or condition which may lead to minor or moderate personal injury if not avoided.

 **NOTICE**













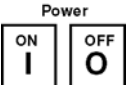









The enclosed message provides information necessary for the protection of the unit.

Note: This enclosed message provides tips for use, care and maintenance of the unit.

**CIRCLE AND SLASH SYMBOL**

This symbol means the specific action shown is prohibited. Ignoring these prohibitions can result in serious or fatal injury.

International Symbols

Symbol	Description	Symbol	Description	Symbol	Description	Symbol	Description
	Read Instruction Manual		Wear slip resistant footwear		Fire Hazard, Risk of Explosion or Burns		Power ON / OFF
	Wear Head, Eye, and Hearing Protection		Finger Sever Hazard		Check Charger's Power Supply and Plug for Damage		Do not operate without blower tubes in place
	Wear Hand and Foot Protection		DO NOT Use in Rain; Protect from Fluids		Remove Battery from Blower When Not in Use		Recycle Battery at an accredited RBRC recycling center
	Safety Alert Symbol		DO NOT Throw Electrical Appliances in Garbage		Slow Speed		Fast Speed
	Burn Hazard Alert		DO NOT Subject Battery to Temperatures Above 140°F (60°C)		Recycle Electrical Appliances		Failure to keep long hair away from the air inlet could result in personal injury
		Keep bystanders and helpers away 15 m (50 ft.).			Failure to keep loose clothing from being drawn into air intake could result in personal injury		Thrown objects can ricochet and result in personal injury or property damage

Important Information - Read All Instructions

WARNING

When using unit, basic safety precautions should always be followed to reduce the risk of fire, electric shock, and personal injury.

- *Before assembling, operating, or servicing your unit, you must read and understand this Instruction Manual.*
- *You must understand all safety symbols and warning labels, and obey the safety precautions provided by these important safety reminders.*
- *You must be alert at all times, and be physically capable of handling and controlling the blower in a variety of applications.*
- *If you are unable to handle the equipment safely, or if you feel that the task you wish to perform could put you, your property, or others at risk, please call a professional landscape maintenance company to handle the job.*
- *Know your blower. Read instruction manual carefully. Learn its applications and limitations, as well as the specific potential hazards related to this blower. Following this rule will reduce the risk of electric shock, fire, or serious injury.*
- *Keep work area clean and well lit. Cluttered or dark areas invite accidents.*
- *Do not permit children to use blower. It is not a toy. Close attention is necessary when used near children.*
- *Do not operate blowers in explosive atmospheres, such as in the presence of flammable liquids, gases, or dust. Blowers create sparks which may ignite the dust or fumes.*

SAVE THESE INSTRUCTIONS

Personal Condition and Safety Equipment

WARNING

Users of this product risk injury to themselves and others if the unit is used improperly and/or safety precautions are not followed. Proper clothing and safety gear must be worn when operating unit.

Physical Condition

Your judgment and physical dexterity may not be good:

- If you are tired or sick.
- If you are taking medication.
- If you have taken alcohol or drugs.

Operate unit only if you are physically and mentally well.

Eye Protection

WARNING

- Eye protection that meets ANSI Z87.1 or CE requirements must be worn whenever you operate the unit.
- For additional safety, a full-face shield may be worn over safety glasses or goggles to provide protection from sharp branches or flying debris.

Hand Protection

Wear sturdy, no-slip, rubber work gloves to improve your grip on the handles. Gloves also provide protection against cuts and scratches, cold environments, and reduce the transmission of machine vibration to your hands.

Hearing/Ear Protection

ECHO recommends wearing hearing protection whenever unit is used.

Breathing Protection

Operators who are sensitive to dust or other common airborne allergens may need to wear a dust mask to prevent inhaling these materials while operating unit. Dust masks can provide protection against dust, plant debris, and other plant matter such as pollen. Make sure the mask does not impair your vision, and replace the mask as needed to prevent air restrictions.

Proper Clothing

Wear snug-fitting, durable clothing:

- Pants should have long legs, shirts should have long sleeves.
- DO NOT WEAR SHORTS.
- DO NOT WEAR TIES, SCARVES, JEWELRY, or clothing with loose or hanging items that could become entangled in moving parts or surrounding growth.
- Keep clothing buttoned or zipped, and keep shirt tails tucked in.

Wear sturdy work shoes with nonskid rubber soles:

- DO NOT WEAR OPEN TOED SHOES.
- DO NOT OPERATE UNIT BAREFOOTED.

Keep long hair away from moving parts. Retain hair with cap or net.

Heavy protective clothing can increase operator fatigue, which may lead to heat stroke. Schedule heavy work for early morning or late afternoon hours when temperatures are cooler.

WARNING

The components of this machine generate an electromagnetic field during operation, which may interfere with some pacemakers. To reduce the risk of serious or fatal injury, persons with pacemakers should consult with their physician and the pacemaker manufacturer before operating this machine. In the absence of such information, ECHO does not recommend the use of Shindaiwa products by anyone who has a pacemaker.

Extended Operation / Extreme Conditions

CAUTION

Prolonged exposure to cold and/or vibration may result in injury. Read and follow all safety and operation instructions to minimize risk of injury. Failure to follow instructions may result in painful wrist/hand/arm injuries.

It is believed that a condition called Raynaud's Phenomenon, which affects the fingers of certain individuals, may be brought about by exposure to vibration and cold. Exposure to vibration and cold may cause tingling and burning sensations, followed by loss of color and numbness in the fingers. The following precautions are strongly recommended, because the minimum exposure, which might trigger the ailment, is unknown.

- Keep your body warm, especially the head, neck, feet, ankles, hands, and wrists.
- Maintain good blood circulation by performing vigorous arm exercises during frequent work breaks, and also by not smoking.
- Limit the hours of operation. Try to fill each day with jobs where operating the unit or other hand-held power equipment is not required.
- If you experience discomfort, redness, and swelling of the fingers followed by whitening and loss of feeling, consult your physician before further exposing yourself to cold and vibration.



Repetitive Stress Injuries (RSI)

It is believed that overusing the muscles and tendons of the fingers, hands, arms, and shoulders may cause soreness, swelling, numbness, weakness, and extreme pain in those areas. Certain repetitive hand activities may put you at a high risk for developing a Repetitive Stress Injury (RSI). An extreme RSI condition is Carpal Tunnel Syndrome (CTS), which could occur when your wrist swells and squeezes a vital nerve that runs through the area. Some believe that prolonged exposure to vibration may contribute to CTS. CTS can cause severe pain for months or even years.

To reduce the risk of RSI/CTS, do the following:

- Avoid using your wrist in a bent, extended, or twisted position. Instead try to maintain a straight wrist position. Also, when grasping, use your whole hand, not just the thumb and index finger.
- Take periodic breaks to minimize repetition and rest your hands.
- Reduce the speed and force with which you do the repetitive movement.
- Do exercise to strengthen the hand and arm muscles.
- Immediately stop using all power equipment and consult a doctor if you feel tingling, numbness, or pain in the fingers, hands, wrists, or arms. The sooner RSI/CTS is diagnosed, the more likely permanent nerve and muscle damage can be prevented.

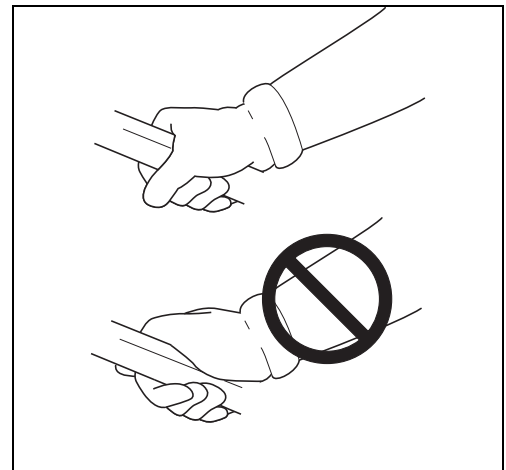

! DANGER

All over head electrical conductors and communications wires can have electricity flow with high voltages. This unit is not insulated against electrical current. Never touch wires directly or indirectly, otherwise serious injury or death may result.

Read the Manual

Provide all users of this equipment with the Instruction Manual for instructions on safe operation.

Keep a Firm Grip

Hold the handle in one hand with thumb and fingers tightly encircling the handle.

Keep a Solid Stance

Maintain footing and balance at all times. DO NOT stand on slippery, uneven, or unstable surfaces. DO NOT work in odd positions or on ladders. DO NOT over reach.

Avoid Hot Surfaces

Avoid contact during and immediately after operation.

**Equipment****NOTICE**

Avoid unnecessary impact and abusive treatment. Unit contains electronic components.

! WARNING

- *Avoid Dangerous Environment – DO NOT use unit in damp or wet locations.*
- *DO NOT use unit in the rain.*

! WARNING

Keep Children Away – All visitors should be kept at a distance from work area.

! WARNING

Use Correct Unit – Use unit only for its intended purpose.

! WARNING

Use only SHINDAIWA attachments. Serious injury may result from the use of a non-approved attachment combination. ECHO, INC. will not be responsible for the failure of attachments, or accessories which have not been tested and approved by ECHO. Read and comply with all safety instructions listed in this manual.

⚠ WARNING

- **Moving parts can amputate fingers or cause severe injuries. Keep hands, clothing, and loose objects away from all openings.**
- **ALWAYS turn power to unit off, remove battery, and make sure all moving parts have come to a complete stop before removing obstructions, clearing debris, cleaning, or servicing unit.**
- **Do not put any object into openings. Do not use with any opening blocked; keep free of dust, lint, hair, and anything that may reduce air flow.**
- **Avoid Unintentional Starting – DO NOT carry unit with the power indicator LED illuminated. Be sure power indicator LED is off when carrying the unit.**
- **Store Idle Unit Indoors – When not in use, units should be stored indoors in a dry, and high or locked-up place – out of reach of children.**
- **Do not hang unit so that the throttle trigger is depressed.**
- **Do not operate unit unless all guards and protective covers are properly assembled to unit.**

⚠ WARNING

- **Check unit for damage, especially if the unit is dropped. If damage is found, do not use unit, otherwise serious personal injury or property damage may occur. Have unit repaired by an authorized servicing dealer before using.**
- **Check unit for loose/missing nuts, bolts, and screws. Tighten and/or replace as needed.**
- **Do not use blower if any part is missing or damaged.**
- **Keep handle dry and clean.**

Battery**⚠ DANGER**

- **For use only with part numbers 99945600300 or 99945600301 chargers. Risk of fire and burns. Do not open, crush, heat above 60 °C (140° F) or incinerate. Follow all safety instructions.**
- **DO NOT charge or use a defective, damaged or deformed battery. Do not open, damage, or drop the battery. Released electrolyte is corrosive and may cause damage and severe chemical burns to the eyes or skin. It may be toxic if swallowed. In the event of accidental contact, wash the affected areas of skin with plenty of water and soap. If fluid gets in the eyes, do not rub. Rinse the eyes with plenty of water for at least 15 minutes and seek medical assistance.**
- **Exercise care in handling batteries in order not to short the battery with conducting materials such as rings, bracelets, and keys. The battery or conductor may overheat and cause burns.**
- **DO NOT dispose of the battery in a fire. The cell may explode. Check with local codes for possible special disposal instructions, or recycle the battery at an accredited Rechargeable Battery Recycling Corporation recycling center.**
- **Avoid direct sunlight, heat and open flames.**
- **DO NOT allow battery to get wet.**
- **CHARGE battery only in proper temperature range of 0°C to 60°C (32°F to 140°F).**

- **DO NOT solder on battery pack.**
- **DO NOT reverse battery polarity or terminals.**
- **DO NOT reverse charge or reverse connect battery.**
- **Connect battery only to correct Shindaiwa charger.**
- **Use battery only with intended unit.**

WARNING

- **Do not use battery in conjunction with other battery types.**
- **Keep battery out of reach of children.**
- **Charge battery only according to instructions in this manual.**
- **DO NOT expose battery to microwaves or high pressure.**
- **DO NOT charge appliance in rain or in wet locations.**
- **Use only the correct Shindaiwa type and size battery for this unit.**
- **Remove battery from unit before transporting or storing unit.**
- **When battery pack is not in use, keep it away from other metal objects like: paper clips, coins, keys, nails, screws, or other small metal objects that can make a connection from one terminal to another. Shorting the battery terminals together may cause sparks, burns, or a fire.**
- **Keep battery and battery compartment clear of flammable debris.**

Battery Charger

DANGER

TO REDUCE THE RISK OF FIRE OR ELECTRICAL SHOCK CAREFULLY FOLLOW THESE INSTRUCTIONS.

WARNING

- **This manual contains important safety and operating instructions for battery charger Model 99945600300 or 99945600301.**
- **Before using battery charger, read all instructions and cautionary markings on battery charger, battery, and product using battery.**
- **To reduce risk of injury, charge only SHINDAIWA lithium-ion rechargeable battery Model 99945600200 or 99945600201. Other types of batteries may burst causing personal injury and damage**
- **Never use a defective or damaged charger**
- **Do not open the charger.**
- **Do not cover the charger. Covering the charger will prevent it from cooling.**
- **In the event of smoke or fire in the charger, disconnect it from the wall outlet immediately.**
- **Do not operate on an easily combustible surface (e.g. paper, textiles) or in an easily combustible environment - there is a risk of a fire.**

- *Do not operate the charger in explosive atmospheres, such as in the presence of flammable liquids, gases or dust. Chargers can produce sparks which may ignite the dust or fumes - there is a risk of explosion.*
- *Charger plugs must match the outlet. Never modify the plug in any way. Do not use any adapter plugs with earthed (grounded) chargers. Unmodified plugs and matching outlets will reduce risk of electric shock.*
- *Check the charger's connecting cord regularly for damage. If the connecting cord is damaged, immediately disconnect the plug from the power supply to avoid the risk of electric shock.*
- *To unplug, grasp the plug, not the cord.*
- *Do not use the connecting cord for any other purpose, e.g. for carrying or hanging up the charger.*
- *Do not abuse the connecting cord. Keep cord away from heat, oil, sharp edges or moving parts.*
- *To reduce the risk of stumbling, position and mark the connecting cord in such a way that it cannot be damaged or endanger others.*
- *To reduce the risk of electric shock, always connect the charger to a properly installed wall outlet.*
- *Do not handle charger, including charger plug, and charger terminals with wet hands.*
- *Do not charge the unit outdoors.*

SAVE THESE INSTRUCTIONS

DESCRIPTION

Safety Decals

Locate these safety decals on your unit. Make sure the decals are legible and that you understand and follow the instructions on them. If a decal cannot be read, a new one can be ordered from your authorized Shindaiwa dealer. See SERVICING INFORMATION for details.

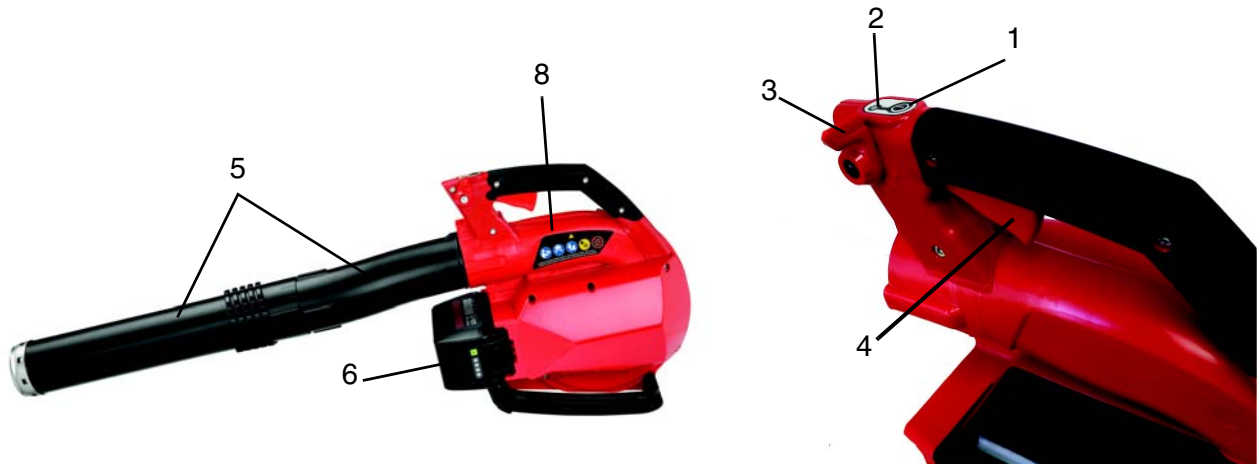

Battery usage decal



General Warning Decal



1. **POWER BUTTON** - Press once to turn on power to the unit, power indicator LED illuminates. Press once more to turn power off to unit, power indicator LED turns off.
2. **POWER INDICATOR LED** - Remains illuminated when power to unit is turned on. Turns off when power to unit is off.
3. **CRUISE CONTROL LEVER** - Pull back to increase blower speed.
4. **THROTTLE TRIGGER** - Spring loaded to return to stop when released.
5. **BLOWER PIPES** - Exclusive positive locking system.
6. **BATTERY.**
7. **AIR INLET.**
8. **GENERAL WARNING DECAL.**
9. **BATTERY USAGE DECAL**

CONTENTS

The Shindaiwa product you purchased has been factory pre-assembled for your convenience. Due to packaging restrictions, some assembly may be necessary.

After opening the carton, check for damage. Immediately notify your retailer or Shindaiwa Dealer of damaged or missing parts. Use the contents list to check for missing parts.

Battery and charger may be sold separately.

- __1__ - 1, Blower Assembly
- __2__ - 1, Blower Pipe (upper)
- __3__ - 1, Blower Pipe (lower)
- __4__ - 1, Instruction Manual
- __5__ - 1, Battery (EB6000 model only)
- __6__ - 1, Battery Charger (EB6000 model only)

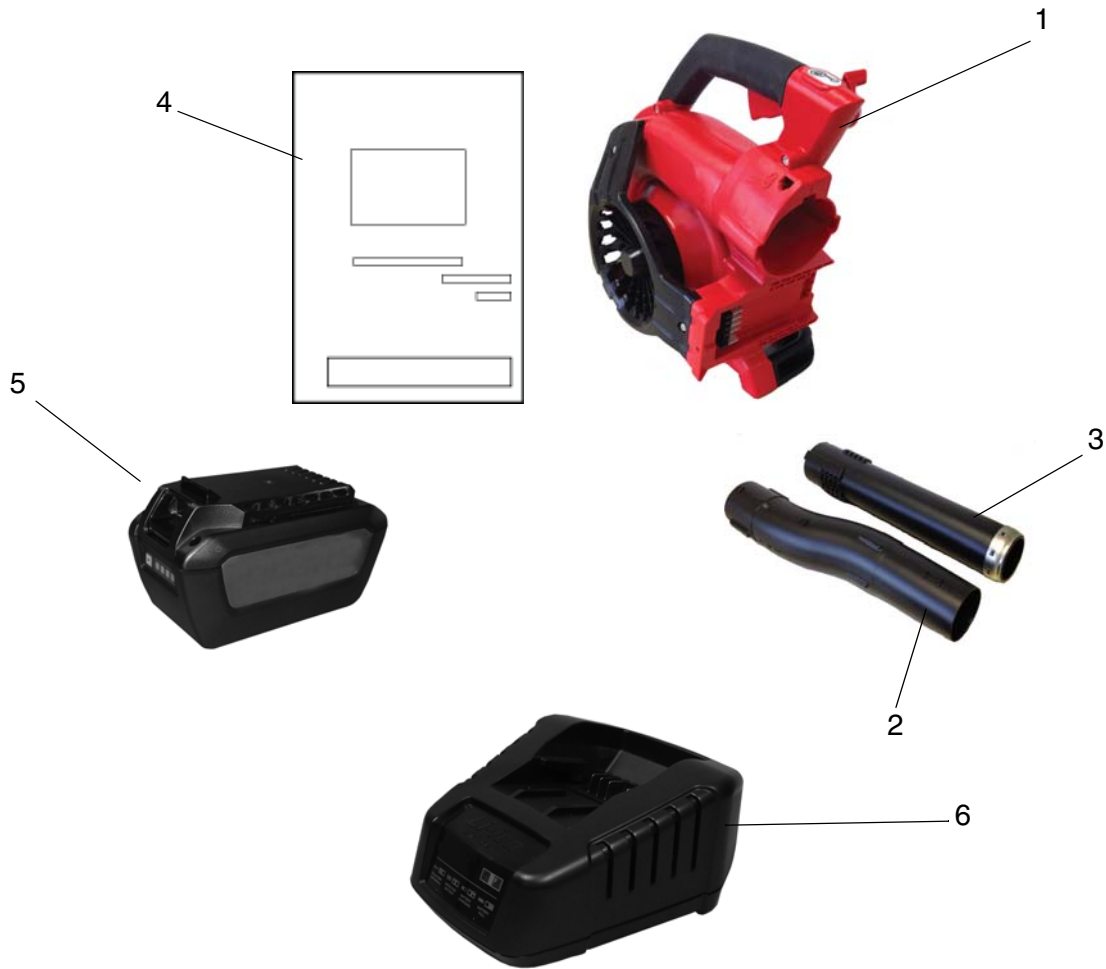

ASSEMBLY

WARNING

To prevent accidental starting that could cause serious personal injury, always remove the battery pack from the tool when assembling parts. If any parts are damaged or missing do not operate this product until the parts are replaced. Use of this product with damaged or missing parts could result in serious personal injury. Do not attempt to modify this product or create accessories not recommended for use with this blower. Any such alteration or modification is misuse and could result in a hazardous condition leading to possible serious personal injury.

Install Blower Pipes

1. Stand unit upright on blower base.
2. Align locking ribs (A) on upper blower pipe with recesses (B) in fan case. Assure short locking rib (C) faces upward. Slide upper blower pipe into fan case until a clicking sound is heard.

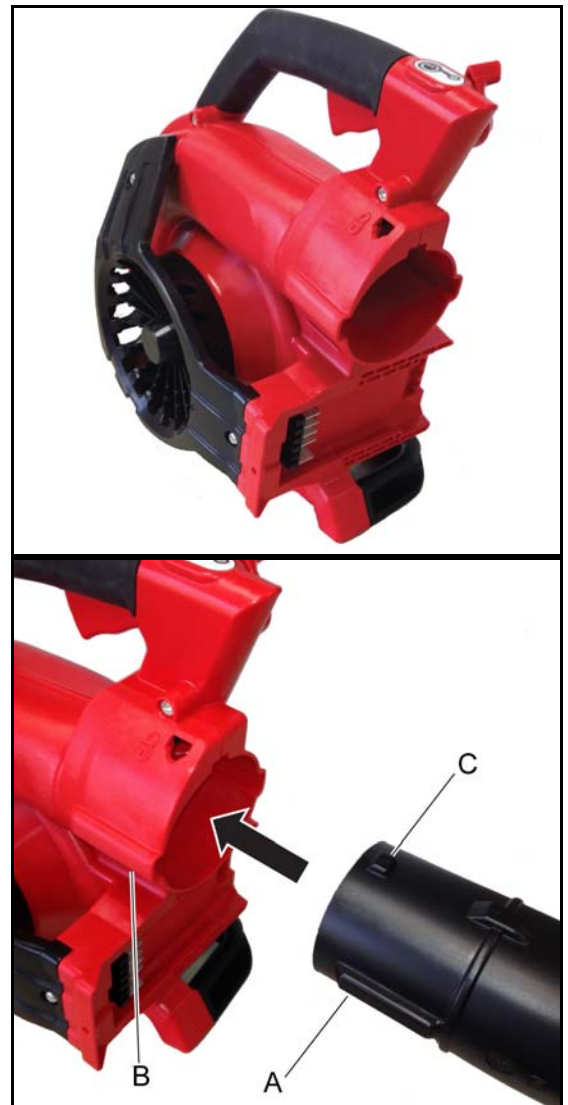

3. Align tabs (D) with grooves (E) and slide lower blower pipe over upper pipe until there is light resistance. Do not force connection.
4. Hold upper pipe (F), and turn lower pipe (G) clockwise, engaging positive locking channels until connection is firm. Do not force connection.

Note: Blower use will eventually loosen pipe connections. Exclusive positive locking system allows pipes to be tightened. If loosening occurs, remove lower straight pipe, and install according to instructions 3 & 4.

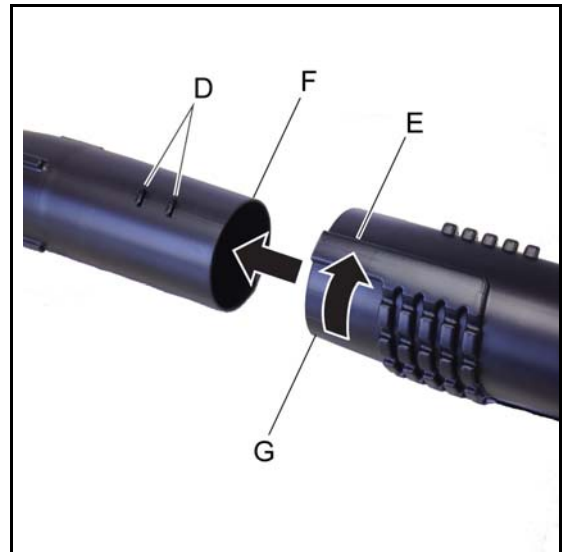

Remove Blower Pipes

1. Insert screwdriver (H) into hole located near lock symbol (I) to release pipe lock.



2. Pull pipe out of fan case.
3. Remove screwdriver.



Battery Installation

WARNING

The blower will operate when the battery is installed, the power indicator LED is lit, and the throttle trigger or cruise control are engaged. Make sure the blower is properly positioned to prevent loss of control and possible serious injury.

Note: The battery comes partially charged from the factory and needs to be fully charged before first use.

1. Make sure power to unit is turned off.

Note: *Unit may be shipped with battery attached to blower with battery spacer. Remove screw (D), and remove battery spacer (E) for initial battery installation.*

2. Align ridges (A) on battery pack with grooves in blower. Slide battery pack into blower.

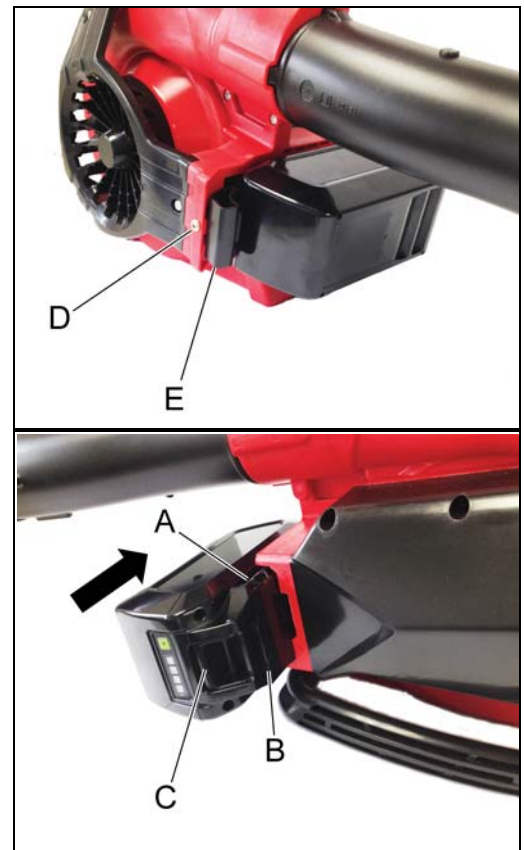

NOTICE

Assure the battery pack latch (B) snaps into place and battery pack is secure before beginning operation.

3. To remove battery, depress battery pack latch release (C) slide battery pack out of blower.

OPERATION

⚠ WARNING

Moving parts can amputate fingers or cause severe injuries. Keep hands, clothing, and loose objects away from all openings. ALWAYS turn power to unit off, remove battery, and make sure all moving parts have come to a complete stop before removing obstructions, clearing debris, cleaning, or servicing unit.

⚠ WARNING

Careless operation, misuse, improper configuration or assembly, or use of unapproved attachments can result in serious or fatal injuries to operator and bystanders. Flying debris can cause serious eye injury, loss of sight, or property damage. You must read, understand, and follow all safety and operating instructions in this manual.

- ***ALWAYS wear safety glasses, hearing protection and face filter mask or serious injury may result. Do not point the blower pipe in the direction of people or pets.***
- ***ALWAYS maintain a minimum safety zone of 50 feet (15 meters) from where you are working. Don't allow others to enter the safety zone unless you have shut the unit off and the blower has completely stopped moving.***
- ***Check the work area before each use. Remove all objects such as rocks, broken glass, nails, wire, or string which can be thrown or become entangled in the machine.***
- ***NEVER work in the dark or when visibility of the work area is poor.***
- ***ALWAYS be alert for changes in operation that could signal a problem - sudden vibration and unusual noise require immediate attention. Stop the unit and correct any problems before resuming operation.***
- ***ALWAYS switch off the unit and remove the battery when transporting the unit.***
- ***NEVER use blower near fires, fireplaces, hot ashes, barbecue pits, etc. Use near fires or ashes can spread fires and result in serious injury and/or property damage.***
- ***NEVER use blower to spread chemicals, fertilizers, or any other toxic substances. Spreading these substances could result in serious injury to the operator or bystanders.***
- ***NEVER place blower on any surface, except a hard, clean surface when motor is running. Gravel, sand, and other debris can be picked up by the air inlet and thrown at the operator or bystanders, causing possible serious injuries.***

NOTICE

To avoid motor damage, do not block blower pipe.

1. Use only during appropriate hours. Contact your local government for the ordinances affecting your area.
2. To reduce sound levels, limit the number of pieces of equipment used at any one time.

3. Control speed with throttle trigger (D), or for continuous use, set speed with cruise control (C).
4. Use lower speed to blow dry leaves from walks, patios and drives. Use rakes and brooms to loosen debris before blowing.
5. Additional speed may be necessary to clean grass and leaves from a lawn or flower bed.

Note: Never use a higher speed setting than necessary to perform a task. Remember, the higher the speed, the louder the blower noise.

6. Use the full blower pipe configuration when blowing.
7. After using blowers and other equipment, CLEAN UP! Dispose of debris in trash receptacles.

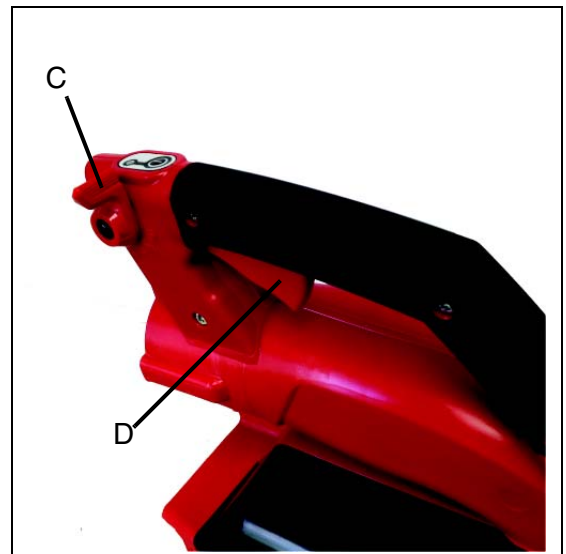

CAUTION

Contacting blower pipe tip on abrasive surfaces can create sharp cutting edges and can result in personal injury if touched. Do not scrape or drag blower pipe tip when operating or transporting unit. Replace blower pipe assembly if protective metal ring is worn, cracked or deformed.

Starting Cordless Electric Blower

WARNING

The blower will operate when the battery is installed, the power indicator LED is lit, and the trigger and trigger or cruise control are engaged. Make sure the blower is properly positioned to prevent loss of control and possible serious injury.

1. Push power button (A) once to turn on power to unit.
Note: Power indicator LED (B) illuminates when power to unit is turned on.
2. Squeeze throttle trigger (D) to increase RPM to operating speed.

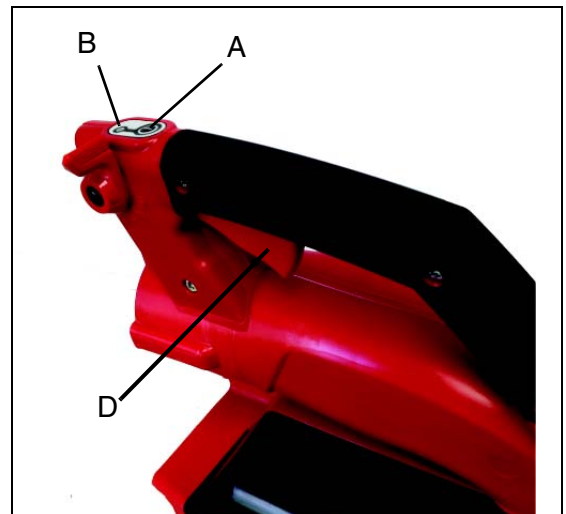

Cruise Control

⚠ WARNING

Before connecting a battery pack to the blower, always move the cruise control lever completely forward to the stop position. Failure to ensure that it is in the stop position could result in accidental starting of the blower and serious injury. Do not lock the throttle trigger in applications where the blower may need to be suddenly stopped.

1. Squeeze the throttle trigger (D).
2. Move the cruise control lever (C) towards the rear of the blower and into either the STOP (1), LOW (2), MEDIUM (3), HIGH (4) or MAXIMUM (5) speed position.
3. Release throttle trigger (D) and blower will remain running at selected speed.
4. To stop the blower, move cruise control lever (C) completely forward (Stop position).

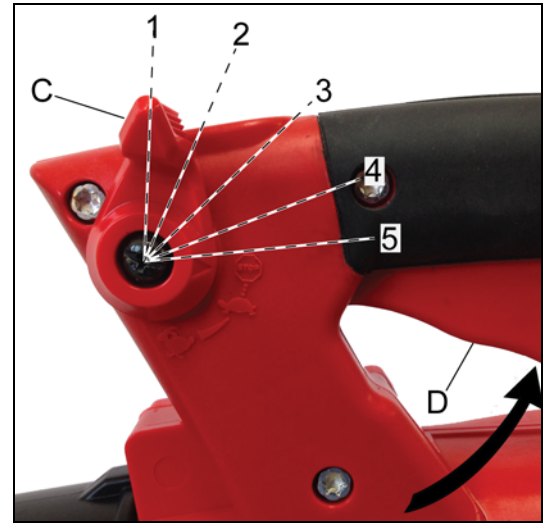

Note: If the cruise control feature is engaged during use and the battery pack is removed from the tool, disengage the cruise control feature immediately.

Stopping Cordless Electric Blower

⚠ WARNING

The blower continues to run for a short period after the unit is switched off.

1. Release throttle trigger (D) and move the cruise control lever (C) completely forward (Stop position), and allow blower to stop.
2. Push power button (A) to turn off power to unit.

Note: Power indicator LED (B) turns off when power to unit is turned off.

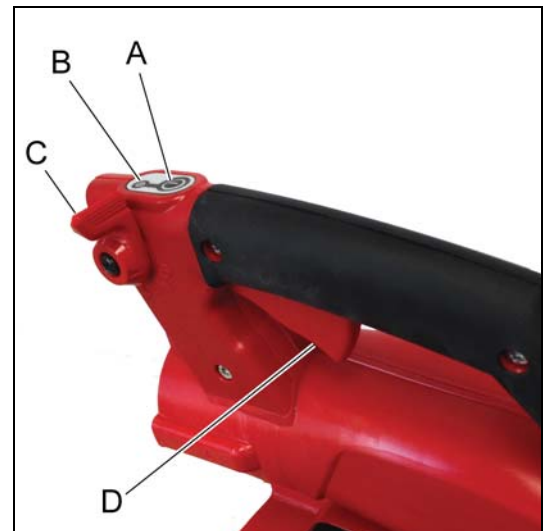

⚠ WARNING

If the power button does not stop the blower, remove the battery to stop the power supply to blower. Have your authorized Shindaiwa servicing dealer repair power button before using blower again. If the blower does not stop when the trigger is released and the cruise control lever is moved completely forward (Stop position), remove the battery to stop the power supply to blower. Have your authorized Shindaiwa servicing dealer repair unit before using again.

NOTICE

When power to the unit is turned on:

- After ONE minute of inactivity, unit will power itself off.
- If the LED remains lit, operation is normal.
- If the LED flashes once per second, the battery needs to be charged.
- If the LED flashes four times per second, there is a fault within the blower. Turn power off to unit. Remove battery. Clear debris from around the air inlet. Install battery. Turn power on to unit. If flashing continues, have your authorized Shindaiwa servicing dealer repair the blower.

MAINTENANCE

⚠ WARNING

- **Moving parts can amputate fingers or cause severe injuries. Keep hands, clothing, and loose objects away from all openings. ALWAYS turn power to unit off, remove battery, and make sure all moving parts have come to a complete stop before removing obstructions, clearing debris, cleaning, or servicing unit. Allow unit to cool before performing service. Wear gloves to protect hands from sharp edges and hot surfaces.**
- **Blower service must be performed only by qualified repair personnel. Service or maintenance performed by unqualified personnel may result in risk of injury.**

Your Shindaiwa blower is designed to provide many hours of trouble-free service. Regular scheduled maintenance will help your blower achieve that goal. If you are unsure or are not equipped with the necessary tools, you may want to take your unit to your authorized Shindaiwa servicing dealer for maintenance.

Unit Body

1. Check unit for loose/missing nuts, bolts, and screws once per month. Tighten and/or replace as needed.
2. Use compressed air or a soft bristle brush to remove debris from unit body.

Battery Removal

1. Release throttle trigger and move cruise control lever completely forward (Stop position) and allow blower to stop.
2. Make sure power indicator LED is not illuminated.
3. Depress battery pack latch release (C) slide battery pack out of blower.



Cleaning Battery and Battery Compartment

1. Remove battery and use compressed air or a soft bristle brush to remove debris from battery and battery compartment once per week.

⚠ WARNING

Risk of electric shock or fire. Do not use conducting materials to clean battery or battery compartment.

Charging Battery

⚠ WARNING

- **Keep charger and battery away from damp conditions and all liquids.**
- **Connect the charger only to 120V AC outlet.**

- **Never insert objects in the battery pack's or charger's cooling slots (A).**

Note: The battery comes partially charged from the factory and needs to be fully charged before first use.

Note: Charge the battery when it no longer produces sufficient power to operate the blower or when battery lights indicate that the battery is low.

1. Plug charger AC cord into 120V AC outlet.
2. Align ridges on battery with grooves on charger, and slide battery into charger.
3. During normal charging, the charger LED (B) will blink continuously GREEN.

NOTICE

If charger detects a problem, LED blinks RED. Remove battery from charger, clear obstructions from contacts and reinstall battery into charger. If battery is outside acceptable temperature range (0°C to 60°C or 32°F to 140°F) LED remains RED.

4. When charging is complete, LED will remain GREEN.

Note: A fully discharged battery pack will charge in about 150 minutes.

5. Verify battery is fully charged by removing battery from charger, then pressing battery charge status button (C), and checking LED display (D).
 - 1 green light indicates that the battery has 0-25% charge.
 - 2 green lights indicate that the battery has 25-50% charge.
 - 3 green lights indicate that the battery has 50-75% charge.
 - 4 green lights indicate that the battery has 75-100% charge.
6. Disconnect battery charger from power supply.

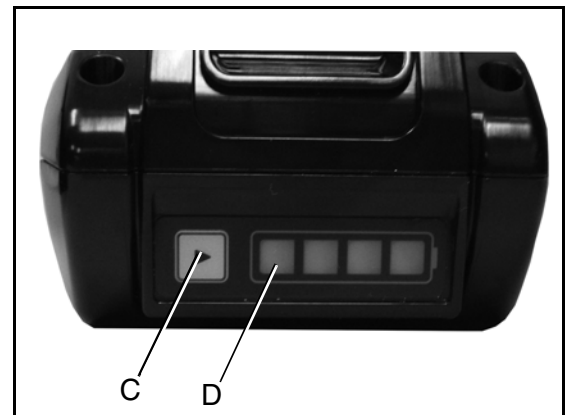

TROUBLESHOOTING

Trouble	Cause	Remedy
Red Charger light flashes or does not light up	-Plug not connected to power outlet	-Plug in the charger
	-Battery pack not installed properly	-Check the battery pack installation
	-Obstructed connection	-Reinstall battery pack again after removing obstructions from connection.
	-Fault in the charger	-Ask your Shindaiwa dealer
	-Fault in the battery pack	
Unit will not turn on	-Battery pack not installed properly	-Check the battery pack installation
Unit does not run when turned on	-Battery pack discharged	-Charge the battery pack
	-Battery pack outside acceptable temperature range	-Remove the battery pack and allow to cool
Running time is too short	-Battery pack outside acceptable temperature range	-Remove the battery pack and allow to cool
	-Unit electronics too hot	-Turn unit off and allow to cool
	-Battery pack discharged	-Charge the battery pack
Unit runs, but doesn't blow or is weak	-Blower pipe clogged	-Unclog pipe
	- Blower pipe loose	- Tighten pipe
	- Blower pipe damaged	- Replace pipe
	-Air inlet clogged	- Unclog air inlet
Unit runs, air output is low	-Fault in the fan	-Ask your Shindaiwa dealer
Unit vibrates excessively	-Fault in internal parts	-Ask your Shindaiwa dealer

STORAGE

WARNING

Do not store in an enclosure where combustible fumes may accumulate.

Electric Blower

Do not store your unit without performing protective storage maintenance which includes the following:

1. Turn power to unit off.
2. Remove battery from blower. See Battery Removal.
3. Remove accumulation of dirt and debris from exterior of unit.
4. Tighten all screws and nuts.
5. Cover battery compartment of blower.
6. Store unit in a dry, dust-free place, out of the reach of children.

Battery

1. Remove battery from blower. See Battery Removal.
2. Store in a dry, dust-free place, out of the reach of children.
3. Store in temperatures between -0°C (32°F) and 40°C (104°F).
4. If battery is stored for longer than one year, charge it to approximately 40 - 60% capacity (see “Charging Battery” section).

Battery Charger

1. Remove battery from battery charger.
2. Disconnect battery charger from power supply.
3. Store in a dry, dust-free place, out of the reach of children.

DISPOSAL

Blower

Major plastic parts making up the product have codes showing their materials. The codes refer to the following materials; dispose of those plastic parts in accordance with local regulations.

Mark	Material
>PA6-GF<	Nylon 6 - Glass fiber
>PP-GF<	Polypropylene - Glass fiber
>PE-HD<	Polyethylene
>PP<	Polypropylene

Battery

ECHO, Incorporated, participates in the Rechargeable Battery Recycling Corporation (RBRC) program.

ECHO has prepaid so that our customers can responsibly dispose of batteries. PLEASE DO NOT throw battery away in garbage. Please recycle the battery at an accredited RBRC recycling center. Visit www.call2recycle.org, or call 1-800-822-8831 to find a recycling center near you.

SPECIFICATIONS

MODEL	EB6000, EB6000W
Length	954mm (37.6 in) with pipes / 353mm (13.9 in) w/o pipes
Width	187mm (7.4 in)
Height	336mm (13.2 in)
Weight w/Battery	5.0 kg (11.0 lb)
Battery Type	Li-ion
Battery Pack Voltage	56 Volts (rated 50.4 V)
Battery Charger Type	CCCV
Battery Charger Input Voltage	110–120 Volts
Battery Charger Lights	<p>Red LED – Battery is outside charging temperature range</p> <p>Red LED Blinking – Fault</p> <p>Green LED – Battery finished charging</p> <p>Green LED Blinking-- Battery is charging normally</p>
Charge Time	99945600200 battery: Approximately 72 min. 99945600201 battery: Approximately 150 minutes.
Average Air Speed w/pipes	60.2 m/sec (135 mph)
Maximum Air Speed w/ pipes	72.5 m/sec (162 mph)
Air Volume w/ pipes	10.8 m ³ /min. (381 cu.ft./min.)
Minimum motor speed	3,000 RPM
Maximum motor speed	8,000 RPM
Sound Level at 50 ft. dB(A) scale per ANSI B175.2	57 dB(A)

WARRANTY STATEMENTS

SHINDAIWA LIMITED WARRANTY STATEMENT FOR 56V CORDLESS TOOLS SOLD IN USA AND CANADA

ECHO'S RESPONSIBILITY - ECHO Incorporated's Limited Warranty, provides to the original purchaser that this Shindaiwa product is free from defects in material and workmanship. Under normal use and maintenance from date of purchase, ECHO, Inc. agrees to repair or replace at its discretion, any defective product free of charge at any authorized Shindaiwa servicing dealer within listed below application time periods, limitations and exclusions. **THIS LIMITED WARRANTY IS ONLY APPLICABLE TO SHINDAIWA PRODUCTS SOLD BY AUTHORIZED SHINDAIWA DEALERS. IT IS EXTENDED TO THE ORIGINAL PURCHASER ONLY, AND IS NOT TRANSFERABLE TO SUBSEQUENT OWNERS.** Repair parts and accessories replaced under this warranty are warranted only for the balance of the original unit or accessory warranty period. Any damage caused by improper installation or improper maintenance is not covered by this warranty. All parts or products replaced under warranty become the property of ECHO, Inc. For a list of Authorized Shindaiwa Dealers refer to WWW.SHINDAIWA-USA.COM or call **1-877-986-7783**.

OWNER'S RESPONSIBILITY - To ensure trouble free warranty coverage it is important that you register your Shindaiwa equipment on-line at WWW.SHINDAIWA-USA.COM or by filling out the warranty registration card supplied with your unit. Registering your product confirms your warranty coverage and provides a direct link if we find it necessary to contact you.

The owner shall demonstrate reasonable care and use, and follow preventative maintenance, and storage prescribed in the operator's manual. Should a product difficulty occur, you must, at your expense, deliver or ship your Shindaiwa unit to an authorized Shindaiwa servicing dealer for warranty repairs (within the applicable warranty period), and arrange for pick-up or return of your unit after the repairs have been made. For your nearest authorized Shindaiwa servicing dealer, call Shindaiwa's Dealer Referral Center, at 1-877-986-7783 or you can locate a Shindaiwa servicing dealer at WWW.SHINDAIWA-USA.COM. Should you require assistance or have questions concerning Shindaiwa's Warranty Statement, you can contact our Consumer Product Support Department at 1-800-673-1558 or contact us through the web at WWW.SHINDAIWA-USA.COM.

PRODUCT WARRANTY PERIOD - HOMEOWNER APPLICATION

- **5 YEAR WARRANTY** - All units for homeowner, or non-income producing use will be covered by this limited warranty for **five (5) years** from date of purchase.

EXCEPTIONS:

- Cutting attachments such as, but not limited to, bars, chains, sprockets, tines, blades, PowerBroom™, belts, and nylon trimmer heads for homeowner or non-income producing use will be covered for failures due to defects in material or workmanship for a period of 60 days from original product purchase date. Any misuse from contact with concrete, rocks, or other structures is not covered by this warranty.
- Batteries will be covered against defects in material and workmanship for a period of 2 years from the date of purchase.

PRODUCT WARRANTY PERIOD - COMMERCIAL APPLICATION

- **1 YEAR WARRANTY** - All Chain Saws (and batteries included with them) for commercial, institutional, agricultural, industrial, or income producing use will be covered by this limited warranty for one (1) year from the date of purchase.
- **2 YEAR WARRANTY** - All other units (and batteries included with them) for commercial, institutional, agricultural, industrial, or income producing use will be covered by this limited warranty for two (2) years from the date of purchase.

EXCEPTIONS:

- Cutting attachments such as, but not limited to, bars, chains, sprockets, tines, blades, PowerBroom™, belts, and nylon trimmer heads for commercial, institutional, agricultural, industrial, rental, or income producing will be covered for failures due to defects in material or workmanship for a period of 30 days from original product purchase date. Any misuse from contact with concrete, rocks, or other structures is not covered by this warranty.

Shindaiwa does not offer an over the counter exchange program. Any Shindaiwa product re-built other than by Shindaiwa or sold through an unauthorized dealer, or an unauthorized outlet store, is sold without Shindaiwa's limited warranty coverage. The Shindaiwa Limited Warranty coverage is extended to the original purchaser only, and is not transferable. Repair parts and accessories replaced under this warranty are warranted only for the balance of the original unit or accessory warranty period. Any damage caused by improper installation or improper maintenance is not covered by this warranty. All parts or products replaced under warranty become the property of Echo, Inc.

99922204288
01/30/2015

PRODUCT WARRANTY PERIOD - RENTAL APPLICATION

- **90-DAY WARRANTY** - Units for rental use will be covered against defects in material and workmanship for a period of 90 days from the date of purchase.

PURCHASED REPAIR PARTS AND ACCESSORIES

- 90-day all applications
- Replacement Batteries for all chain saws for commercial, institutional, agricultural, industrial, or income producing use will be covered against defects in material and workmanship for a period of 1 year from the date of purchase.
- Replacement Batteries for all other units and applications will be covered against defects in material and workmanship for a period of 2 years from the date of purchase.
- Replacement chargers will be covered against defects in material and workmanship for a period of 5 years from the date of purchase for homeowner units, and 2 years from the date of purchase for commercial units.

THIS WARRANTY DOES NOT COVER DAMAGE CAUSED BY:

- Operation of the unit with improperly maintained/removed cutting shield.
- Damage caused by dirt, pressure or steam cleaning the unit, salt water, corrosion, rust, varnish, abrasives, and moisture.
- Defects, malfunctions or failures resulting from abuse, misuse, neglect, modifications, alterations, normal wear, improper servicing, or use of unauthorized attachments.
- Incorrect storage procedures, including failure to provide or perform required maintenance services as prescribed in the operator's manual. Preventative maintenance as outlined in the operators manual is the customer's responsibility.
- Failures due to improper set-up, pre-delivery service or repair service by anyone other than authorized Shindaiwa servicing dealer during the warranty period.
- Other parts and items that are not warranted.
- Damage to gears or gear cases caused by contaminated grease or oil, use of incorrect type or viscosity of lubricants, and/or failure to comply with recommended grease or oil change intervals.
- Additional damage to parts or components due to continued use after operational problem or failure occurs. Should operational problem or failure occur, the product should not be used, but delivered as is to an authorized Shindaiwa servicing dealer.

It is a dealer's and/or customer's responsibility to complete and return the warranty registration supplied with your Shindaiwa product or by visiting WWW.SHINDAIWA-USA.COM. Your receipt of purchase including date, model and serial number must be maintained and presented to an authorized Shindaiwa servicing dealer for warranty service. Proof of purchase rests solely with the customer. Some states do not allow limitations on how long an implied warranty lasts, so the above limitations may not apply to you. Some states do not allow the exclusion or limitation of incidental or consequential damages, so you may also have other specific legal rights which vary from state to state. This limited warranty is given by ECHO Incorporated, 400 Oakwood Rd., Lake Zurich, IL 60047.

DISCLAIMER OF IMPLIED WARRANTIES

This limited warranty is in lieu of all other expressed or implied warranties, including any warranty of FITNESS FOR A PARTICULAR PURPOSE OR USE and any implied warranty of **MERCHANTABILITY** otherwise applicable to this product. ECHO, Inc. and its affiliated companies shall not be liable for any special incidental or consequential damage, including lost profits. There are no warranties extended other than as provided herein. This limited warranty may be modified only by ECHO, Inc.

PRODUCT REGISTRATION

Thank you for choosing Shindaiwa Power Equipment

Please go to <http://www.shindaiwa-usa.com> to register your new product on-line. It's **FAST** and **EASY!** NOTE: your information will never be sold or misused by ECHO, Inc. Registering your purchase enables us to contact you in the unlikely event of a service update or product recall, and verifies your ownership for warranty consideration.

If you do not have access to the Internet, you can complete the form below and mail to:

ECHO Inc., Product Registration, PO Box 1139, Lake Zurich IL 60047.



shindaiwa PRODUCT REGISTRATION CARD : TARJETA DE REGISTRO : CARTE D'ENREGISTREMENT DI

ONLINE OPTION: Register online and save a stamp! You will be alerted of product updates and/or be sent new Shindaiwa product information and special offers. Simply go to: www.shindaiwa-usa.com

OPCIÓN POR INTERNET: Regístrese en la página web y ahorre una estampilla! Le alertarán sobre actualizaciones del producto y/o se le enviará información sobre los nuevos productos Shindaiwa y las ofertas especiales. Simplemente visite: www.shindaiwa-usa.com

OPTION EN LIGNE: Enregistrez en ligne et épargnez un timbre. Vous serez informés des nouvelles produits et les offres spéciales. Simplement visitez le: www.shindaiwa-usa.com

Please Print : Por Favor Escribe con Letra De Molde : En Lettre Carré S.V.P. **Confidential: Information provided will not be**

Purchaser's Name : Nombre del Comprador : Nom de l'acheteur	
Address : Dirección : Adresse	
City : Ciudad : Ville	State : Estado : Province
Zip Code : Código Postal : Code Postal	E-Mail Address : Dirección De Correo Electrónico : Courrier Électronique
Phone Number : Número De Teléfono : Téléphone	Date of Purchase : Fecha de la Compra : Date de l'achat
Where Purchased : Nombre del Almacén donde fue Comprado : Lieu d'achat	
Model Number : Numero del Modelo : No. de modèle	Serial Number : Numero de Serie : No. de série

Primary use of tool: Professional Homeowner Rental
 Uso primario de la herramienta: Profesional Dueño de casa Alquiler
 Usage principal: Professionnel Résidentiel Location

Do you wish to receive periodic Shindaiwa product information offers by e-mail? Yes No
 ¿Desea usted recibir información periódica y ofertas especiales por electrónico sobre el producto Shindaiwa? Yes No

Did you visit the Shindaiwa website before purchasing your product? Yes No
 ¿Desea usted recibir información periódica y ofertas especiales por electrónico sobre el producto Shindaiwa? Yes No

Visited the Shindaiwa website before purchasing your product? Yes No
 Avez-vous visité le site d'Shindaiwa avant de procurer votre produit? Oui Non

What factor(s) most influenced your purchase?
 Performance Price Dealer
 Reliability Prior Experience Quality Warranty
 Friend/Family Brand Warranty

¿Qué factor(es) influenció más en su compra?
 Funcionamiento Precio Distribuidor
 Confiabilidad Experiencia Anterior Calidad Garantía
 Amigo/Familia Marca Garantía

Quel facteur (facteurs) vous a influencé le plus?
 Performance Prix Marchand
 Fiabilité Expérience Qualité
 Ami/Famille Marque Garantie

1.877.986.7783 www.shindaiwa-usa.com X75711

NOTES

shindaiwa[®]

ECHO, INCORPORATED

400 Oakwood Road
Lake Zurich, IL 60047

www.echo-usa.com

P90100001001/P90100999999