

User manual

Refrigeration Dryer

PRD10
PRD15
PRD25
PRD35
PRD50
PRD75
PRD100

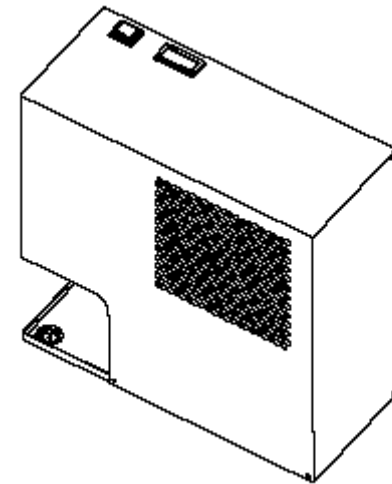

DATE: 2012.06.20 — Rev.2

CODE: 272889



Index

1. Safety
2. Introduction
3. Installation
4. Commissioning
5. Control
6. Maintenance
7. Troubleshooting
8. Appendix

 There are symbols whose meaning is given in the paragraph 8.1.





- 8.1 Legend
- 8.2 Installation diagram
- 8.3 Technical data
- 8.4 Spare parts list
- 8.5 Exploded drawings
- 8.6 Dimensional drawings
- 8.7 Refrigerant circuits
- 8.8 Wiring diagram

1 Safety

1.1 Importance of the manual

- Keep it for the entire life of the machine.
- Read it before any operation.
- It is subject to changes: for updated information see the version on the unit.

1.2 Warning signals



	Instruction for avoiding danger to persons.
	Instruction for avoiding damage to the equipment.
	The presence of a skilled or authorized technician is required.
	There are symbols whose meaning is given in the para.8.

1.3 Safety instructions

 Always disconnect the dryer from the main power supply before starting maintenance work.

 The manual is intended for the end user, only for operations performable with closed panels: operations requiring opening with tools must be carried out by skilled and qualified personnel.

 Do not exceed the design limits given on the dataplate.

  It is the user's responsibility to avoid loads different from the internal static pressure. The unit must be appropriately protected whenever risks of seismic phenomena exist.

 The safety devices on the compressed air circuit must be provided for by the user.

Only use the unit for professional work and for its intended purpose.

The user is responsible for analysing the application aspects for product installation, and following all the applicable industrial and safety standards and regulations contained in the product instruction manual or other documentation supplied with the unit.

Tampering or replacement of any parts by unauthorised personnel and/or improper machine use exonerate the manufacturer from all responsibility and invalidate the warranty.

The manufacturer declines and present or future liability for damage to persons, things and the machine, due to negligence of the operators, non-compliance with all the instructions given in this manual, and non-application of current regulations regarding safety of the system.

The manufacturer declines any liability for damage due to alterations and/or changes to the packing.

It is the responsibility of the user to ensure that the specifications provided for the selection of the unit or components and/or options are fully comprehensive for the correct or foreseeable use of the machine itself or its components.

 **IMPORTANT:** The manufacturer reserves the right to modify this manual at any time.

For the most comprehensive and updated information, the user is advised to consult the manual supplied with the unit.

1.4 Residual risks:

The installation, start up, stopping and maintenance of the ma-

chine must be performed in accordance with the information and instructions given in the technical documentation supplied and always in such a way to avoid the creation of a hazardous situation. The risks that it has not been possible to eliminate in the design stage are listed in the following table.

part affected	residual risk	manner of exposure	precautions
heat exchanger coil	small cuts	contact	avoid contact, wear protective gloves
fan grille and fan	lesions	insertion of pointed objects through the grille while the fan is in operation	do not poke objects of any type through the fan grille or place any objects on the grille
<i>inside the unit:</i> compressor and discharge pipe	burns	contact	avoid contact, wear protective gloves
<i>inside the unit:</i> metal parts and electrical wires	intoxication, electrical shock, serious burns	defects in the insulation of the power supply lines upstream of the electrical panel; live metal parts	adequate electrical protection of the power supply line; ensure metal parts are properly connected to earth
<i>outside the unit:</i> area surrounding the unit	intoxication, serious burns	fire due to short circuit or overheating of the supply line upstream of the unit's electrical panel	ensure conductor cross-sectional areas and the supply line protection system conform to applicable regulations

2 Introduction

This manual refers to refrigeration dryers designed to guarantee high quality in the treatment of compressed air.

2.1 Transport

The packed unit must:

- a) remain upright;
- b) be protected against atmospheric agents;
- c) be protected against impacts.

2.2 Handling

Use a fork lift truck suitable for the weight to be lifted, avoiding any type of impact.

2.3 Inspection

- All units are assembled, wired, filled with coolant and oil, and tested under standard operating conditions in the factory;
- on receiving the machine check its condition: immediately notify the transport company in case of any damage;
- unpack the unit as close as possible to the place of installation.

2.4 Storage

If several units have to be stacked, follow the notes given on the packing. Keep the unit packed in a clean place protected from damp and bad weather.

3 Installation

3.1 Procedures

Install the dryer inside, in a clean area protected from direct atmospheric agents (including sunlight).

☞ Comply with the instructions given in par. 8.2 and 8.3.

All dryers must be fitted with adequate pre-filtration near the dryer air inlet. Seller is excluded any obligation of compensation or refund for any direct or indirect damage caused by its absence..

☞ Pre-filter element (for 3 micron filtration or better) must be replaced at least once a year, or sooner as per manufacturer recommendations.

☞ Do not invert the compressed air inlet and outlet connections and observe the maximum tightening torque (N x m) as specified in par. 8.3.

3.2 Operating space

☞ Leave a space of 60 inches (1.5 m) around the unit.

3.3 Tips

To prevent damage to the internal parts of the dryer and air compressor, avoid installations where the surrounding air contains solid and/or gaseous pollutants (e.g. sulphur, ammonia, chlorine and installations in marine environments).

The ducting of extracted air is not recommended for versions with axial fans.

3.4 Electrical connection

Use approved cable in conformity with the local laws and regulations (for minimum cable section, see par. 8.3).

Install a differential thermal magnetic circuit breaker with contact opening distance ≥ 0.12 inches (3 mm) ahead of the system (IDn = 0.3A) (see the relevant current local regulations). The nominal current In of the magnetic circuit breaker must be equal to the FLA with an intervention curve type D.

3.5 Condensate drain connection

The dryer is supplied either with a float drain, a timed drain or an electronic level sensing drain.

If a timed or electronic unloader is installed, use terminals CN (R1 S1) (see par. 8.8).

For timed and electronic drains: refer to separate manual supplied with the dryer for specific details concerning the condensate drain.

☞ Make the connection to the draining system, avoiding connection in a closed circuit shared by other pressurized discharge lines. Check the correct flow of condensate discharges. Dispose of all the condensate in conformity with current local environmental regulations.

4 Commissioning

4.1 Preliminary checks

Before commissioning the dryer, make sure:

- installation was carried out according that given in the section 3;
- the air inlet valves are closed and that there is no air flow through the dryer;
- the power supply is correct;

4.2 Starting

- Start the dryer before the air compressor by means of the main power switch ⑭; the power lamp will illuminate (green);
- after at least 5 minutes slowly open the air inlet valve and subsequently open the air outlet valve: the dryer is now performing its air drying function.

4.3 Operation

- Leave the dryer on during the entire period the air compressor is working;
- the dryer operates in automatic mode, therefore field settings are not required;

- in the event of unforeseen excess air flows, by pass to avoid overloading the dryer;

4.4 Stop

- Stop the dryer 2 minutes after the air compressor stops or in any case after interruption of the air flow;
- do not allow compressed air to flow through the dryer when the latter is not running;
- switch off at the main power switch ⑭. The power light goes out and the compressor stops.

5 Control

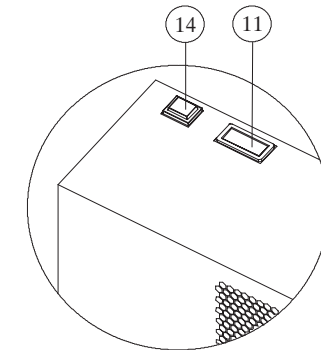

⑪ Dewpoint indicator

⑭ Main power switch

The dewpoint indicator can show one of three conditions:

blue: dewpoint too low
green: dewpoint ideal
red: dewpoint too high

6 Maintenance

- The machine is designed and built to guarantee continuous operation; however, the life of its components depends on the maintenance performed;
- when requesting assistance or spare parts, identify the machine (model and serial number) by reading the dataplate located on the unit.

6.1 General instructions

 Before any maintenance, make sure:

- the pneumatic circuit is no longer pressurized;
- the dryer is disconnected from the main power supply.

 Always use the Manufacturer's original spare parts: otherwise the Manufacturer is relieved of all liability regarding machine malfunctioning.

 In case of refrigerant leakage, contact qualified and authorized personnel.

 The Schrader valve must only be used in case of machine malfunction: otherwise any damage caused by incorrect refrigerant charging will not be covered by the warranty.

6.2 Refrigerant







Charging: any damage caused by incorrect refrigerant replacement carried out by unauthorized personnel will not be covered by the warranty.

 At normal temperature and pressure, the R134a refrigerant is a colourless gas classified in SAFETY GROUP A1 EN378 (group 2 fluid according to Directive PED 97/23/EC); GWP (Global Warming Potential) = 1300.

 In case of refrigerant leakage, ventilate the room.

6.3 Preventive Maintenance Programme

To guarantee lasting maximum dryer efficiency and reliability:

Maintenance Activity Description	Maintenance Interval (standard operating conditions)			
	Daily	Weekly	4 Months	12 Months
Check POWER ON indicator is lit.				
Check control panel indicators.				
Check condensate drain.				
Clean condenser fins.				
Check electrical absorption.				
Depressurize the dryer. Complete drain maintenance.				
Depressurize the dryer. Replace pre and post filter elements.				



check



service

The following are available (see par. 8.4):

- compressor kits;
- fan kits;
- automatic expansion valve kits;
- individual spare parts.

6.4 Dismantling

The refrigerant and the lubricating oil contained in the circuit must be recovered in conformity with current local environmental regulations.

	Recycling Disposal
structural work	steel/epoxy polyester resins
exchanger	aluminium
pipes	aluminium/copper
drain	polyamide
exchanger insulation	EPS (sintered polystyrene)
pipe insulation	synthetic rubber
compressor	steel/copper/aluminium/oil
condenser	steel/copper/aluminium
refrigerant	R134a
valves	brass
electrical cables	copper/PVC

7 Troubleshooting

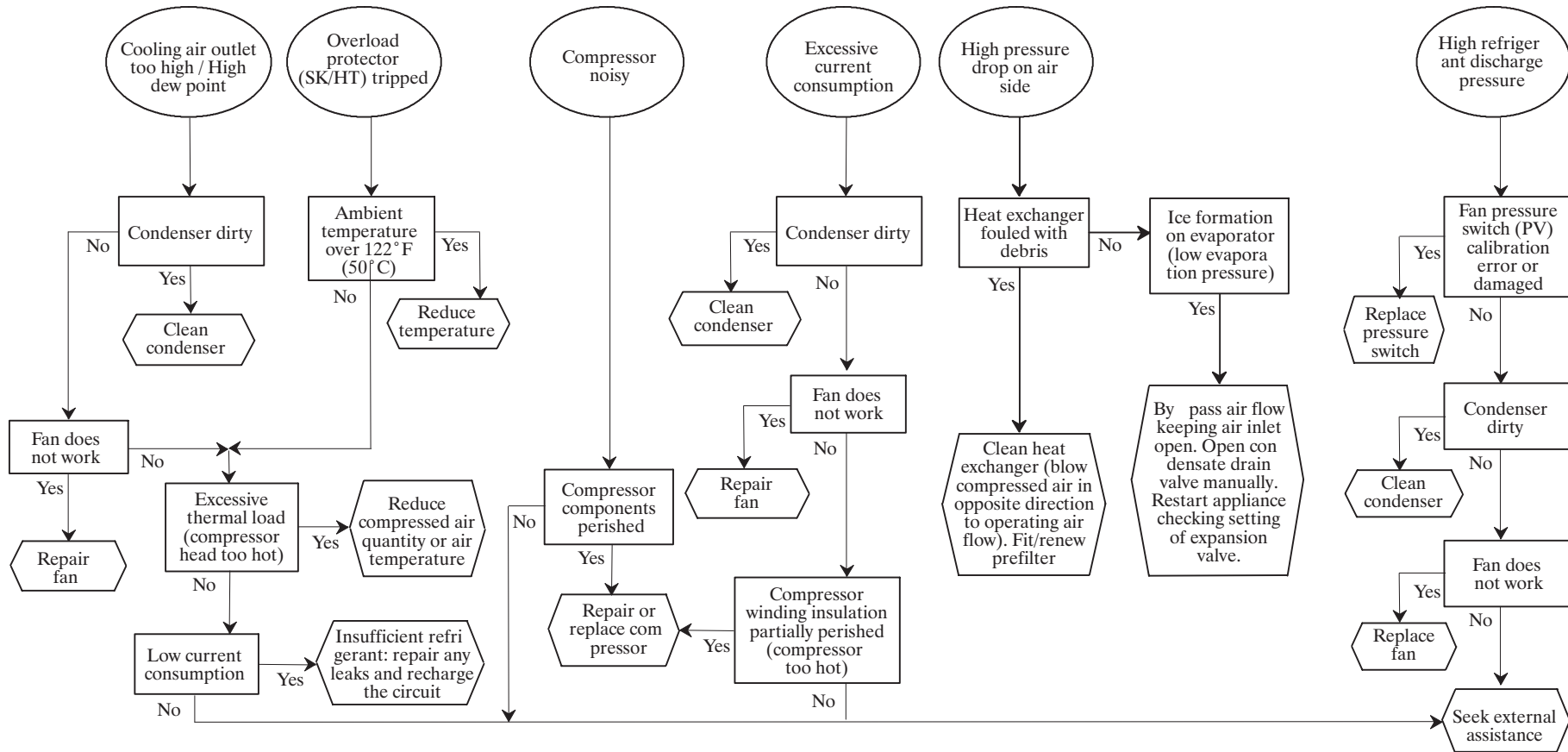

8 Appendix





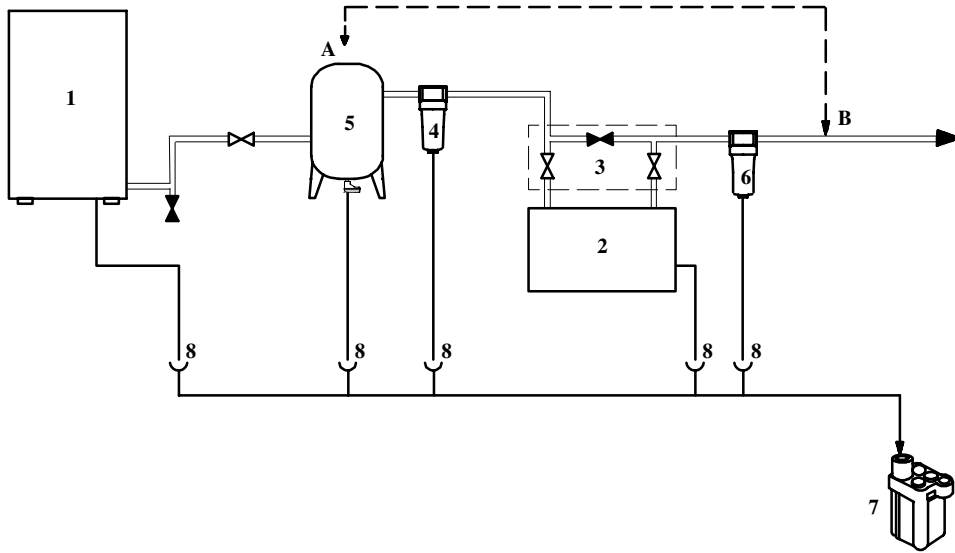

8.1 Legend

	Meaning		Meaning
① MC	Compressor	⑫ PV	Fan pressure switch
②	Refrigerant condenser	⑬ HT	High temperature safety thermostat
③ EV	Fan motor	⑭ QS	Main power switch
④	Evaporator	⑮	Cover
⑤	Separator	CN	Electronic condensate drain power supply
⑥	Power cable	SK	Overload protector
⑦ AEV	Expansion automatic valve	KA	Starting relay
⑧	Refrigerant filter	C	Compressor starting capacitor
⑩	Air---air exchanger	QF	Residual---current automatic circuit breaker
⑪	Dewpoint indicator		

8.2 Installation diagram



1	Air compressor
2	Dryer
3	By---pass unit
4	Filter (3 micron filtration or better) near dryer air inlet
5	Tank in position A or in B
6	Outlet filter
7	Oil---Water separator
8	Condensate drain

 	Safety valves for not exceeding dryer design pressure
 	Hoses for air connections if the system undergoes vibrations
 	Suitable dampers if the system undergoes pulsations

8.3 Technical data

	Weight		Refrigerant		MIN. MAX. Ambient temperature		Compressed air inlet temperature	Air side max. working pressure	E.L.A. [A]		Minimum section validated cable for electrical connection	Compressed air inlet/outlet	Connections (Tightening torque)	Sound pressure level				
	(lb)	(kg)	(oz)	(kg)	During transport and stockage	After installation			115V±10% 1ph/60Hz	230V±10% 1ph/60Hz					Ø	NPT	[N x m]	[dB(A)]
PRD10	41.8	19	5.99	0.17	32 122°F 0 50°C	41 122°F 5 50°C	149°F 65°C	232 PSIG 16 bar	3.74		3G16AWG	NPT (compatible) 1/2"	50	50				
PRD15																		
PRD25	51.8	23.5	9.52	0.27														
PRD35																		
PRD50	58.4	26.5	8.81	0.25											8.31			NPT (with adaptor) 3/4"
PRD75	68.3	31	9.52	0.27											10.23			
PRD100	77.2	35	12.34	0.35											12.44	6.22		

Calibration values	Expansion automatic valve	Fan pressure switch
	AEV	12 PV
PRD10--PRD15	35 PSIG (+1.5, 0) 2.4 bar (+0.1, 0)	ON: 160 PSIG OFF: 116 PSIG
PRD25--PRD100	32 PSIG (+1.5, 0) 2.2 bar (+0.1, 0)	ON: 11 bar OFF: 8 bar

8.4  Spare parts list

		(8.5)	PRD10	PRD15	PRD25	PRD35	PRD50	PRD75	PRD100
a)	Compressor kit (115V/1Ph/60Hz)	① ⑧	SP-147439		SP-147405		SP-147100	SP-147339	SP-147341
	(230V/1Ph/60Hz)		—						
b)	Fan kit (115V/1Ph/60Hz)	③	SP-381679		SP-381793				SP-381616
	(230V/1Ph/60Hz)		—						
c)	Automatic expansion valve kit	⑦ ⑧	SP-473108						SP-473109
d)	Refrigerant condenser	②	SP-114800		SP-114801		SP-114802	SP-114803	SP-114754
	Evaporator/Separetor/Air-air heat-exchanger	④ ⑤ ⑩	SP-472157		SP-472158		SP-472159		
	Power cable	⑥	SP-256347						
	Refrigerant filter	⑧	SP-206214						
	Dewpoint indicator	⑪	SP-354317						
	Fan pressure switch	⑫	SP-354376						
	High temperature safety thermostat	⑬	SP-473399						
	Main power switch	⑭	SP-255132						
Cover	⑮	SP-137926		SP-137928		SP-137931			

8.5  Exploded drawing

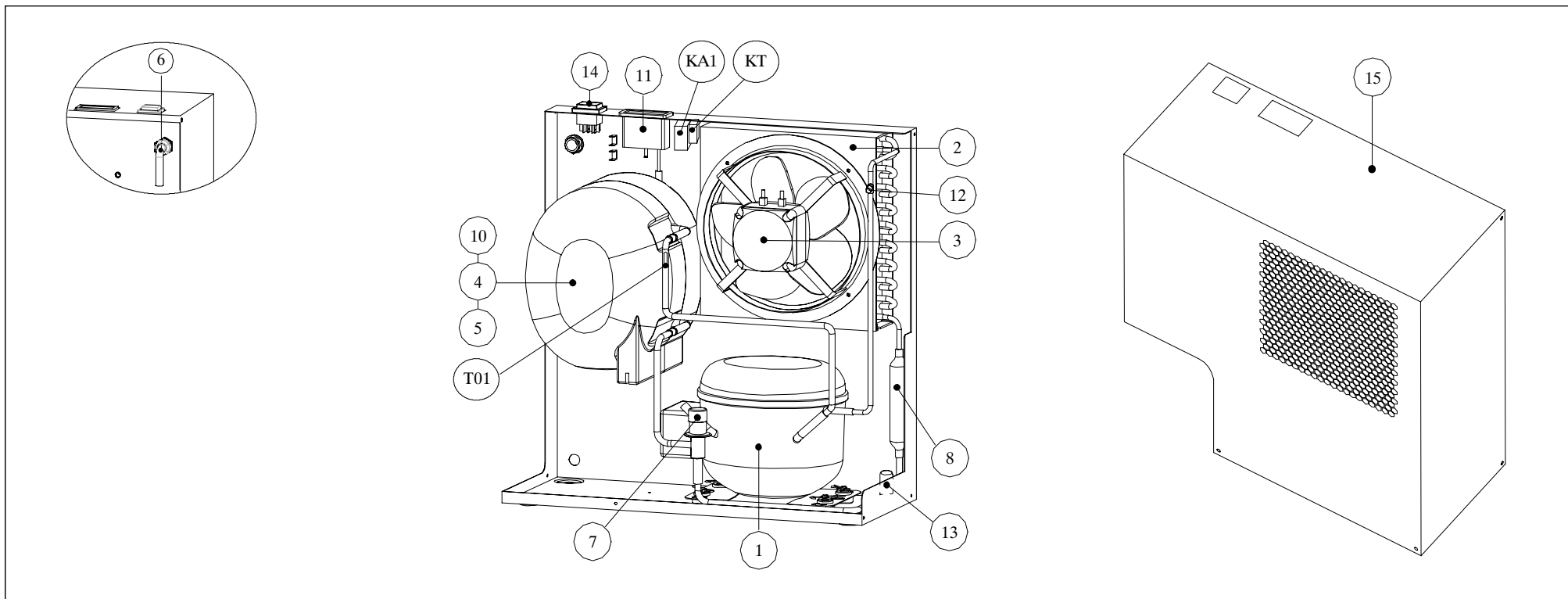

8.6  Dimensional drawing PRD10--PRD15

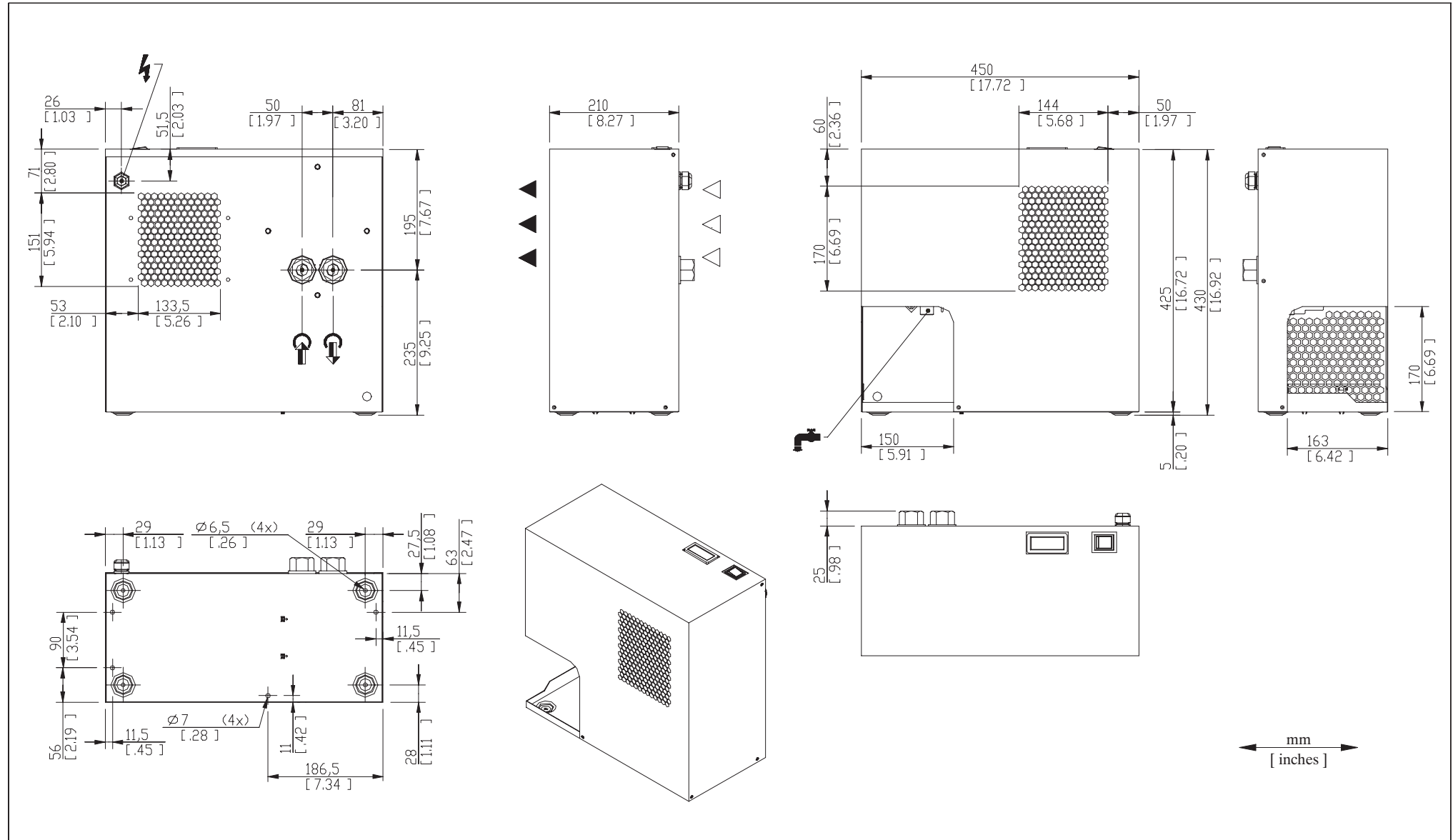

 Dimensional drawing PRD25--PRD35

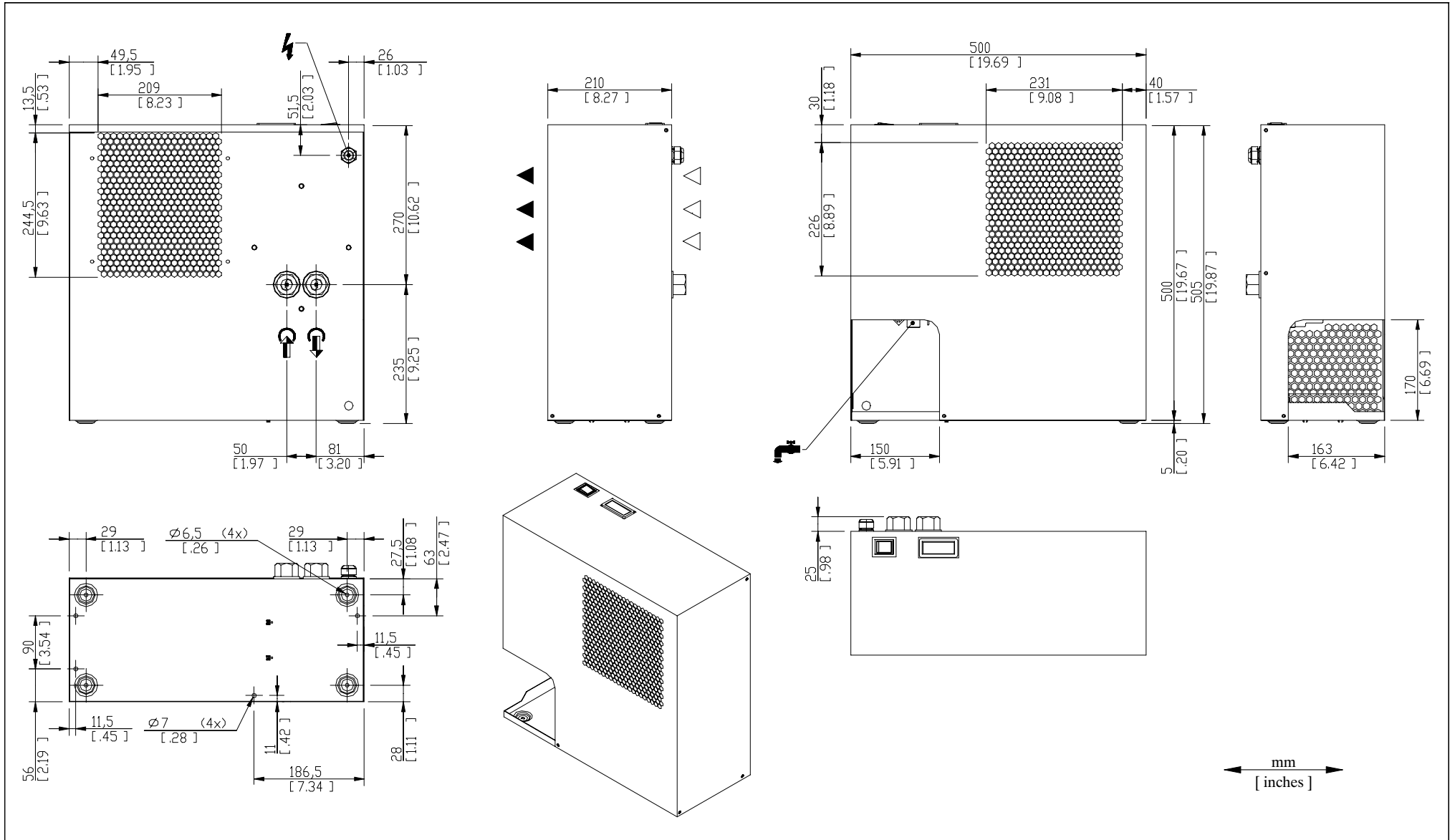

 Dimensional drawing PRD50--PRD100

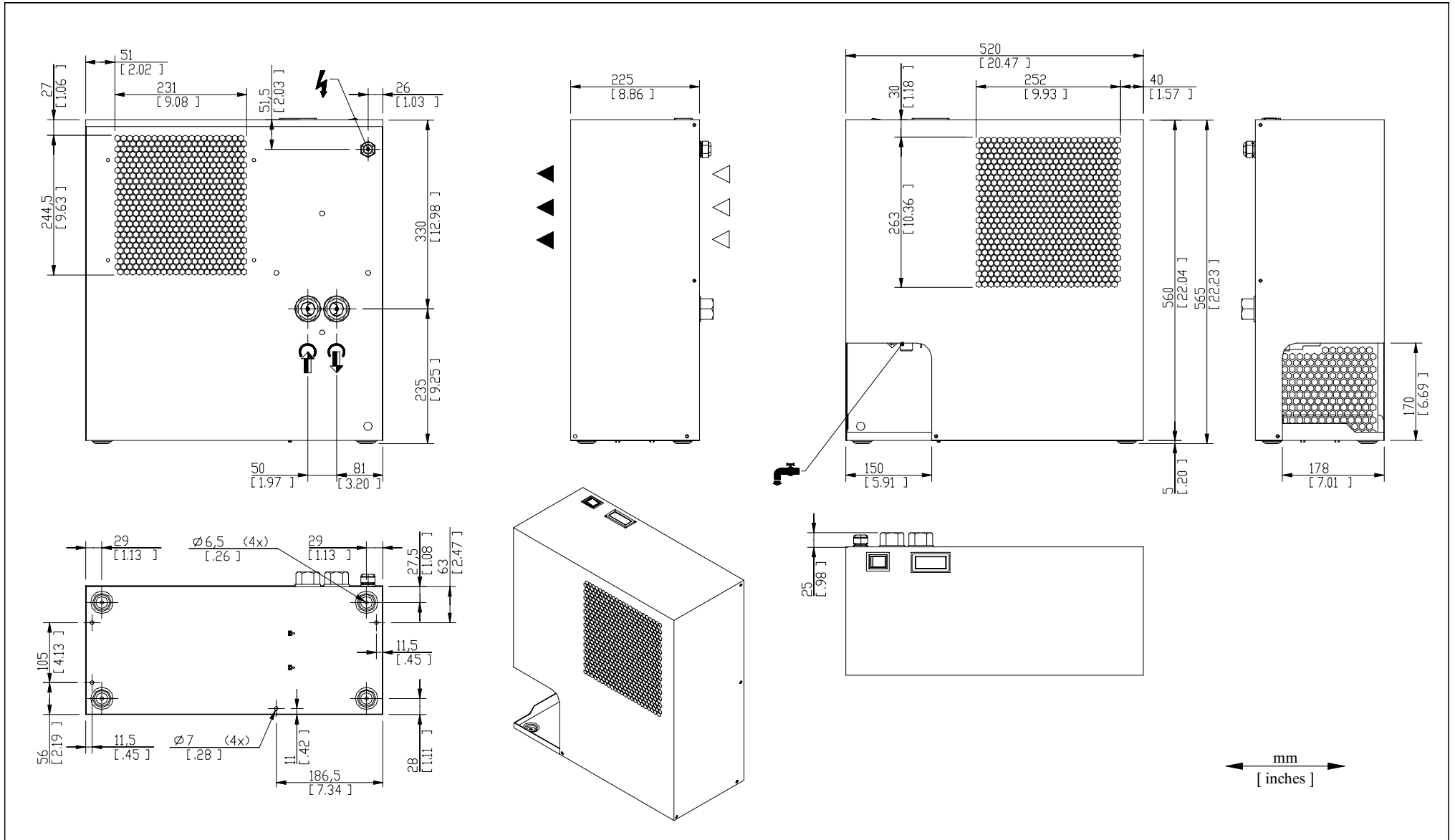

8.7  Refrigerant circuit

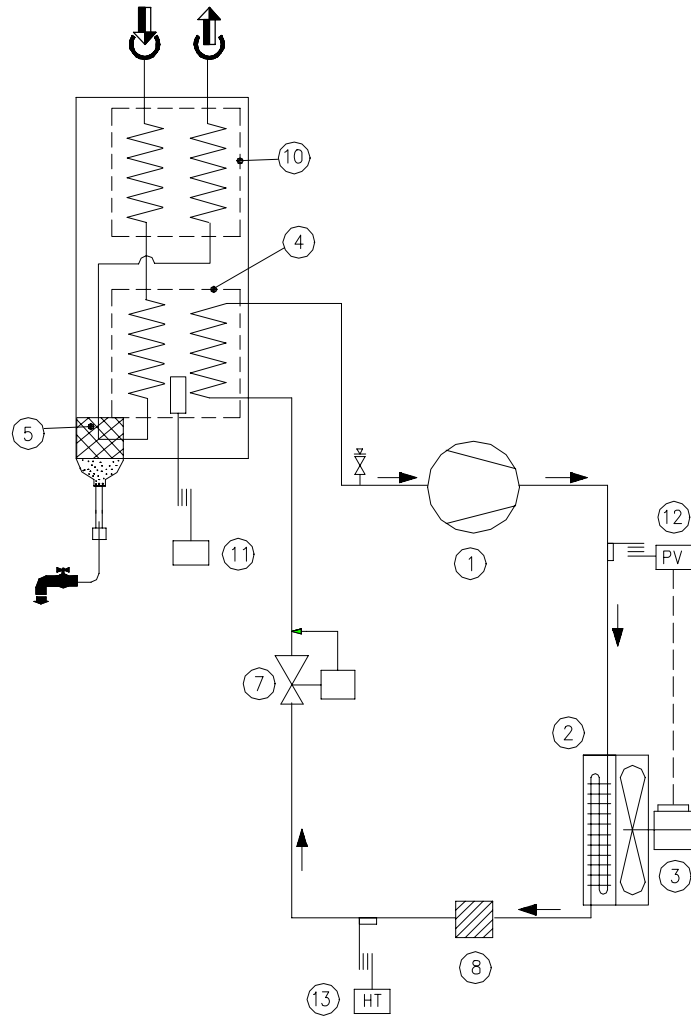

 **Wiring diagram PRD25--PRD100**

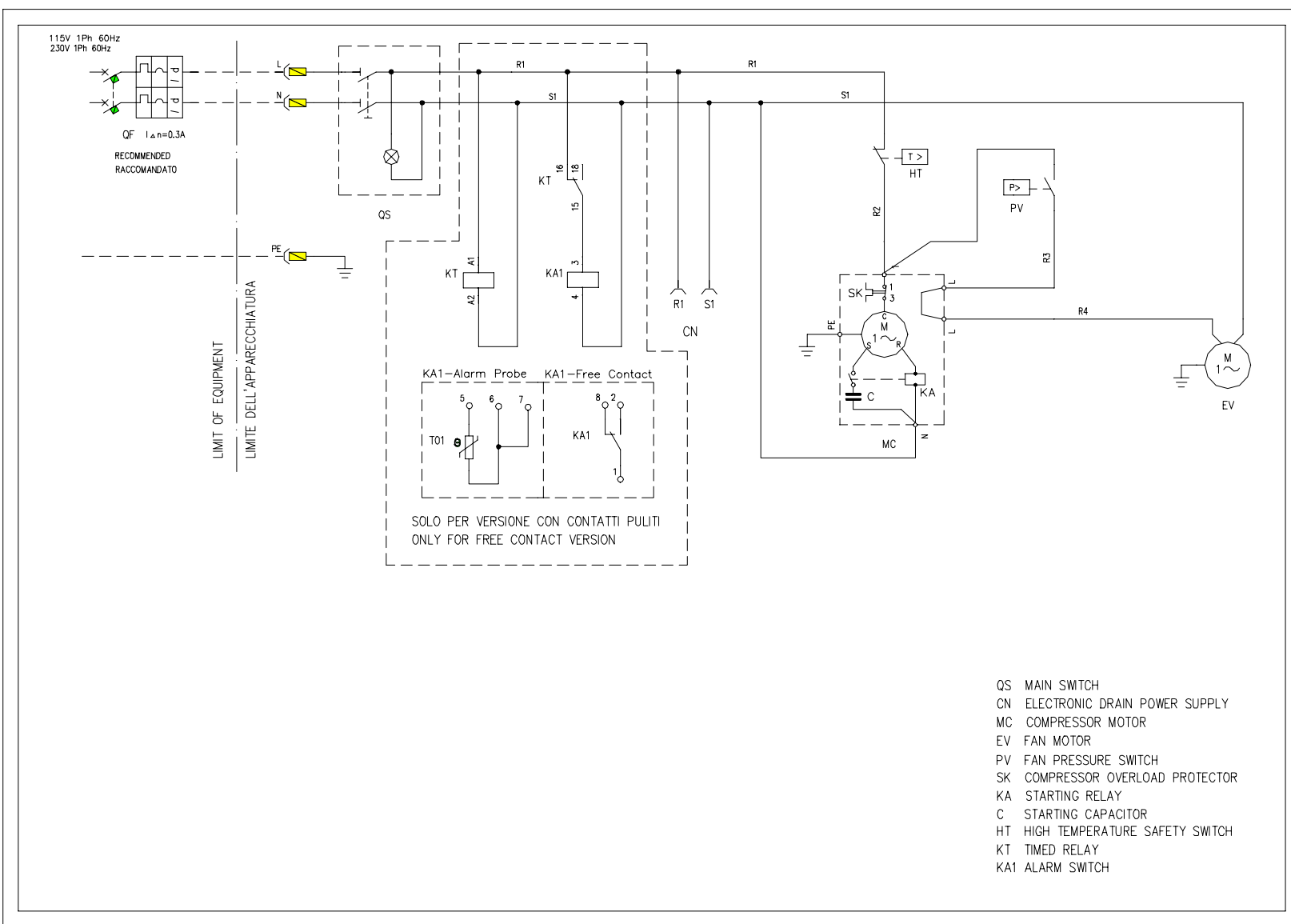

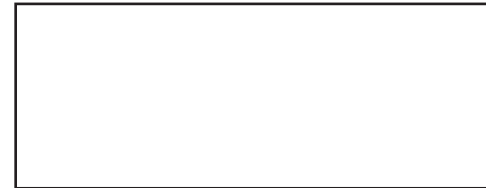

© 2012 Parker Hannifin Corporation. Product names are trademarks or registered trademarks of their respective companies



Parker Hannifin Corporation
Finite Airtek Filtration Division
4087 Walden Avenue
Lancaster, NY 14086
phone 716 686 6400
www.parker.com/faf