

Please carefully read and save these instructions before attempting to assemble, maintain, install, or operate this product. Observe all safety information to protect yourself and others. Failure to observe the instructions may result in property damage and/or personal injury. Please keep instructions for future reference.

Important Operating Instructions



34 DEGREE 3-1/2 INCH CLIPPED HEAD FRAMING NAILER

Model: 7566

CALIFORNIA PROPOSITION 65

WARNING: You can create dust when you cut, sand, drill or grind materials such as wood, paint, metal, concrete, cement, or other masonry. This dust often contains chemicals known to cause cancer, birth defects, or other reproductive harm. Wear protective gear.

WARNING: This product or its power cord may contain chemicals, including lead, known to the State of California to cause cancer and birth defects or other reproductive harm. Wash hands after handling.

Important!

When using equipment, a few safety precautions must be observed to avoid injuries and damage. Please read the complete operating manual with due care. Keep this manual in a safe place, so that the information is available at all times. If you give the equipment to any other person, give them these operating instructions as well. We accept no liability for damage or

accidents which arise due to non-observance of these instructions and the safety information herein.

SPECIFICATIONS

Normal Operating Pressure:
70 PSI - 115 PSI

Maintenance: Oiling

Firing Mode: Sequential Fire/
Contact Fire

Fastener Size Range:
2 inches to 3-1/2 inches

Capacity: 90 pieces

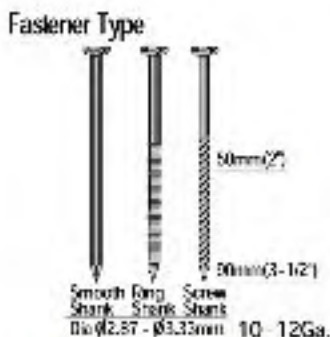

FEATURES

- 360° adjustable exhaust cover
- Comfortable rubber grip
- Lightweight magnesium housing
- Adjustable depth of penetration
- Anti-dry firing mechanism
- Single sequential, full

sequential, and dual action are exchangeable.

- No-Mar Tip protects work surface.

Keep this manual and receipt in a safe and dry place for future reference.

CAUTION:

FOR YOUR OWN SAFETY READ INSTRUCTION MANUAL COMPLETELY AND CAREFULLY BEFORE OPERATING THIS 3-1/2 INCH CLIPPED HEAD FRAMING NAILER.

Any failures made in following the safety regulations and instructions may result in an electric shock, fire and/or serious injury.

EXPLANATION OF NAILING ACTION

- SINGLE ACTUATION MECHANISM: First, press the safety against the wood. Next, pull the trigger to drive the fastener. After fastening once, fastening will not be possible again until the

For warranty purchases, please keep your dated proof of purchase. File or attach to the manual for safekeeping.

trigger is released and pressed again.

• **CONTACT ACTUATION MECHANISM:** First, pull the trigger. Next, press the safety against the wood to drive the fastener. If the trigger is held back, a fastener will be driven each time the safety is pressed against the wood.

• **FULL SEQUENTIAL ACTUATION MECHANISM:** First, press the safety against the wood. Next, pull the trigger to drive the fastener. Follow the same sequence to continue driving fasteners.

GENERAL SAFETY RULES

WORK AREA

- **KEEP THE WORK AREA CLEAN AND WELL LIT.** Cluttered benches and dark areas increases the risk of injury.
- **DO NOT OPERATE THE TOOL IN EXPLOSIVE ATMOSPHERES,** such as in the presence of flammable liquids, gases, or dust. The tool may create a spark that could ignite flammable liquids, gases, or dust.
- **KEEP VISITORS AWAY.** Do not let visitors handle the tool. All visitors should be kept safely away from the work area.
- **NEVER ENGAGE IN HORSEPLAY WITH THE TOOL.** Respect the tool as a working implement.

PERSONAL SAFETY

• **OPERATORS AND OTHERS IN WORK AREA MUST WEAR SAFETY GLASSES WITH SIDE SHIELDS.** Safety glasses must conform to ANSI Z87.1 specifications.

• **ALWAYS WEAR EAR AND HEAD PROTECTION.** Wear ear protection to protect your ears from loud noises. Wear head protection to protect your head from flying objects.

• **USE SAFETY EQUIPMENT.** A dust mask, non-skid safety shoes, and a hard hat must be used for the applicable conditions. Wear a full face shield if you are producing metal filings or wood chips.

• **DRESS PROPERLY.** Do not wear loose clothing or jewelry. Contain long hair. Keep hair, clothing, and gloves away from moving parts. Loose clothes, jewelry, or long hair can be caught in moving parts and increase the risk of injury.

• **STAY ALERT, WATCH WHAT YOU ARE DOING AND USE COMMON SENSE WHEN OPERATING A POWER TOOL.** Do not use tool while tired or under the influence of drugs, alcohol, or medication. A moment of inattention while operating the tool may cause serious injury.

• **AVOID UNINTENTIONAL FIRING.** Keep fingers away from trigger when not driving fasteners, especially when connecting the tool to the air supply.

• **DO NOT OVERREACH.** Keep

proper footing and balance at all times. Proper footing and balance enables better control of the tool in unexpected situations.

• **MAKE SURE AIR HOSE IS FREE OF SNAGS AND OBSTRUCTIONS. DO NOT ATTACH AN AIR HOSE OR TOOL TO YOUR BODY.** Entangled or snarled hoses can cause a loss of balance or footing in addition to unintentional tool operation.

TOOL USE AND CARE

• **NEVER POINT THE TOOL AT YOURSELF OR OTHERS IN THE WORK AREA.** Always assume the tool contains fasteners. Never point the tool at yourself or others, whether it contains fasteners or not.

• **KEEP FINGERS AWAY FROM TRIGGER WHEN NOT DRIVING FASTENERS TO AVOID ACCIDENTAL FIRING.** Never carry the tool with the trigger depressed, since you could unintentionally drive a fastener and injure yourself or someone else. Always carry the tool by the handle.

• **NEVER MODIFY OR ALTER THE TOOL.** Doing so may cause the tool to malfunction and personal injuries may result.

• **KNOW THIS TOOL.** Read this manual carefully. Learn its applications and limitations, as well as the specific potential hazards related to this tool.

• **USE ONLY FASTENERS THAT ARE RECOMMENDED FOR YOUR MODEL.** Do not use the

wrong fasteners or load the fasteners incorrectly.

- **CHECK FOR MISALIGNMENT OR BINDING OF MOVING PARTS, BREAKAGE OF PARTS, OR ANY OTHER CONDITION THAT MAY AFFECT THE TOOL'S OPERATION.** If damaged, have the tool serviced by an authorized technician before using. Many accidents are caused by poorly maintained tools.
- **CHECK SAFETY BEFORE USE.** Make sure the safety operates properly. Never use the tool if the safety is not operating properly. Do not tamper with or remove the safety.
- **DO NOT USE THE TOOL IF THE TRIGGER DOES NOT ACTUATE PROPERLY.** Any tool that cannot be controlled with the trigger is dangerous and must be repaired.
- **NEVER USE A TOOL THAT IS DEFECTIVE OR OPERATING ABNORMALLY.** If the tool appears to be operating unusually, making strange noises, or otherwise appears defective, stop using it immediately and arrange for repairs by an authorized service center.
- **MAINTAIN TOOLS WITH CARE.** Keep the tool clean and lubricated for better and safer performance.
- **NEVER CARRY THE TOOL BY THE AIR HOSE.**

- **STORE TOOLS OUT OF THE REACH OF CHILDREN AND UNTRAINED PEOPLE.** Tools are dangerous in the hands of untrained users.
- **PLACE TOOL PROPERLY ON THE WORK PIECE.** Do not drive fasteners on top of other fasteners or with the tool at too steep of an angle. The fasteners can ricochet and cause serious injury.
- **DO NOT USE TOOL AS A HAMMER.**
- **KEEP ALL SCREWS AND COVERS TIGHTLY IN PLACE.**
- **KEEP FACE, HANDS, AND FEET AWAY FROM FIRING HEAD AT ALL TIMES.**
- **DO NOT DISCONNECT AIR HOSE FROM TOOL WITH YOUR FINGER ON THE TRIGGER.** The tool can fire when reconnected to an air supply.
- **DO NOT LOAD FASTENERS WITH TRIGGER PULLED OR SAFETY DEPRESSED.**
- **NEVER PLACE A HAND OR ANY PART OF THE BODY IN FASTENER DISCHARGE AREA OF TOOL.**
- **DO NOT DRIVE FASTENERS INTO THIN BOARDS OR NEAR EDGES OF WORK PIECE.**
- **DISCONNECT AIR HOSE FROM TOOL WHEN:**
 1. Doing maintenance and inspection
 2. Loading fasteners

3. Turning the adjuster and top cover
4. Clearing a jam
5. It is not in use
6. Leaving the work area
7. Moving it to another location
8. Handing it to another person

NOTE: Never attempt to clear a jam or repair the tool unless you have disconnected the air hose from the tool and removed all remaining fasteners from the tool.

TOOL SERVICE

- **USE ONLY ACCESSORIES THAT ARE IDENTIFIED BY THE MANUFACTURER FOR THE SPECIFIC TOOL MODEL.**
- **USE OF UNAUTHORIZED PARTS OR FAILURE TO FOLLOW MAINTENANCE INSTRUCTIONS MAY CREATE A RISK OF INJURY.**
- **USE ONLY THE LUBRICANTS SUPPLIED WITH THE TOOL OR SPECIFIED BY THE MANUFACTURER.**
- **TOOL SERVICE MUST ONLY BE PERFORMED BY A QUALIFIED REPAIR PERSONNEL.**

AIR SOURCE

- **NEVER USE OXYGEN OR OTHER BOTTLED GASES AS A POWER SOURCE.** Explosion may occur. Combustible gases and other bottled gases are dangerous and may cause the tool to explode.

DO NOT EXCEED THE MAXIMUM RECOMMENDED AIR PRESSURE MARKED ON THE TOOL. Use only clean, dry, regulated, compressed air within the rated pressure range marked on the tool. Never connect the tool to pressure that could potentially exceed 200 PSI.

- DO NOT ABUSE THE AIR HOSE. Protect all hoses from kinks, restrictions, solvents, or sharp objects. Keep air hose away from heat, oil, sharp edges, or moving parts. Replace damaged hoses immediately. Damaged hoses can burst or whip around.

- CHECK ALL FITTINGS, HOSES, PIPES, CONNECTIONS, AND COMPRESSOR BEFORE EACH USE. Repair or replace damaged or leaking hoses and connections immediately. Damage to a hose or connection may cause a pressure hose to break and whip around the work area, which may lead to injury.

FUNCTIONAL DESCRIPTION

(See Fig 1)

WARNING

Disconnect the tool from the air source before making any adjustments, changing accessories, or storing the tool. Such precautionary safety measures reduce the risk of unintentional tool operation.

FIG. 1

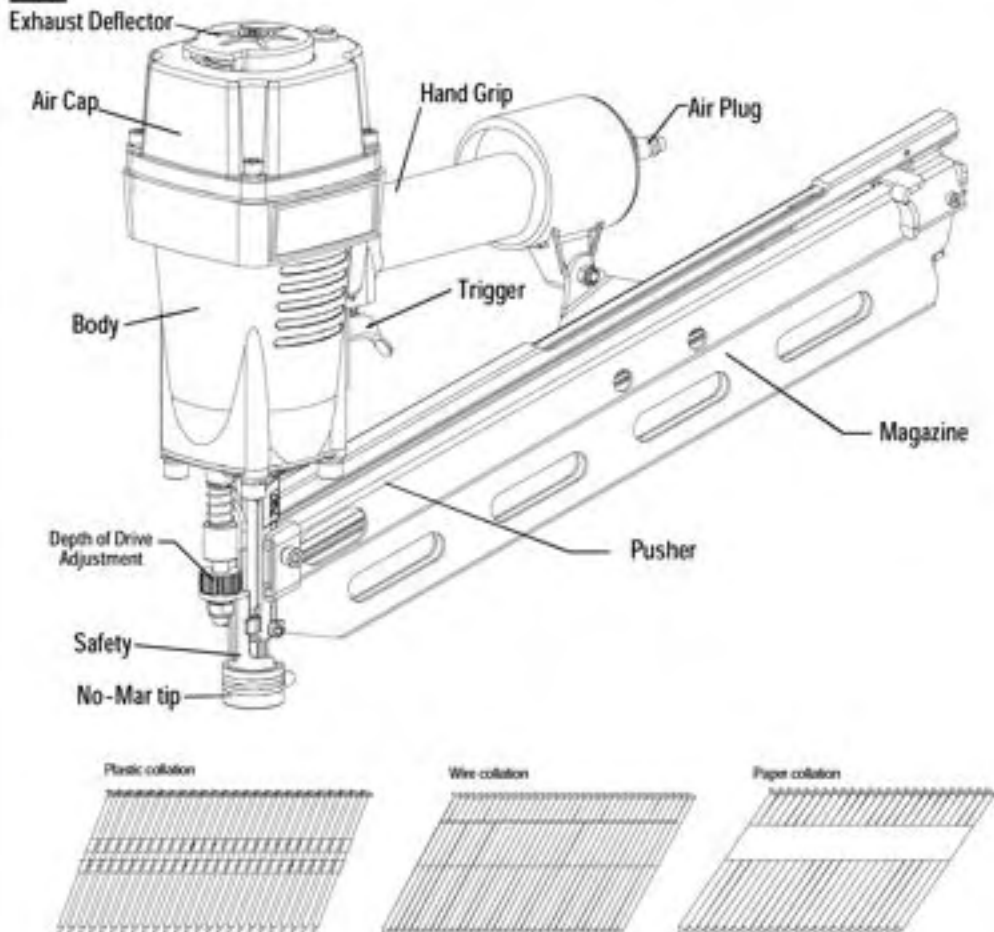

ASSEMBLY/ INSTALLATION

Follow the instructions below to prepare your tool for operation.

1. All tool operators and their immediate supervisors must become familiar with the operator safety instructions before operating the tool.
2. Included with each tool is one copy of these operating/safety instructions. Keep this publication for future reference.
3. Select a hose with a

minimum inner diameter of 1/4 inch and a maximum length of 100 feet.

WARNING

To reduce the risk of injury from a hose bursting, select hoses that are rated at a maximum of 200 PSI.

4. Select fittings that are appropriately sized for the selected hoses. The tool and air hose must have a hose coupling such that all pressure is removed from the tool when the coupling joint is disconnected.

WARNING

Never use non-relieving couplers and/or female quick disconnect couplings on the tool. Non-relieving coupling and female couplings will trap high pressure air in the tool when the air line is disconnected. This will leave the tool charged with enough air after it has been disconnected to drive a nail. Only MALE pneumatic type air connectors should be fitted to the tool, so that high pressure air in the tool is vented as soon as the air line is disconnected.

5. Set the regulator at the air delivery system to a PSI that falls within the tool's operating range of 70-115 PSI. The correct pressure is the lowest pressure that will do the job.

OPERATION

LUBRICATION

WARNING

USE ONLY THE AIR TOOL LUBRICANTS SUPPLIED WITH THE TOOL. Do not use other lubricants as they may damage the tool. If the tool is not used with an in-line lubrication system on the air supply, it is necessary to periodically lubricate the tool with air tool lubrication.

Under low use, lubricate once a day. Under heavy use, lubricate twice a day.

To lubricate, insert 2-3 drops

of lubricant into the air supply fitting attached to the tool handle (Figure 2). Using too much oil will cause it to collect in the tool and be noticeable in the exhaust.

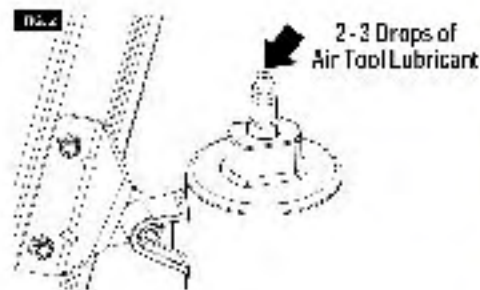

Do not use detergent oil, WD-40, transmission fluid, motor oil, or other lubrication not specifically designed as air tool lubricants. These lubricants will cause accelerated wear to the seals, O-rings, and bumpers in the tool, resulting in poor tool performance and frequent maintenance.

ADJUSTING AIR PRESSURE

Adjust the air pressure at recommended operating pressure, 70-115 PSI, according to the length of nails and the hardness of the work piece.

The correct air pressure is the lowest pressure that will do the job. Using the tool at a higher than required air pressure unnecessarily over stresses the tool. Do not exceed 120 PS and do not go under 70 PSI.

CONNECTING AIR SUPPLY

WARNING

Never use oxygen or other bottled gases as a power source. Explosions may occur. Combustible gases are dangerous and may cause the tool to explode.

WARNING

Never connect the tool to an air source that is capable of producing air pressure exceeding 200 PSI. Excessive pressure can cause abnormal operation or cause the tool to burst, resulting in personal injury.

WARNING

Do not exceed maximum recommended air pressure marked on the tool. Verify prior to using the tool that the air source has been adjusted within the rated air pressure range. Be sure the air pressure gauge is operating properly and check it at least twice a day. Tools operated in excess of their maximum pressure rating may operate abnormally or burst, resulting in personal injury.

To connect the tool to the compressor, only use pneumatic air hoses that meet the following criteria:

1. Maximum hose pressure rating: 200 PSI
2. Minimum hose inner diameter: 1/4 inch
3. Maximum hose length: 100 feet

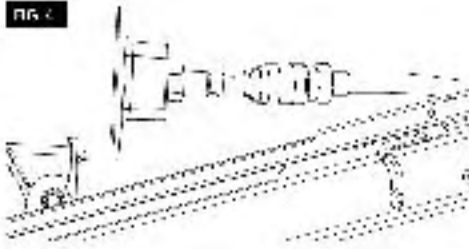

CONNECT THE AIR SUPPLY (Refer to Figure 4)

- Snap the air hose onto the quick connector.
- Check for air leakage. If leakage is noted, cease using the tool immediately and have it checked by a qualified repair personnel.
- Be sure the air pressure gauge is operating properly and check it at least twice a day.

TOOL TESTING

DANGER

OPERATORS AND OTHERS IN WORK AREA MUST WEAR SAFETY GOGGLES WITH SIDE SHIELDS, WHICH CONFORM TO ANSI Z87.1 SPECIFICATION.

WARNING

NEVER USE TOOL UNLESS SAFETY IS OPERATING PROPERLY. Before actually beginning the nailing work, test the tool by using the checklist below. Conduct the test in the following order.

If abnormal operation occurs, stop using the tool and have it repaired by a qualified repair personnel immediately.

1. Disconnect air hose and remove all nails from the tool. All screws must be tightened. If any screws are loose, tighten them.

The safety and trigger must move smoothly.

2. Adjust the air pressure to 70 PSI and then connect the air hose. The tool must not leak air.

3. Remove the finger from the trigger and press the safety against the wood. The tool must not operate.

4. Separate the safety from the wood. Next, point the tool downward, pull the trigger and then wait in that position for 5 seconds or longer. The tool must not operate.

5. Without touching the trigger, depress the safety against the work piece. Pull the trigger. The tool must not operate.

Hold the trigger back while separating the safety from the wood. The tool will remain in operated status (the driver blade will remain at the bottom).

Remove the finger from the trigger. Tool operation will end (the driver blade will return to the top).

6. If no abnormal operation is observed, you may load nails in the tool. Drive nails into the work piece that is the same type to be used in the actual application. The tool must operate properly.

NAIL LOADING

(Refer to Figure 5)

WARNING

Always load nails into the tools magazine before the air supply is connected. Connecting the air supply after loading nails

reduces the risk of unintentionally driving a nail and injuring yourself or someone else.

WARNING

When loading the tool's magazine, check that the nail tips contact the wear rail and slide smoothly against the surface of the magazine. If the nails are not loaded properly, the tool will misfire and nails can be deflected, causing the tool to react in an unexpected manner and damage the tool.

1. Disconnect the air supply.
2. Hold the tool handgrip securely and pull pusher back until it locks in latched position at rear of magazine.
3. Insert nail strip into magazine, with nail points angled forward and down.
4. Pull pusher back, press release lever, and slide pusher forward against nails.
5. Tool is now loaded and ready for normal operation.

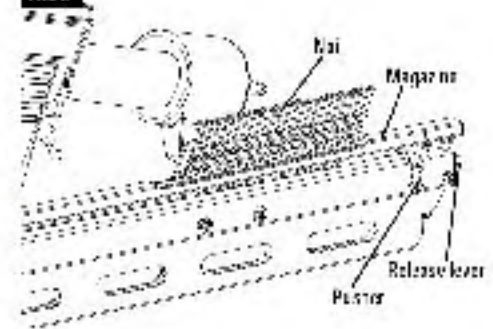

METHODS OF OPERATION

This tool is equipped with a safety and does not operate unless the safety is depressed.

There are two methods of operation to drive nails with this tool: sequential fire and contact fire (red trigger).

SEQUENTIAL FIRE

1. Position the nail outlet on the work piece with finger off the trigger.
2. Depress the safety firmly until it is completely depressed.
3. Pull the trigger to drive a nail.
4. Remove finger from trigger.

To continue nailing in a separate location, move the tool along the wood, repeating steps 2-4 as required.

CONTACT FIRE

WARNING

To avoid double firing or accidental firing due to recoil:

- Do not press the tool against the wood with excessive force.
- Separate the tool from the wood as it recoils after nailing.

CONTACT TRIGGER LOAD

1. Disconnect the tool from the air source.
2. Remove the O-ring from the trigger pin (Fig 6).

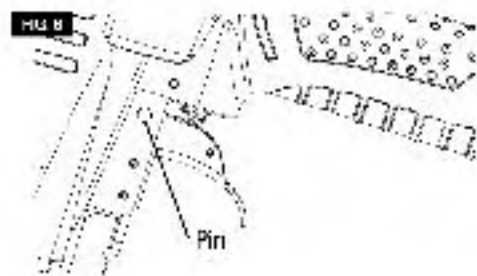

3. Pull the trigger out.
4. Put the red trigger on.
5. Push the trigger pin back, using a small hammer, if necessary.
6. Put the O-ring back to fasten the trigger pin.
7. Reattach the tool to the air supply.
8. Grip the tool firmly to maintain control. Position the nose of the tool onto the work surface.
9. Squeeze and hold the trigger, push the tool against the work surface to depress the work piece contact and drive a nail.

BOUNCE FIRE

1. Pull the trigger with the tool off the work piece.
2. Depress the safety against the work piece to drive a nail.
3. Move the tool along the work piece with a bouncing motion. Each depression of the safety will drive a nail. As soon as the desired number of nails has been driven, remove your finger from the trigger.

NOTE:

- Always handle nails and package carefully. If nails are dropped, the collating bond may be broken, which will cause misfeeding and jamming.
- After nailing:
 1. Disconnect the tool from the air supply.

2. Remove all nails from the tool.
3. Supply 5-10 drops of pneumatic tool lubricant into the air plug on the tool.
4. Open the petcock on the air compressor tank to drain any moisture.

COLD WEATHER OPERATION

WARNING

DO NOT USE A FROZEN TOOL. Allow the tool to thaw before using. Moisture frozen in the tool may impede internal components resulting in the risk of injury and/or tool damage.

When using the tool in cold conditions, the tool will cycle slower than usual while driving the first nails. The cycle rate will increase as the tool warms up. Keep the tool warm to avoid reduced cycle rate.

ADJUSTING THE NAILING DEPTH

WARNING

Disconnect the tool from the air source before making adjustments. Such precautionary measures reduce the risk of unintentional tool operation.

1. Disconnect the tool from the air supply.
2. Remove the nails from the tool.
3. Adjust tool driving depth:
 - To reduce nail depth, turn

the adjustment knob counter clockwise (Fig 7).

- To drive the nail deeper, turn the adjustment knob clockwise (Fig 8).

4. Reload nails as described in the NAIL LOADING section of this manual (pg. 6).

5. Reconnect the air supply.

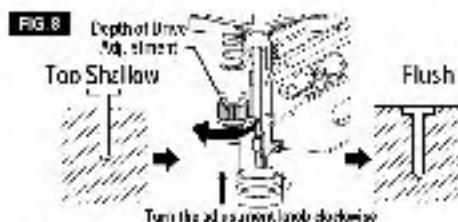
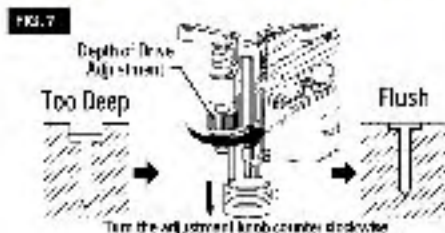

ADJUSTING THE EXHAUST

The direction of the exhaust vent can be changed by turning the top cover (Fig 9).



USING THE NO-MAR TIP (Refer to Figure 10)

WARNING

When attaching or detaching the No-Mar Tip, be sure to remove your finger from the trigger and disconnect the air hose from the nailer.

If you would like to protect the surface of the work piece from scratches or markings made by the safety, attach the No-Mar Tip to the safety.

To replace No-Mar Tip:

1. Disconnect the air hose from the tool.
2. Put the No-Mar Tip to the toe of the safety.

To remove the No-Mar Tip: Pull the No-Mar Tip directly away from the tool.

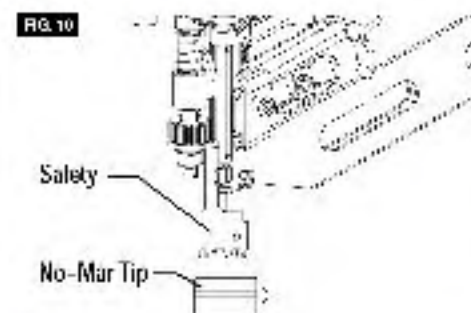

NOTE: The nose cap may reduce nailing depth due to its thickness. Readjustment of nailing depth is required.

MAINTENANCE

JAM CLEARING

If a nail becomes jammed in the tool, disconnect the air hose and keep the tool pointed away from you while clearing the jam.

1. Disconnect the tool from the air supply.
2. Remove all nails.
3. Insert screwdriver into the driving mechanism (Figure 11).
4. Tap the screwdriver gently with a hammer. The inserted screwdriver should push the driver blade back, freeing the nail jam.

5. Remove the bent nail, using needle-nose pliers, if necessary.

6. Reconnect the tool to the air supply.

7. Reload the tool with nails.

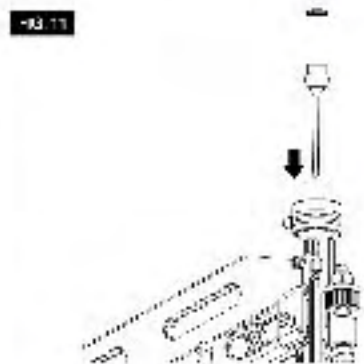

CLEANING

WARNING

When cleaning a tool, be careful not to disassemble any portion of the tool since internal components may be misplaced or safety components may be improperly mounted. Certain cleaning agents such as gasoline, carbon tetrachloride, ammonia, etc. may damage plastic parts and O-rings.

WARNING

Do not attempt to clean by inserting pointed objects through openings in the tool. Sharp edges may damage internal components, causing a serious hazard.

Ventilation openings, the work contact element, and the trigger must be kept clean and free of foreign matter.

Periodically clean the tool with compressed air.

Clean the magazine; remove metal or wooden chips that may have accumulated in the magazine. Periodically clean the magazine with compressed air.

STORAGE

WARNING

Keep out of the reach of children and personnel unfamiliar with the operation of the tool. Lock the storage area. Tools are dangerous in the hands of those unfamiliar with the tool.

When not in use, the tool should be disconnected and locked in a warm, dry place. When tool will not be in use for an extended period of time, apply a thin coat of lubricant to the steel parts to avoid rust.

Do not store the tool in a cold weather environment (see COLD WEATHER OPERATION, pg. 7).

HOOK-UP INSTRUCTIONS FOR TOOL TO AIR SUPPLY

NOTE: For better performance, install a 3/8 inch quick plug (1/4 inch NPT threads) with an inside diameter of 0.315 inch on the nailer and a 3/8 inch quick coupler on the air hose.

1. With the ON/OFF switch in the OFF position, plug the compressor into an electrical outlet.
2. Close the pressure regulator by turning it all the way to the left. Turn the

compressor ON and let it pump all the way up to automatic shut-off pressure.

3. Attach air hose to regulator outlet. Adjust the pressure regulator by turning the knob to the right so that the outlet pressure is between 70 PSI and 115 PSI.

4. Load fasteners into the nailer.

5. Point the nailer in a safe direction while attaching the air hose.

6. Nailer is now ready for use. You may need to adjust the outlet pressure to achieve proper fastener depth.

MINIMUM COMPONENTS REQUIRED FOR HOOK-UP

Air Compressor: The air compressor must be able to maintain a minimum of 70 PSI when the nailer is being used. An adequate air supply can cause a loss of power and inconsistent driving.

Pressure Regulator: A pressure regulator is required to control the operating pressure of the nailer between 70 PSI and 115 PSI.

Air Supply Hose: Always use air supply hoses with a minimum working pressure rating equal to or greater than the pressure from the power source, or 150 PSI, whichever is greater. Use 1/4 inch air hose for runs up to 50 feet and a 3/8 inch air hose for runs 50 feet and longer.

Troubleshooting Guide

Symptom	Possible Cause(s)	Corrective Action
Air Leaking near the top of the tool or in the trigger area	Loose screws	Tighten screws
	Worn or damaged O-rings or seals	Install overhaul kit
Air leaking near the bottom of the tool	Loose screws	Tighten screws
	Worn or damaged O-rings or seals	Install overhaul kit
Tool does nothing or operates sluggishly	Inadequate air supply	Make sure the air compressor is set between 70 PSI and 110 PSI
	Tool is too dry	Add about 2-3 drops of lubrication into the air connector
	Exhaust blocked	Clean exhaust channel
	Worn or damaged O-rings or seals	Install overhaul kit
Fasteners are jammed in the tool frequently	Driver channel is worn	Fix the drive channel
	Piston is broken or worn	Replace the piston
	Bent fasteners	Remove the bent fasteners, replace with the right fasteners
	Dirty magazine	Clean magazine
	Loose magazine	Tighten screws
	Wrong fasteners	Verify that fasteners are the correct size

Limited Manufacturer Warranty

North American Tool (NAT) Industries makes every effort to ensure that this product meets high quality and durability standards. NAT warrants to the original retail consumer a 1-year limited warranty from the date the product was purchased at retail and each product is free from defects in materials.

Warranty does not apply to defects due directly or indirectly to misuse, abuse, negligence or accidents, repairs or alterations, or a lack of maintenance. NAT shall in no event be liable for death, injuries to persons or property, or for incidental, special or consequential damages arising from the use of our products. To receive service under warranty, the original manufacturer part must be returned for examination by an authorized service center. Shipping and handling charges may apply. If a defect is found, NAT will either repair or replace the product at its discretion.

DO NOT RETURN TO STORE

For Customer Service:

Email: feedback@natitools.com or Call 1-800-348-5004



34 DEGREE 3-1/2 INCH CLIPPED HEAD FRAMING NAILER

Parts List

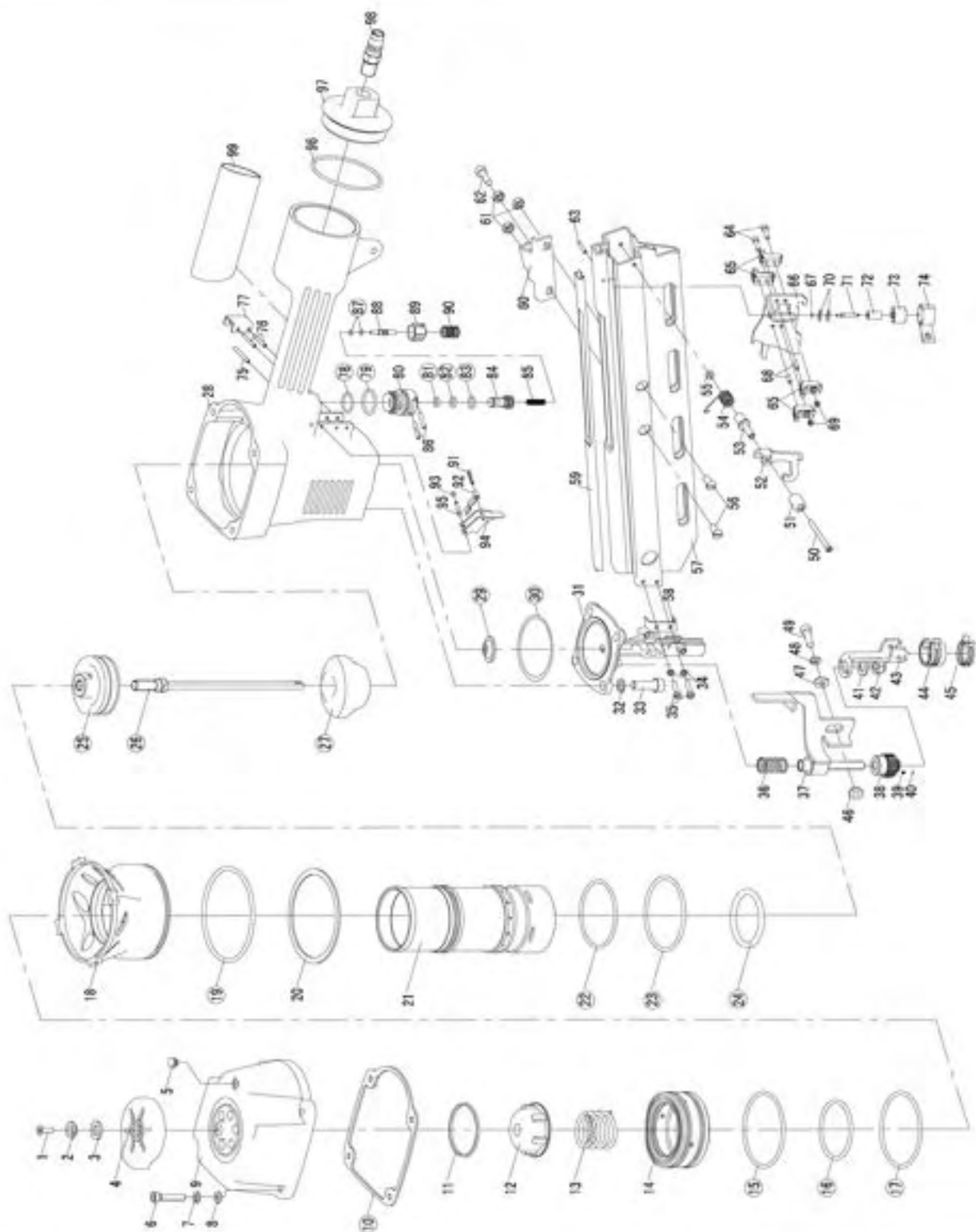

Call 1-800-348-5004 for assistance or replacement parts

Please provide the following information:

- Model number
- Part description and number as shown in parts list
- Serial number (if any)

Address any correspondence to:

North American Tool Industries
84 Commercial Rd
Huntington, IN 46750

No.	Description	QTY
1	Set Screw	1
2	Gasket	1
3	Washer	1
4	Exhaust Cover	1
5	Plastic Washer	1
6	Hex Bolt	4
7	Spring Washer	5
8	Flat Washer	5
9	Air Cap	1
10	Seal	1
11	Iron Ring	1
12	Inner Lining	1
13	Spring	1
14	Head Valve Piston	1
15	Gasket	1
16	O-Ring	1
17	O-Ring	2
18	Collar	1
19	O-Ring	1
20	Iron Ring	1
21	Cylinder	1
22	O-Ring	2
23	Ring	1
24	O-Ring	1
25	Piston	1
26	Driver Blade	1
27	Gasket	1
28	Body	1
29	Gasket	1
30	O-Ring	1

No.	Description	QTY
31	Driver Guide	1
32	Spring Washer	4
33	Hex Bolt	4
34	Spring Washer	2
35	Hex Bolt	2
36	Spring	1
37	Safety	1
38	Regulating Nut	1
39	Spring	2
40	Ball	2
41	Clip	1
42	Nut	1
43	Safety	1
44	No-Mar Tip	1
45	Clip	1
46	Gasket	1
47	Flat Washer	5
48	Spring Washer	5
49	Hex Bolt	2
50	Hex Bolt	1
51	Bushing	1
52	Magazine Latch	1
53	Latch Bushing	1
54	Spring	1
55	Nut	1
56	Screw	2
57	Magazine	1
58	Cover Plate	1
59	Nail Guide	1
60	Tail Hanger	1

Call 1-800-348-5004 for assistance or replacement parts

Please provide the following information:

- Model number
- Part description and number as shown in parts list
- Serial number (if any)

Address any correspondence to:

North American Tool Industries
84 Commercial Rd
Huntington, IN 46750

No.	Description	QTY
61	Nut	3
62	Hex Bolt	2
63	Pin	1
64	Hex Bolt	2
65	Pusher Guide	4
66	Pusher Unit	1
67	Clip	1
68	Pin	2
69	Nut	2
70	Limiting Block	2
71	Spindle	1
72	Bushing	1
73	Plastic Bushing	1
74	Pusher Spring	1
75	Pin	1
76	Pin	2
77	Safety Guide	1
78	O-Ring	1
79	O-Ring	1
80	Trigger Valve Body	1

No.	Description	QTY
81	O-Ring	1
82	O-Ring	1
83	O-Ring	1
84	Trigger Valve Body	1
85	Spring	1
86	Pin	2
87	O-Ring	2
88	Trigger Valve Stem	1
89	Inner Trigger Valve Seat	1
90	Compression Spring	1
91	Pin	1
92	Trigger Plate	1
93	O-Ring	1
94	Trigger	1
95	Pin	1
96	O-Ring	2
97	End Cap	1
98	Air Plug	1
99	Hand Grip	1