

Refrigerated Air Dryers

Series *IDF/IDU*

Standard/High Temperature Air Inlet Type

Protect Pneumatic Equipment from Moisture!

An air dryer removes the vapor from the moist compressed air delivered by the compressor, and prevents it from causing the pneumatic equipment to fail.

Effects of moisture on equipment

Malfunctioning of valves and actuators caused by dripping grease

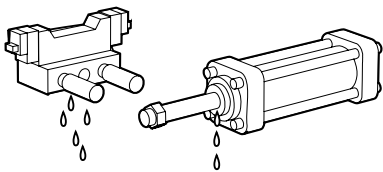

Decomposition of auto drain caused by rusting inside pipes

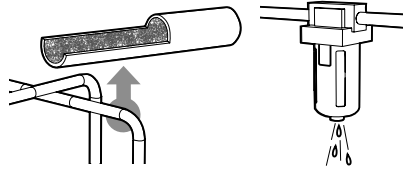

Generation of water droplets



Air flow capacity

Increased up to the
Max. **40** %
(SMC comparison, E type)

Power consumption

Reduced up to the
Max. **40** %
(SMC comparison, E type)

Refrigerant

R134a (HFC) ^{Note)}
R407C (HFC)

Coefficient of destruction for ozone is zero.
Note) Except IDF370B

Improved corrosion resistance with the use of stainless steel, plate type heat exchanger (IDF4E to 75E/IDU3E to 75E)



Standard temperature air inlet [Series *IDF*]

IDF1E, 2E, 3E, 4E, 6E, 8E, 11E, 15E, 22E, 37E, 55E, 75E, 120D, 150D, 190D, 240D, 370B

High temperature air inlet [Series *IDU*]

IDU3E, 4E, 6E, 8E, 11E, 15E, 22E, 37E, 55E, 75E

HAA
HAW

AT

IDF
IDU

IDFA

IDFB

ID

IDG

AMG

AFF

AM

AMD

AMH

AME

AMF

SF

SFD

LLB

AD□

GD

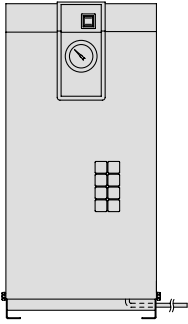

Complies with CFC restrictions

Refrigerated Air Dryers

Series *IDF/IDU*

1. Standard Products

Series IDF

Standard temperature air inlet type
Rated inlet air temperature:
35, 40°C



Model	Rated inlet condition	Air flow capacity (m ³ /min (ANR))		Applicable air compressor (kW)	Refrigerant	Port size	Page
		50 Hz	60 Hz				
IDF1E	35°C, 0.7 MPa	0.1	0.12	0.75	R134a (HFC)	Rc 3/8	P.26 to 29
IDF2E		0.2	0.235	1.5			
IDF3E		0.32	0.37	2.2			
IDF4E		0.52	0.57	3.7		Rc 1/2	
IDF6E		0.75	0.82	5.5			
IDF8E		1.22	1.32	7.5		Rc 3/4	
IDF11E		1.65	1.82	11			
IDF15E		2.8	3.1	15		Rc 1	
IDF22E		3.9	4.3	22		R 1	
IDF37E		5.7	6.1	37		R1 1/2	
IDF55E	40°C, 0.7 MPa	8.4	9.8	55	R407C (HFC)	R 2	
IDF75E		11.0	12.4	75		65 (2 1/2B) flange	
IDF120D		20.0	23.0	120			
IDF150D		25.0	30.0	150		80 (3B) flange	
IDF190D		32.0	38.0	190			
IDF240D		43.0	50.0	240		100 (4B) flange	P.33 to 35
IDF370B	35°C, 0.7 MPa	54.0	65.0	370	R22	150 (6B) flange	

Series IDU

High temperature air inlet type
Rated inlet air temperature:
55°C



Model	Rated inlet condition	Air flow capacity (m ³ /min (ANR))		Applicable air compressor (kW)	Refrigerant	Port size	Page		
		50 Hz	60 Hz						
IDU3E	55°C, 0.7 MPa	0.32	0.37	2.2	R134a (HFC)	Rc 3/8	P.36 to 38		
IDU4E		0.52	0.57	3.7		Rc 1/2			
IDU6E		0.75	0.82	5.5		Rc 3/4			
IDU8E		1.1	1.2	7.5					
IDU11E		1.5	1.7	11		Rc 1			
IDU15E		2.6	2.8	15					
IDU22E		3.9	4.3	22		R 1			
IDU37E		5.7	6.1	37		R1 1/2		P.39 to 41	
IDU55E		8.4	9.8	55		R407C (HFC)			R 2
IDU75E		11.0	12.5	75					

* Refer to pages 59 and 73 for dryer models conforming with foreign standards (CE and UL).

2. Options

Specifications	Applicable model	Model (Suffix: Option symbol)	Page	
Cool compressed air output	IDF1E to 75E	IDF□E-□-A	P.42	
Anti-corrosive treatment	IDF1E to 75E	IDF□E-□-C		
	IDF120D to 240D	IDF□D-□(-□)-C		
	IDF370B	IDF370B-60□-X204		
For medium air pressure (up to 1.6 MPa) (Auto drain bowl: Metal bowl with level gauge)	IDU3E to 75E	IDU□E-□-C		
	IDF6E to 37E	IDF□E-□-K		
With heavy duty auto drain (applicable to medium air pressure)	IDU3E to 15E	IDU□E-□-K		
	IDF4E to 75E	IDF□E-□-L		
	IDF370B	IDF370B-60□-X205		
With motor type auto drain <small>Note 1)</small>	IDU3E to 75E	IDU□E-□-L		P.43
	IDF4E to 75E	IDF□E-□-M		
	IDF120D to 240D	IDF□D-□(-□)-M		
With circuit breaker	IDU3E to 75E	IDU□E-□-M	P.44	
	IDF4E to 75E	IDF□E-□-R		
	IDF120D to 240D	IDF□D-□(-□)-R		
	IDF370B	IDF370B-60□-X202		
Power supply terminal block connection	IDU3E to 75E	IDU□E-□-R	P.45	
	IDF4E to 15E-10	IDF□E-10-S		
With terminal block for power supply, run, alarm signal and remote operation	IDU3E to 15E-10	IDU□E-10-S		
	IDF4E to 75E	IDF□E-□-T		
Timer type solenoid valve with auto drain (applicable to medium air pressure)	IDU3E to 75E	IDU□E-□-T	P.46	
Water-cooled condenser <small>Note 1)</small>	IDF120D to 240D	IDF□D-□(-□)-W		

Note 1) The IDF370B is equipped as standard.

3. Optional Accessories

Description	Page
Separately installed power transformer	P.47 to 54
Dedicated base for separately installed power transformer	
Dust-protecting filter set	
Bypass piping set	
Foundations bolt set	
Piping adapter	

HAA
HAW

AT

IDF
IDU

IDFA

IDFB

ID

IDG

AMG

AFF

AM

AMD

AMH

AME

AMF

SF

SFD

LLB

AD□

GD

Series IDF/IDU

Model Selection

The corrected air flow capacity, which considers the user's operating conditions, is required for selecting the air dryer. Please select using the following procedures.

<p>1 Selecting IDF or IDU</p>	<p>Select IDF or IDU from inlet air temperature used.</p> <ul style="list-style-type: none"> • Inlet air temperature 5 to 50°C IDF • Inlet air temperature 50 to 80°C IDU 																																																																	
<p>2 Reading correction factors</p> <p>Obtain the correction factor A to D suitable for your operating condition from the graph at right.</p>	<table border="1"> <thead> <tr> <th colspan="4">IDF Selection Example</th> </tr> <tr> <th>Condition</th> <th></th> <th>Data symbol</th> <th>Correction Note) factor</th> </tr> </thead> <tbody> <tr> <td>Inlet air temperature</td> <td>40°C</td> <td>A</td> <td>0.82</td> </tr> <tr> <td>Ambient temperature</td> <td>35°C</td> <td>B</td> <td>0.96</td> </tr> <tr> <td>Outlet air pressure dew point</td> <td>10°C</td> <td>C</td> <td>1</td> </tr> <tr> <td>Inlet air pressure</td> <td>0.5 MPa</td> <td>D</td> <td>0.88</td> </tr> <tr> <td>Air flow rate</td> <td>0.3 m³/min</td> <td>—</td> <td>—</td> </tr> <tr> <td>Power supply frequency</td> <td>50 Hz</td> <td>—</td> <td>—</td> </tr> </tbody> </table> <p>Note) Values obtained from "Correction Factors" on page 25.</p>	IDF Selection Example				Condition		Data symbol	Correction Note) factor	Inlet air temperature	40°C	A	0.82	Ambient temperature	35°C	B	0.96	Outlet air pressure dew point	10°C	C	1	Inlet air pressure	0.5 MPa	D	0.88	Air flow rate	0.3 m ³ /min	—	—	Power supply frequency	50 Hz	—	—	<table border="1"> <thead> <tr> <th colspan="4">IDU Selection Example</th> </tr> <tr> <th>Condition</th> <th></th> <th>Data symbol</th> <th>Correction Note) factor</th> </tr> </thead> <tbody> <tr> <td>Inlet air temperature</td> <td>60°C</td> <td>A</td> <td>0.95</td> </tr> <tr> <td>Ambient temperature</td> <td>35°C</td> <td>B</td> <td>0.93</td> </tr> <tr> <td>Outlet air pressure dew point</td> <td>10°C</td> <td>C</td> <td>1</td> </tr> <tr> <td>Inlet air pressure</td> <td>0.5 MPa</td> <td>D</td> <td>0.88</td> </tr> <tr> <td>Air flow rate</td> <td>0.4 m³/min</td> <td>—</td> <td>—</td> </tr> <tr> <td>Power supply frequency</td> <td>60 Hz</td> <td>—</td> <td>—</td> </tr> </tbody> </table> <p>Note) Values obtained from "Correction Factors" on page 25.</p>	IDU Selection Example				Condition		Data symbol	Correction Note) factor	Inlet air temperature	60°C	A	0.95	Ambient temperature	35°C	B	0.93	Outlet air pressure dew point	10°C	C	1	Inlet air pressure	0.5 MPa	D	0.88	Air flow rate	0.4 m ³ /min	—	—	Power supply frequency	60 Hz	—	—
IDF Selection Example																																																																		
Condition		Data symbol	Correction Note) factor																																																															
Inlet air temperature	40°C	A	0.82																																																															
Ambient temperature	35°C	B	0.96																																																															
Outlet air pressure dew point	10°C	C	1																																																															
Inlet air pressure	0.5 MPa	D	0.88																																																															
Air flow rate	0.3 m ³ /min	—	—																																																															
Power supply frequency	50 Hz	—	—																																																															
IDU Selection Example																																																																		
Condition		Data symbol	Correction Note) factor																																																															
Inlet air temperature	60°C	A	0.95																																																															
Ambient temperature	35°C	B	0.93																																																															
Outlet air pressure dew point	10°C	C	1																																																															
Inlet air pressure	0.5 MPa	D	0.88																																																															
Air flow rate	0.4 m ³ /min	—	—																																																															
Power supply frequency	60 Hz	—	—																																																															
<p>3 Confirmation of coefficient</p>	<p>Correction factor = 0.82 x 0.96 x 1 x 0.88 = 0.69 Max. coefficient value is 1.5. Correction factor is 1.5 when the calculation result is 1.5 or greater.</p>																																																																	
<p>4 Calculating corrected air flow capacity</p> <p>Obtain the corrected air flow capacity from the following formula. Corrected air flow capacity = Operating air flow capacity ÷ (Correction factor A x B x C x D)</p>	<p>Corrected air flow capacity = 0.3 m³/min ÷ (0.82 x 0.96 x 1 x 0.88) = 0.43 m³/min</p>	<p>Corrected air flow capacity = 0.4 m³/min ÷ (0.95 x 0.93 x 1 x 0.88) = 0.51 m³/min</p>																																																																
<p>5 Selecting a model</p> <p>Select a model which corrected air flow capacity exceeds the air flow capacity from the specification table. (For air flow capacity, refer to the data E on page 25.)</p>	<p>According to the corrected air flow capacity of 0.43 m³/min, the IDF4E will be selected which air flow capacity is 0.52 m³/min at 50 Hz.</p> <p>According to the corrected air flow capacity of 0.51 m³/min, the IDU4E will be selected which air flow capacity is 0.57 m³/min at 60 Hz.</p>																																																																	
<p>6 Options</p>	<p>Refer to pages 42 through to 46.</p>																																																																	
<p>7 Model selected</p>	<p>Refer to pages 26, 30 and 33.</p>																																																																	
<p>8 Selecting optional accessories</p>	<p>Refer to pages 47 through to 54.</p>																																																																	

Correction Factors

Data A: Inlet Air Temperature

Series IDF

IDF1E to 37E

Inlet air temp. (°C)	Correction factor
5 to 30	1.3
35	1
40	0.82
45	0.68
50	0.57

IDF55E, 75E, 120D to 240D

Inlet air temp. (°C)	Correction factor
5 to 30	1.35
35	1.25
40	1
45	0.8
50	0.6

IDF370B

Inlet air temp. (°C)	Correction factor
5 to 30	1.25
35	1.00
40	0.83
45	0.70
50	0.60

Series IDU

IDU3E to IDU37E

Inlet air temp. (°C)	Correction factor
5 to 45	1.15
50	1.07
55	1
60	0.95
65	0.9
70	0.86
75	0.82
80	0.79

IDU55E, 75E

Inlet air temp. (°C)	Correction factor
5 to 45	1.21
50	1.10
55	1
60	0.87
65	0.76
70	0.74
75	0.72
80	0.70

Data B: Ambient Temperature

Series IDF

IDF1E to 75E

Ambient temp. (°C)	Correction factor
2 to 25	1.14
30	1.04
32	1
35	0.96
40	0.9

IDF120D to 240D

Ambient temp. (°C)	Correction factor
2 to 25	1.10
30	1.05
32	1
35	0.95
40	0.90

Series IDU

IDU3E to IDU37E

Ambient temp. (°C)	Correction factor
2 to 25	1.2
30	1.04
32	1
35	0.93
40	0.84

IDU55E, 75E

Ambient temp. (°C)	Correction factor
2 to 25	1.25
30	1.11
32	1
35	0.90
40	0.63

Data C: Outlet Air Pressure Dew Point

Series IDF

IDF1E to 75E, 120D to 240D, 370B

Outlet air pressure dew point (°C)	Correction factor
3	0.55
5	0.7
10	1
15	1.3

Series IDU

IDU3E to IDU37E

Outlet air pressure dew point (°C)	Correction factor
3	0.55
5	0.7
10	1
15	1.3

IDU55E, 75E

Outlet air pressure dew point (°C)	Correction factor
3	0.53
5	0.67
10	1
15	1.30

Data D: Inlet Air Pressure

Series IDF

IDF1E to 75E

Inlet air pressure (MPa)	Correction factor
0.2	0.62
0.3	0.72
0.4	0.81
0.5	0.88
0.6	0.95
0.7	1
0.8	1.06
0.9	1.11
1 to 1.6	1.16

IDF120D to 370B

Inlet air pressure (MPa)	Correction factor
0.2	0.68
0.3	0.77
0.4	0.84
0.5	0.90
0.6	0.95
0.7	1
0.8	1.03
0.9	1.06
1.0	1.08

Series IDU

IDU3E to 37E

Inlet air pressure (MPa)	Correction factor
0.2	0.62
0.3	0.72
0.4	0.81
0.5	0.88
0.6	0.95
0.7	1
0.8	1.06
0.9	1.11
1 to 1.6	1.16

IDU55E, 75E

Inlet air pressure (MPa)	Correction factor
0.2	0.62
0.3	0.69
0.4	0.77
0.5	0.85
0.6	0.93
0.7	1
0.8	1.08
0.9	1.16
1 to 1.6	1.23

Data E: Air Flow Capacity

Series IDF

Model	IDF1E	IDF2E	IDF3E	IDF4E	IDF6E	IDF8E	IDF11E	IDF15E	IDF22E	IDF37E	IDF55E	IDF75E
Air flow capacity 50 Hz	0.10	0.20	0.32	0.52	0.75	1.22	1.65	2.8	3.9	5.7	8.4	11.0
m ³ /min (ANR) 60 Hz	0.12	0.235	0.37	0.57	0.82	1.32	1.82	3.1	4.3	6.1	9.8	12.4

Model	IDF120D	IDF150D	IDF190D	IDF240D	IDF370B
Air flow capacity 50 Hz	20.0	25.0	32.0	43.0	54.0
m ³ /min (ANR) 60 Hz	23.0	30.0	38.0	50.0	65.0

Note) In the case of option A (Cool compressed air output), the air flow capacity is different. Refer to page 42 for details.

Series IDU

Model	IDU3E	IDU4E	IDU6E	IDU8E	IDU11E	IDU15E	IDU22E	IDU37E	IDU55E	IDU75E
Air flow capacity 50 Hz	0.32	0.52	0.75	1.1	1.5	2.6	3.9	5.7	8.4	11.0
m ³ /min (ANR) 60 Hz	0.37	0.57	0.82	1.2	1.7	2.8	4.3	6.1	9.8	12.5

- HAA
- HAW
- AT
- IDF
- IDU
- IDFA
- IDFB
- ID
- IDG
- AMG
- AFF
- AM
- AMD
- AMH
- AME
- AMF
- SF
- SFD
- LLB
- AD
- GD

Refrigerant R134a (HFC) High Temperature Air Inlet Series **IDU** **E**

3E, 4E, 6E, 8E, 11E, 15E

(Inlet air temperature: 55°C, Outlet air pressure dew point: 10°C)

How to Order

IDU 4 E — 10 —

Nil
C
K
L
M
R
S
T
V

Size ●

Size	Air compressor size ^{Note)}
3	2.2 kW
4	3.7 kW
6	5.5 kW
8	7.5 kW
11	11 kW
15	15 kW

Note) Please note that the above values are for reference only. Therefore, check the actual compressor capacity.

Voltage ●

Symbol	Voltage	Applicable size					
		3	4	6	8	11	15
10	Single-phase 100 VAC (50 Hz)	●	●	●	●	●	●
	100/110 VAC (60 Hz)						
20	Single-phase 200 VAC (50 Hz)	●	●	●	●	●	●
	200/220 VAC (60 Hz)						
23	Single-phase 230 VAC (50 Hz)	●	●	●	●	●	●

Option ●

Symbol ^{Note 1)}	Nil	C	K	L	M	R	S	T	V
Option	None	Anti-corrosive treatment	For medium air pressure (Auto drain bowl: Metal bowl with level gauge)	With heavy duty auto drain (applicable to medium air pressure)	With motor type auto drain (Voltage symbol 10, 20 only)	With circuit breaker	Terminal block connection (Voltage symbol 10 only) ^{Note 2)}	With terminal block for run and alarm signal	Timer type solenoid valve with auto drain (Voltage symbol 23 only) (applicable to medium air pressure)
Size									
3	●	●	●	●	●	●	●	●	●
4	●	●	●	●	●	●	●	●	●
6	●	●	●	●	●	●	●	●	●
8	●	●	●	●	●	●	●	●	●
11	●	●	●	●	●	●	●	●	●
15	●	●	●	— ^{Note 4)}	●	●	●	●	●

Note 1) Enter alphabetically when multiple options are combined.

However, the following combinations are not possible.

- R and S (Because S function is also included in R.)
- S and T (Because S function is also included in T.)
- Combination of K, L, M and V are not possible because an auto drain can only be attached to a single option.

Note 2) Voltage symbol 20 (200 VAC) and 23 (230 VAC) are the terminal block connection as standard. The option S cannot be chosen.

Voltage symbol 10 (100 VAC) is the power cable with plug as standard.

Note 3) Refer to pages 42 through to 46 for further information on options.

Note 4) The mounting frame (special order) for the IDU15E is attached to the option L. For further details, please consult with SMC.

Standard Specifications

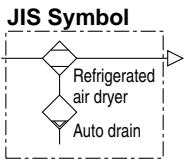

Specifications		Model						
		IDU3E	IDU4E	IDU6E	IDU8E	IDU11E	IDU15E	
Operating ranges	Fluid	Compressed air						
	Inlet air temperature (°C)	5 to 80						
	Inlet air pressure (MPa)	0.15 to 1.0						
	Ambient temp. (humidity) (°C)	2 to 40 (Relative humidity of 85% or less)						
Air flow capacity (m ³ /min)	Standard condition (ANR) <small>Note 1)</small>	50 Hz	0.32	0.52	0.75	1.1	1.5	2.6
		60 Hz	0.37	0.57	0.82	1.2	1.7	2.8
	Compressor intake condition <small>Note 2)</small>	50 Hz	0.33	0.54	0.78	1.14	1.6	2.7
		60 Hz	0.38	0.59	0.85	1.25	1.8	2.9
Rated conditions <small>Note 3)</small>	Inlet air pressure (MPa)	0.7						
	Inlet air temperature (°C)	55						
	Ambient temperature (°C)	32						
	Outlet air pressure dew point (°C)	10						
Electric specifications	Power supply voltage (frequency) <small>Note 4)</small>	Single-phase: 100 VAC (50 Hz), 100/110 VAC (60 Hz) <small>Note 4)</small> Single-phase: 200 VAC (50 Hz), 200/220 VAC (60 Hz) Single-phase: 230 VAC ±10% (50 Hz)						
	Power consumption (W) 50/60 Hz	Single-phase 100 V	180/202	208/236	385/440	250/290 <small>Note 5)</small>	425/470 <small>Note 5)</small>	585/685 <small>Note 5)</small>
		Single-phase 200 V						
		Single-phase 230 V (50 Hz)	210	220	400	260	425	550
	Operating current (A) 50/60 Hz	100 V	2.4/2.5	3.0/3.1	5.7/5.7	3.4/3.5	5.7/6.0	6.2/6.3
200 V		1.2/1.3	1.5/1.5	3.4/3.0	1.7/1.7	3.5/3.2	4.1/4.0	
230 V (50 Hz)		1.5	1.6	2.9	1.7	3.0	3.4	
Applicable circuit breaker capacity <small>Note 6)</small> (A)	10 (100 VAC), 5 (200 VAC, 230 VAC)						10 (100 VAC) 10 (200 VAC)	
Refrigerant	R134a (HFC)							
Auto drain	Float type (Normally open)							
Port size	Rc 3/8	Rc 1/2	Rc 3/4			Rc 1		
Mass (kg)	23	27	28	44	47	71		
Coating color	Body panel: White 1 Base: Gray 2							
Applicable air compressor output (Reference) For screw type (kW)	2.2	3.7	5.5	7.5	11	15		

Note 1) Air flow capacity under the standard condition (ANR) [atmospheric pressure at 20°C, relative humidity at 65%]
 Note 2) Air flow capacity converted by the compressor intake condition [atmospheric pressure at 32°C]
 Note 3) Select air dryer according to "Model Selection" (pages 24 and 25) for the models beyond the rated specifications.
 Note 4) When selecting a power supply voltage, refer to "How to Order" on page 36.
 Note 5) For the models IDU8E or larger, the energy saving function is performed by the addition of an aftercooler.
 Note 6) Install a circuit breaker with a sensitivity of 30 mA.

Replacement Parts

Model	IDU3E	IDU4E	IDU6E	IDU8E	IDU11E	IDU15E
Auto drain replacement parts no. <small>Note 7)</small>	AD48				AMG-CA450-D	

Note 7) The part number for the auto drain components without including the body part.
 Body part replacement is impossible.

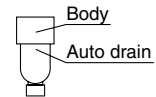

Construction Principle (Air/Refrigerant Circuit)

Humid, hot air coming into the air dryer will be cooled down by a heat exchanger. Water condensed at this time will be removed from the air by a drain separator and drained out automatically. Air separated from the water will be heated by a heat exchanger to obtain the dried air, which goes through to the outlet side.
 For models IDU8E to 15E, the humid and hot air introduced to the air dryer will be cooled down by the aftercooler before being cooled down by the heat exchanger.

IDU3E, IDU4E, IDU6E

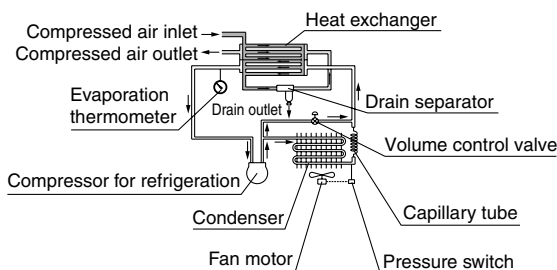

IDU8E, IDU11E, IDU15E

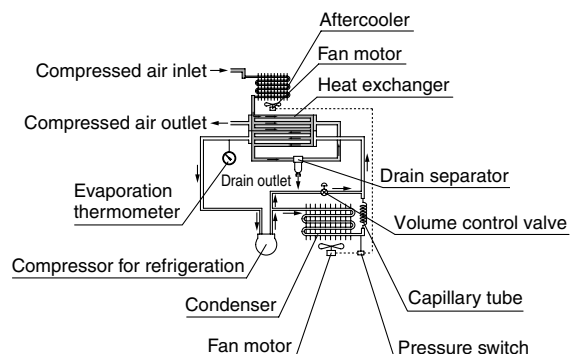

Series IDU□E

Dimensions

IDU3E to IDU6E

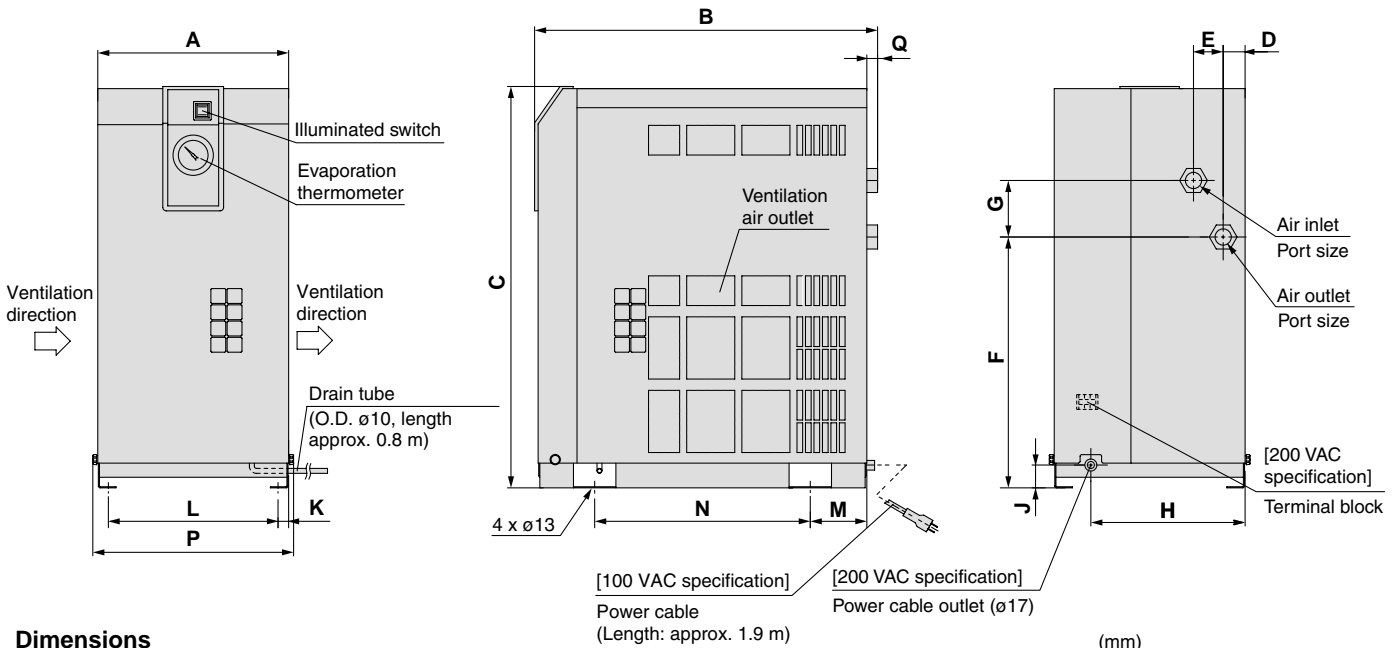

Dimensions

Model	Port size	A	B	C	D	E	F	G	H	J	K	L	M	N	P	Q
IDU3E	Rc 3/8	270	455	498	31	42	283	80	230	32	15	240	80	275	284	15
IDU4E	Rc 1/2		483	568			355							300		13
IDU6E	Rc 3/4		485	300			15									

IDU8E to IDU15E

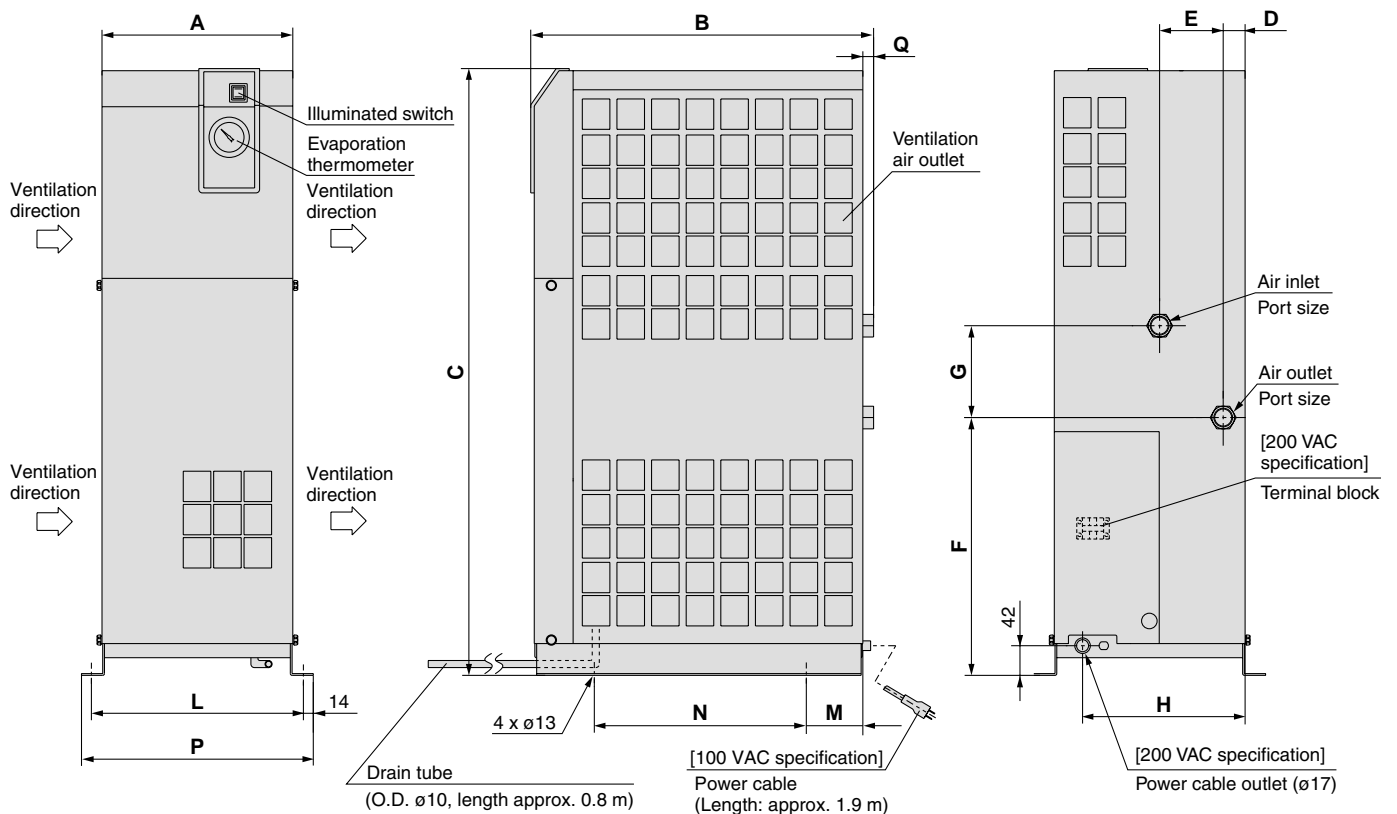

Dimensions

Model	Port size	A	B	C	D	E	F	G	H	L	M	N	P	Q
IDU8E	Rc 3/4	270	485	859	31	90	365	130	230	300	80	300	328	15
IDU11E				909										
IDU15E	Rc 1	300	620	960	79	54	425	93	258	330	66	470	358	16

Refrigerant R407C (HFC) High Temperature Air Inlet Series **IDU**□**E**

22E, 37E, 55E, 75E

(Inlet air temperature: 55°C, Outlet air pressure dew point: 10°C)

How to Order

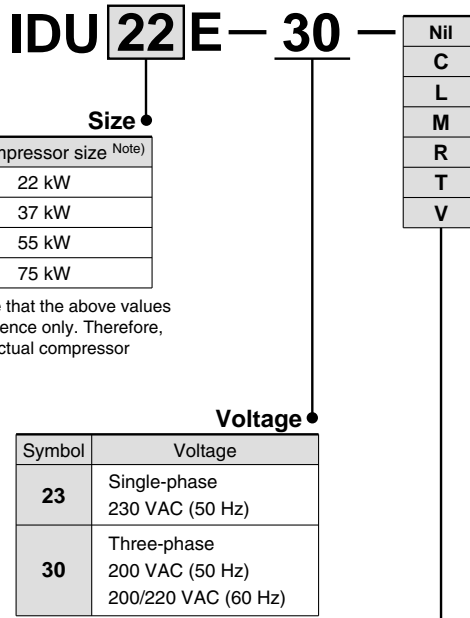

Symbol ^{Note 1)}	Nil	C	L	M	R	T	V
Option	None	Anti-corrosive treatment	With heavy duty auto drain (applicable to medium air pressure)	With motor type auto drain (Voltage symbol 30 only)	With circuit breaker	With terminal block for run and alarm signal	Timer type solenoid valve with auto drain (Voltage symbol 23 only) (applicable to medium air pressure)
Size							
22	●	●	●	●	●	●	●
37	●	●	●	●	●	●	●
55	●	●	●	●	●	●	●
75	●	●	●	●	●	●	●

Note 1) Enter alphabetically when multiple options are combined.

However, the following combinations are not possible.

- Combination of L, M and V are not possible because an auto drain can only be attached to a single option.

Note 2) Refer to pages 42 through to 45 for further information on options.

HAA
HAW

AT

IDF
IDU

IDFA

IDFB

ID

IDG

AMG

AFF

AM

AMD

AMH

AME

AMF

SF

SFD

LLB

AD□

GD

Standard Specifications



JIS Symbol

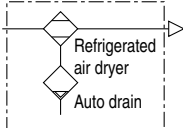

Specifications		Model	High temperature air inlet				
		IDU22E	IDU37E	IDU55E	IDU75E		
Operating ranges	Fluid	Compressed air					
	Inlet air temperature (°C)	5 to 80					
	Inlet air pressure (MPa)	0.15 to 1.0					
	Ambient temp. (humidity) (°C)	2 to 40 (Relative humidity of 85% or less)					
Operating conditions (Note 3)	Air flow capacity (m ³ /min)	Standard condition (ANR) (Note 1)	50 Hz	3.9	5.7	8.4	11.0
		60 Hz	4.3	6.1	9.8	12.5	
	Compressor intake condition (Note 2)	50 Hz	4.1	5.9	8.7	11.5	
		60 Hz	4.5	6.4	10.2	13.0	
	Inlet air pressure (MPa)		0.7				
	Inlet air temperature (°C)		55				
Ambient temperature (°C)		32					
Outlet air pressure dew point (°C)		10					
Electric specifications	Power supply voltage (frequency)		Three-phase: 200 VAC (50 Hz) Three-phase: 200/220 VAC (60 Hz)				
	Power consumption (W) 50/60 Hz	Three-phase 200 V	1100/1450		1530/2000	2200/2850	
		Single-phase 230 V (50 Hz)	960	1600		2300	
	Operating current (A) 50/60 Hz	Three-phase 200 V	4.2/4.8		6.3/6.8	8.2/9.3	
		Single-phase 230 V (50 Hz)	4.3	7.5		10.7	
	Applicable circuit breaker (A) capacity (Note 4)		Three-phase 200 V	10		15	
Single-phase 230 V (50 Hz)		10		20	20		
Refrigerant		R407C (HFC)					
Auto drain		Float type (Normally open)					
Port size		R 1	R 1 1/2	R 2			
Mass (kg)		90	130	160	166		
Coating color		Body panel: White 1 Base: Gray 2					
Applicable air compressor output (Reference) For screw type (kW)		22	37	55	75		

Note 1) Air flow capacity under the standard condition (ANR) [atmospheric pressure at 20°C, relative humidity at 65%]

Note 2) Air flow capacity converted by the compressor intake condition [atmospheric pressure at 32°C]

Note 3) Select air dryer according to "Model Selection" (pages 24 and 25) for the models beyond the rated specifications.

Note 4) Install a circuit breaker with a sensitivity of 30 mA.

Replacement Parts

Model	IDU22E	IDU37E	IDU55E	IDU75E
Auto drain replacement parts no. (Note 5)	AD48			

Note 5) The part number for the auto drain components without including the body part.
Body part replacement is impossible.

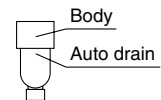

Construction Principle (Air/Refrigerant Circuit)

Humid, hot air coming into the air dryer will be cooled down by a heat exchanger. Water condensed at this time will be removed from the air by a drain separator and drained out automatically. Air separated from the water will be heated by a heat exchanger to obtain the dried air, which goes through to the outlet side.

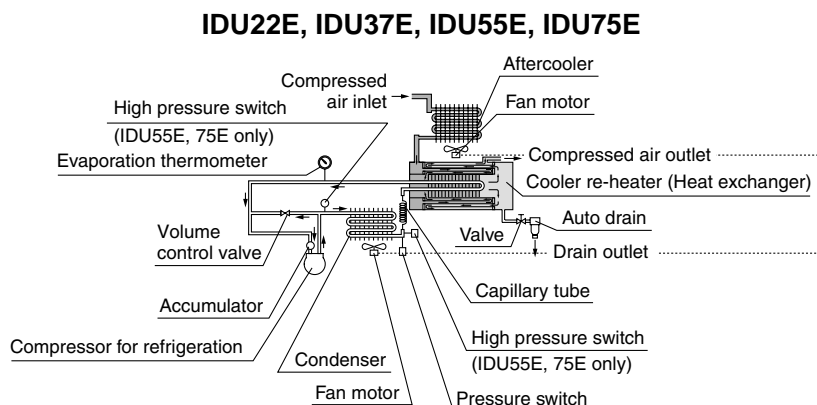

Dimensions

IDU22E to 75E

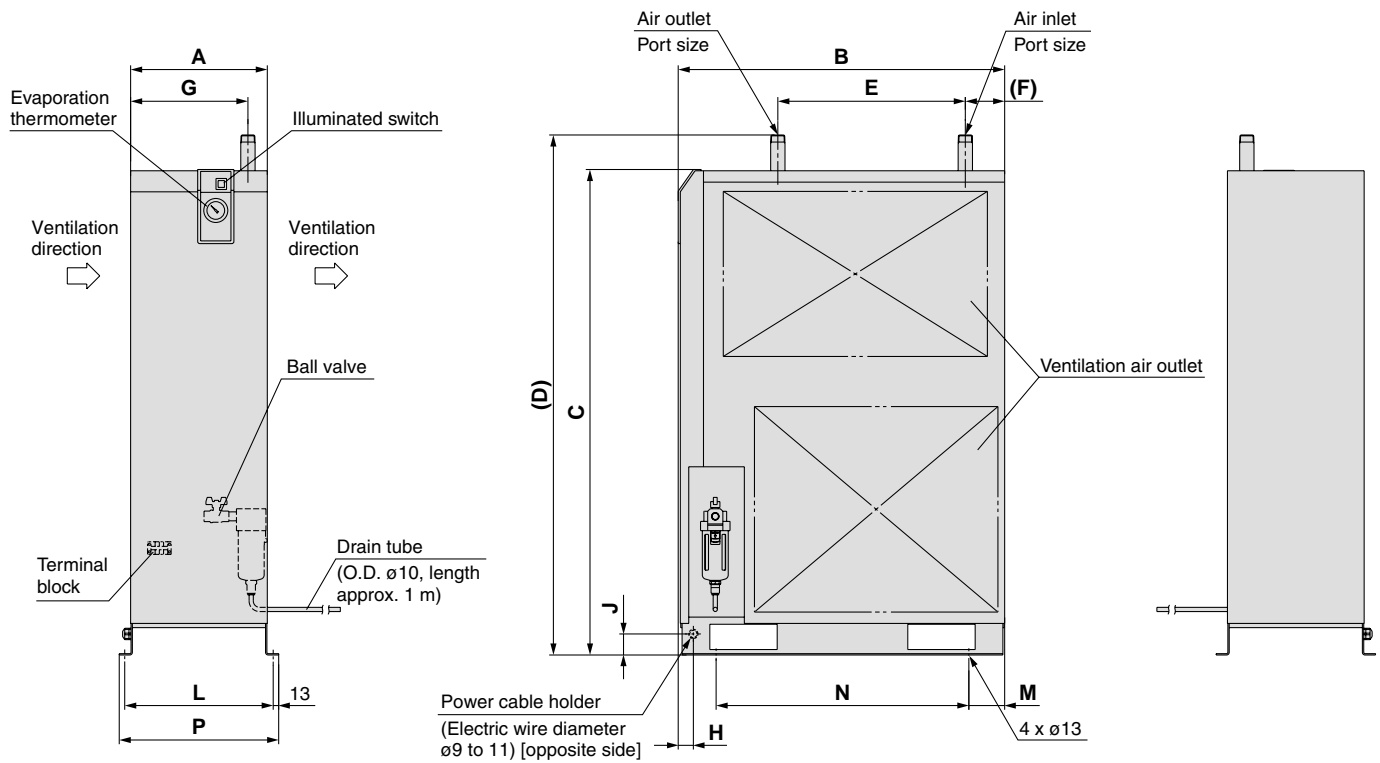

Dimensions

(mm)

Model	Port size	A	B	C	D	E	F	G	H	J	L	M	N	P
IDU22E	R 1	325	775	1153	1235	445	93	279	46	50	353	85	600	379
IDU37E	R 1 1/2	360		1258	1350	550	64	290			388			680
IDU55E	R 2	470	855	1345	1440	530	53	360	30	70	500	75	700	526
IDU75E				1480	1575									

- HAA
- HAW
- AT
- IDF**
- IDU**
- IDFA
- IDFB
- ID
- IDG
- AMG
- AFF
- AM
- AMD
- AMH
- AME
- AMF
- SF
- SFD
- LLB
- AD□
- GD



Series IDF/IDU Specific Product Precautions 1

Be sure to read before handling. Refer to front matters 42 and 43 for Safety Instructions and pages 6 to 8 for Air Preparation Equipment Precautions.

Installation

⚠ Caution

- Avoid locations where the air dryer will be in direct contact with wind and rain. (Places where relative humidity is greater than 85%)
- Avoid exposure to direct sunlight.
- Avoid locations that contain much dust, corrosive gases, or flammable gases. Failure due to corrosion is not covered under warranty. However, when the risk of corrosion is high, select the option C (copper tubing with anti-corrosive treatment).
- Avoid locations of poor ventilation and high temperature.
- Avoid locations where the air dryer is too close to a wall, etc. Leave sufficient room between the dryer and the wall according to the "Maintenance Space" in the operating manual.
- Avoid locations where the air dryer could draw in high temperature air that is discharged from an air compressor or other dryer.

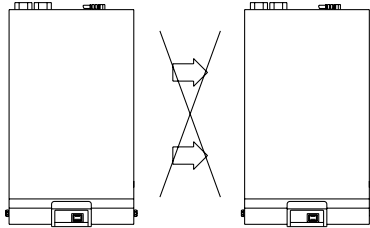

The exhaust air should not flow into the neighboring equipment.

- Avoid locations subjected to vibration.
- Avoid possible locations where the drain can freeze.
- Use the air dryer with an ambient temperature lower than 40°C.
- Avoid installation on machines for transporting, such as vehicles, ships, etc.

Drain Tube

⚠ Caution

- A polyurethane tube is attached as a drain tube for the IDF1E to 75E, IDU3E to 75E. Use this tube to discharge drainage.
- Do not use the drain tube in an upward direction. Do not bend or crush the drain tube. (Operation of the auto drain will stop water vapor from discharging through the air outlet.)
If it is unavoidable that the tube goes upwards, make sure it only goes as far as the position of the auto drain.

Power Supply

⚠ Caution

<100 VAC>

- Insert the power supply plug to an exclusive 100 VAC power outlet.
 - Install a circuit breaker ^{Note 1)} suitable to each model for the power supply.
 - The voltage fluctuation should be maintained within $\pm 10\%$ of the rated voltage.
 - Be sure to ground the power supply prior to use.
 - Multiple-branch wiring is dangerous since it causes overheating.
 - Do not extend the power cable by using a table tap, etc. A voltage drop may cause the air dryer to stop operating.
- Note 1) Select a circuit breaker having a sensitivity current of 30 mA and a rated current of 10 A.

<200 VAC>

- Connect the power supply to the terminal block.
 - Install a circuit breaker ^{Note 2)} suitable to each model for the power supply.
 - The voltage fluctuation should be maintained within $\pm 10\%$ of the rated voltage.
- Note 2) Select a circuit breaker with a sensitivity current of 30 mA. As regards rated current, refer to "Applicable circuit breaker capacity" on pages 27, 31, 34, 37 and 40.

When the voltage used is different than specified for a standard product, use a separately installed power transformer. (page 47)

HAA
HAW

AT

IDF
IDU

IDFA

IDFB

ID

IDG

AMG

AFF

AM

AMD

AMH

AME

AMF

SF

SFD

LLB

AD□

GD



Series IDF/IDU Specific Product Precautions 2

Be sure to read before handling. Refer to front matters 42 and 43 for Safety Instructions and pages 6 to 8 for Air Preparation Equipment Precautions.

Air Piping

Caution

- Be careful to avoid an error in connecting the air piping at the compressed air inlet (IN) and outlet (OUT).
- Install bypass piping since it is needed for maintenance.

Use the bypass piping set on pages 53 and 54.

IDF1E to 3E

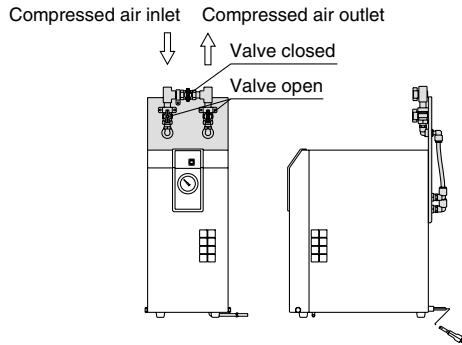

IDF4E to 15E IDU3E to 15E

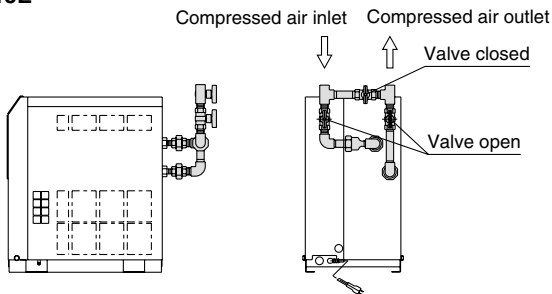

IDF22E, 37E IDU22E to 75E

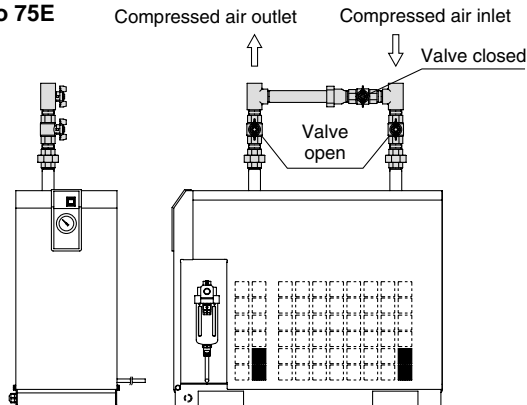

IDF55E, 75E

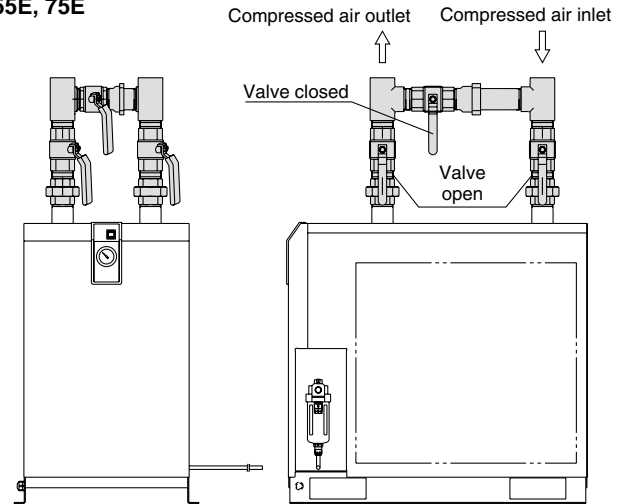

- When tightening the inlet/outlet air piping, firmly hold the hexagonal parts of the port on the air dryer side or piping with a spanner or adjustable angle wrench.
- Variations in operating conditions may cause condensation to form at the surface of the outlet piping. Apply thermal insulation around the piping to prevent condensation from forming.
- Vibration resulting from the compressor should not be transmitted through air piping to the air dryer.
- Do not allow the weight of the piping to lie directly on the air dryer.



Series IDF/IDU Specific Product Precautions 3

Be sure to read before handling. Refer to front matters 42 and 43 for Safety Instructions and pages 6 to 8 for Air Preparation Equipment Precautions.

Protection Circuit

Caution

When the air dryer is operated under the following stated conditions, a protection circuit is activated, the light turns off and operation stops.

- When the compressed air temperature is too high.
- When the compressed air flow rate is too high.
- When the ambient temperature is too high. (40°C or higher)
- When the fluctuation of the power supply is beyond the rated voltage $\pm 10\%$.
- When the air dryer is drawing in high temperature air that is exhausted from an air compressor or other dryer.
- The ventilation port is obstructed by a wall or clogged with dust.

Compressor Air Delivery

Caution

Use an air compressor with an air delivery of 100 ℓ/min or larger for the IDF2E, 3E and the IDU3E, 4E.

Since the auto drain of the IDF2E to 75E, IDU3E to 75E is designed in such a way that the valve remains open unless the air pressure rises to 0.1 MPa or higher, air will blow out from the drain discharge port at the time of air compressor start up until the pressure increases. Therefore, if an air compressor has a small air delivery, the pressure may not be sufficient.

Auto Drain

Caution

The auto drain may not function properly, depending on the quality of the compressed air. Check the operation once a day.

Cleaning of Ventilation Area

Caution

Remove dust from the ventilation area once a month using a vacuum cleaner or an air blow nozzle.

Time Delay for Restarting

Caution

Allow at least three minutes before restarting the dryer. If the air dryer is restarted within three minutes after being stopped, the protection circuit will be activated, operating light turns off and the dryer will not be activated.

Modifying the Standard Specifications

Caution

Do not modify the standard product using any of the optional specifications once the product has been supplied to a customer. Check the specifications carefully before selecting an air dryer.

HAA
HAW

AT

IDF
IDU

IDFA

IDFB

ID

IDG

AMG

AFF

AM

AMD

AMH

AME

AMF

SF

SFD

LLB

AD□

GD

Safety Instructions

These safety instructions are intended to prevent hazardous situations and/or equipment damage. These instructions indicate the level of potential hazard with the labels of “**Caution**,” “**Warning**” or “**Danger**.” They are all important notes for safety and must be followed in addition to International Standards (ISO/IEC)*1, and other safety regulations.

 **Caution:** **Caution** indicates a hazard with a low level of risk which, if not avoided, could result in minor or moderate injury.

 **Warning:** **Warning** indicates a hazard with a medium level of risk which, if not avoided, could result in death or serious injury.

 **Danger :** **Danger** indicates a hazard with a high level of risk which, if not avoided, will result in death or serious injury.

- *1) ISO 4414: Pneumatic fluid power – General rules relating to systems.
ISO 4413: Hydraulic fluid power – General rules relating to systems.
IEC 60204-1: Safety of machinery – Electrical equipment of machines.
(Part 1: General requirements)
ISO 10218-1: Manipulating industrial robots – Safety.
etc.

Warning

1. The compatibility of the product is the responsibility of the person who designs the equipment or decides its specifications.

Since the product specified here is used under various operating conditions, its compatibility with specific equipment must be decided by the person who designs the equipment or decides its specifications based on necessary analysis and test results. The expected performance and safety assurance of the equipment will be the responsibility of the person who has determined its compatibility with the product. This person should also continuously review all specifications of the product referring to its latest catalog information, with a view to giving due consideration to any possibility of equipment failure when configuring the equipment.

2. Only personnel with appropriate training should operate machinery and equipment.

The product specified here may become unsafe if handled incorrectly. The assembly, operation and maintenance of machines or equipment including our products must be performed by an operator who is appropriately trained and experienced.

3. Do not service or attempt to remove product and machinery/equipment until safety is confirmed.

1. The inspection and maintenance of machinery/equipment should only be performed after measures to prevent falling or runaway of the driven objects have been confirmed.
2. When the product is to be removed, confirm that the safety measures as mentioned above are implemented and the power from any appropriate source is cut, and read and understand the specific product precautions of all relevant products carefully.
3. Before machinery/equipment is restarted, take measures to prevent unexpected operation and malfunction.

4. Contact SMC beforehand and take special consideration of safety measures if the product is to be used in any of the following conditions.

1. Conditions and environments outside of the given specifications, or use outdoors or in a place exposed to direct sunlight.
2. Installation on equipment in conjunction with atomic energy, railways, air navigation, space, shipping, vehicles, military, medical treatment, combustion and recreation, or equipment in contact with food and beverages, emergency stop circuits, clutch and brake circuits in press applications, safety equipment or other applications unsuitable for the standard specifications described in the product catalog.
3. An application which could have negative effects on people, property, or animals requiring special safety analysis.
4. Use in an interlock circuit, which requires the provision of double interlock for possible failure by using a mechanical protective function, and periodical checks to confirm proper operation.

Caution

1. The product is provided for use in manufacturing industries.

The product herein described is basically provided for peaceful use in manufacturing industries.

If considering using the product in other industries, consult SMC beforehand and exchange specifications or a contract if necessary.

If anything is unclear, contact your nearest sales branch.

Limited warranty and Disclaimer/ Compliance Requirements

The product used is subject to the following “Limited warranty and Disclaimer” and “Compliance Requirements”.

Read and accept them before using the product.

Limited warranty and Disclaimer

1. The warranty period of the product is 1 year in service or 1.5 years after the product is delivered, whichever is first.*2)
Also, the product may have specified durability, running distance or replacement parts. Please consult your nearest sales branch.
2. For any failure or damage reported within the warranty period which is clearly our responsibility, a replacement product or necessary parts will be provided.
This limited warranty applies only to our product independently, and not to any other damage incurred due to the failure of the product.
3. Prior to using SMC products, please read and understand the warranty terms and disclaimers noted in the specified catalog for the particular products.

*2) Vacuum pads are excluded from this 1 year warranty.

A vacuum pad is a consumable part, so it is warranted for a year after it is delivered. Also, even within the warranty period, the wear of a product due to the use of the vacuum pad or failure due to the deterioration of rubber material are not covered by the limited warranty.

Compliance Requirements

1. The use of SMC products with production equipment for the manufacture of weapons of mass destruction (WMD) or any other weapon is strictly prohibited.
2. The exports of SMC products or technology from one country to another are governed by the relevant security laws and regulations of the countries involved in the transaction. Prior to the shipment of a SMC product to another country, assure that all local rules governing that export are known and followed.

 Safety Instructions Be sure to read “Handling Precautions for SMC Products” (M-E03-3) before using.

SMC Corporation

Akihabara UDX 15F,
4-14-1, Sotokanda, Chiyoda-ku, Tokyo 101-0021, JAPAN
Phone: 03-5207-8249 Fax: 03-5298-5362
<http://www.smcworld.com>
© 2013 SMC Corporation All Rights Reserved

Specifications are subject to change without prior notice and any obligation on the part of the manufacturer.

D-G

1st printing RP printing RP 8150SZ Printed in Japan.